

Management and Configuration Guide

2810

ProCurve Series 2810 Switches

N.11.XX

www.procurve.com



ProCurve Series 2810 Switches

July 2007

Management and Configuration Guide

© Copyright 2000-2007 Hewlett-Packard Development Company, L.P. The information contained herein is subject to change without notice.

Publication Number

5991-4732
July 2007

Applicable Products

ProCurve Switch 2810-24G - (J9021A)
ProCurve Switch 2810-48G - (J9022A)

Trademark Credits

Microsoft, Windows, and Windows NT are US registered trademarks of Microsoft Corporation.

Disclaimer

HEWLETT-PACKARD COMPANY MAKES NO WARRANTY OF ANY KIND WITH REGARD TO THIS MATERIAL, INCLUDING, BUT NOT LIMITED TO, THE IMPLIED WARRANTIES OF MERCHANTABILITY AND FITNESS FOR A PARTICULAR PURPOSE. Hewlett-Packard shall not be liable for errors contained herein or for incidental or consequential damages in connection with the furnishing, performance, or use of this material.

The only warranties for HP products and services are set forth in the express warranty statements accompanying such products and services. Nothing herein should be construed as constituting an additional warranty. HP shall not be liable for technical or editorial errors or omissions contained herein.

Hewlett-Packard assumes no responsibility for the use or reliability of its software on equipment that is not furnished by Hewlett-Packard.

Warranty

See the Customer Support/Warranty booklet included with the product.

A copy of the specific warranty terms applicable to your Hewlett-Packard products and replacement parts can be obtained from your HP Sales and Service Office or authorized dealer.

Contents

Product Documentation

About Your Switch Manual Set	xv
Feature Index	xvi

1 Getting Started

Contents	1-1
Introduction	1-2
Conventions	1-2
Feature Descriptions by Model	1-2
Command Syntax Statements	1-2
Command Prompts	1-3
Screen Simulations	1-3
Port Identity Examples	1-4
Sources for More Information	1-4
Need Only a Quick Start?	1-6
IP Addressing	1-6
To Set Up and Install the Switch in Your Network	1-6

2 Selecting a Management Interface

Contents	2-1
Overview	2-2
Advantages of Using the Menu Interface	2-3
Advantages of Using the CLI	2-4
Advantages of Using the Web Browser Interface	2-5
Advantages of Using ProCurve Manager or ProCurve Manager Plus	2-6

Custom Login Banners for the Console and Web Browser Interfaces	2-8
Banner Operation with Telnet, Serial, or SSHv2 Access	2-9
Banner Operation with Web Browser Access	2-9
Configuring and Displaying a Non-Default Banner	2-9
Example of Configuring and Displaying a Banner	2-10
Operating Notes	2-13

3 Using the Menu Interface

Contents	3-1
Overview	3-2
Starting and Ending a Menu Session	3-3
How To Start a Menu Interface Session	3-4
How To End a Menu Session and Exit from the Console:	3-5
Main Menu Features	3-7
Screen Structure and Navigation	3-9
Rebooting the Switch	3-12
Menu Features List	3-14
Where To Go From Here	3-15

4 Using the Command Line Interface (CLI)

Contents	4-1
Overview	4-2
Accessing the CLI	4-2
Using the CLI	4-2
Privilege Levels at Logon	4-3
Privilege Level Operation	4-4
Operator Privileges	4-4
Manager Privileges	4-5
How To Move Between Levels	4-7
Listing Commands and Command Options	4-8
Listing Commands Available at Any Privilege Level	4-8
Command Option Displays	4-10
Displaying CLI "Help"	4-11

Configuration Commands and the Context Configuration Modes . .	4-13
CLI Control and Editing	4-16

5 Using the Web Browser Interface

Contents	5-1
Overview	5-2
General Features	5-3
Starting a Web Browser Interface Session with the Switch	5-4
Using a Standalone Web Browser in a PC or UNIX Workstation	5-4
Using ProCurve Manager (PCM) or ProCurve Manager Plus (PCM+) .	5-5
Tasks for Your First Web Browser Interface Session	5-7
Viewing the “First Time Install” Window	5-7
Creating Usernames and Passwords in the Browser Interface	5-8
Using the Passwords	5-10
Using the User Names	5-10
If You Lose a Password	5-11
Online Help for the Web Browser Interface	5-11
Support/Mgmt URLs Feature	5-12
Support URL	5-13
Help and the Management Server URL	5-13
Using the PCM Server for Switch Web Help	5-15
Status Reporting Features	5-16
The Overview Window	5-16
The Port Utilization and Status Displays	5-17
Port Utilization	5-17
Port Status	5-19
The Alert Log	5-20
Sorting the Alert Log Entries	5-20
Alert Types and Detailed Views	5-21
The Status Bar	5-22
Setting Fault Detection Policy	5-23

6 Switch Memory and Configuration

Contents	6-1
Overview	6-2
Overview of Configuration File Management	6-2
Using the CLI To Implement Configuration Changes	6-5
Using the Menu and Web Browser Interfaces To Implement Configuration Changes	6-8
Configuration Changes Using the Menu Interface	6-8
Using Save and Cancel in the Menu Interface	6-9
Rebooting from the Menu Interface	6-10
Configuration Changes Using the Web Browser Interface	6-11
Using Primary and Secondary Flash Image Options	6-12
Displaying the Current Flash Image Data	6-12
Switch Software Downloads	6-14
Local Switch Software Replacement and Removal	6-15
Rebooting the Switch	6-17
Booting from the Current Software Version	6-19
Operating Notes	6-21

7 Interface Access and System Information

Contents	7-1
Overview	7-2
Interface Access: Console/Serial Link, Web, and Telnet	7-3
Menu: Modifying the Interface Access	7-4
CLI: Modifying the Interface Access	7-5
Denying Interface Access by Terminating Remote Management Sessions	7-10
System Information	7-11
Menu: Viewing and Configuring System Information	7-12
CLI: Viewing and Configuring System Information	7-13
Web: Configuring System Parameters	7-16

8 Configuring IP Addressing

Contents	8-1
Overview	8-2
IP Configuration	8-3
Just Want a Quick Start with IP Addressing?	8-4
IP Addressing with Multiple VLANs	8-4
IP Addressing in a Stacking Environment	8-5
Menu: Configuring IP Address, Gateway, and Time-To-Live (TTL) ..	8-5
CLI: Configuring IP Address, Gateway, and Time-To-Live (TTL) ...	8-7
Web: Configuring IP Addressing	8-11
How IP Addressing Affects Switch Operation	8-11
DHCP/Bootp Operation	8-12
Network Preparations for Configuring DHCP/Bootp	8-15
IP Preserve: Retaining VLAN-1 IP Addressing Across Configuration	
File Downloads	8-16
Operating Rules for IP Preserve	8-16

9 Time Protocols

Contents	9-1
Overview	9-2
TimeP Time Synchronization	9-2
SNTP Time Synchronization	9-2
Overview: Selecting a Time Synchronization Protocol or	
Turning Off Time Protocol Operation	9-3
General Steps for Running a Time Protocol on the Switch	9-3
Disabling Time Synchronization	9-3
SNTP: Viewing, Selecting, and Configuring	9-4
Menu: Viewing and Configuring SNTP	9-5
CLI: Viewing and Configuring SNTP	9-8
Viewing the Current SNTP Configuration	9-8
Configuring (Enabling or Disabling) the SNTP Mode	9-9
TimeP: Viewing, Selecting, and Configuring	9-14
Menu: Viewing and Configuring TimeP	9-15

CLI: Viewing and Configuring TimeP	9-16
Viewing the Current TimeP Configuration	9-17
Configuring (Enabling or Disabling) the TimeP Mode	9-18
SNTP Unicast Time Polling with Multiple SNTP Servers	9-21
Address Prioritization	9-21
Adding and Deleting SNTP Server Addresses	9-22
Menu Interface Operation with Multiple SNTP Server Addresses Configured	9-23
SNTP Messages in the Event Log	9-24

10 Port Status and Basic Configuration

Contents	10-1
Overview	10-3
Viewing Port Status and Configuring Port Parameters	10-3
Menu: Viewing Port Status and Configuring Port Parameters	10-5
CLI: Viewing Port Status and Configuring Port Parameters	10-7
Using the CLI To View Port Status	10-7
Viewing Transceiver Status	10-9
Displaying Spanning Tree Configuration Details	10-11
Using the CLI To Configure Ports	10-11
Using the CLI To Configure a Broadcast Limit	10-12
Configuring HP Auto-MDIX	10-13
Manual Auto-MDIX Override	10-14
Web: Viewing Port Status and Configuring Port Parameters	10-16
Jumbo Packets	10-17
Terminology	10-17
Operating Rules	10-18
Configuring Jumbo Packet Operation	10-18
Overview	10-19
Viewing the Current Jumbo Configuration	10-19
Enabling or Disabling Jumbo Traffic on a VLAN	10-21
Operating Notes for Jumbo Traffic-Handling	10-22
Troubleshooting	10-24
QoS Pass-Through Mode	10-25
General Operation	10-25
Priority Mapping With and Without QoS Pass-Through Mode ..	10-26
How to enable/disable QoS Pass-Through Mode	10-26

Configuring Port-Based Priority for Incoming Packets	10-28
The Role of 802.1Q VLAN Tagging	10-28
Outbound Port Queues and Packet Priority Settings	10-29
Operating Rules for Port-Based Priority	10-30
Configuring and Viewing Port-Based Priority	10-31
Messages Related to Prioritization	10-32
Troubleshooting Prioritization	10-32
Using Friendly (Optional) Port Names	10-33
Configuring and Operating Rules for Friendly Port Names	10-33
Configuring Friendly Port Names	10-34
Displaying Friendly Port Names with Other Port Data	10-35

11 Port Trunking

Contents	11-1
Overview	11-2
Port Status and Configuration	11-2
Port Connections and Configuration	11-3
Link Connections	11-3
Port Trunk Options and Operation	11-3
Trunk Configuration Methods	11-4
Menu: Viewing and Configuring a Static Trunk Group	11-9
CLI: Viewing and Configuring a Static or Dynamic Port Trunk Group	11-11
Using the CLI To View Port Trunks	11-11
Using the CLI To Configure a Static or Dynamic Trunk Group	11-14
Web: Viewing Existing Port Trunk Groups	11-17
Trunk Group Operation Using LACP	11-17
Default Port Operation	11-20
LACP Notes and Restrictions	11-22
Trunk Group Operation Using the “Trunk” Option	11-24
How the Switch Lists Trunk Data	11-24
Outbound Traffic Distribution Across Trunked Links	11-25

12 Configuring for Network Management Applications

Contents	12-1
Using SNMP Tools To Manage the Switch	12-3
Overview	12-3
SNMP Management Features	12-4
Configuring for SNMP Access to the Switch	12-4
Configuring for SNMP Version 3 Access to the Switch	12-5
SNMP Version 3 Commands	12-6
SNMPv3 Enable	12-7
SNMP Version 3 Users	12-8
Group Access Levels	12-11
SNMP Communities	12-12
Menu: Viewing and Configuring non-SNMP version 3 Communities	12-14
CLI: Viewing and Configuring SNMP Community Names	12-16
SNMP Notification and Traps	12-18
Trap Features	12-20
Using the CLI To Enable Authentication Traps	12-23
Advanced Management: RMON	12-24
LLDP (Link-Layer Discovery Protocol)	12-25
Terminology	12-26
General LLDP Operation	12-27
Packet Boundaries in a Network Topology	12-27
Configuration Options	12-28
Options for Reading LLDP Information Collected by the Switch ..	12-30
LLDP Standards Compatibility	12-31
LLDP Operating Rules	12-31
Configuring LLDP Operation	12-32
Viewing the Current Configuration	12-32
Configuring Global LLDP Packet Controls	12-34
Configuring SNMP Notification Support	12-38
Configuring Per-Port Transmit and Receive Modes	12-39
Configuring Basic LLDP Per-Port Advertisement Content	12-40
Displaying Advertisement Data	12-42
Displaying Switch Information Available for Outbound Advertisements	12-43
Displaying LLDP Statistics	12-47
LLDP Operating Notes	12-50

LLDP and CDP Data Management	12-51
LLDP and CDP Neighbor Data	12-51
CDP Operation and Commands	12-53

A File Transfers

Contents	A-1
Overview	A-2
Downloading Switch Software	A-2
General Switch Software Download Rules	A-3
Using TFTP To Download Switch Software from a Server	A-3
Menu: TFTP Download from a Server to Primary Flash	A-4
CLI: TFTP Download from a Server to Primary or Secondary Flash	A-6
Using Secure Copy and SFTP	A-7
How It Works	A-8
The SCP/SFTP Process	A-9
Command Options	A-9
Authentication	A-10
SCP/SFTP Operating Notes	A-10
Using Xmodem to Download Switch Software From a PC or UNIX Workstation	A-11
Menu: Xmodem Download to Primary Flash	A-12
CLI: Xmodem Download from a PC or Unix Workstation to Primary or Secondary Flash	A-13
Switch-to-Switch Download	A-14
Menu: Switch-to-Switch Download to Primary Flash	A-14
CLI: Switch-To-Switch Downloads	A-15
Using ProCurve Manager Plus to Update Switch Software	A-16
Troubleshooting TFTP Downloads	A-17
Transferring Switch Configurations	A-18
Copying Diagnostic Data to a Remote Host, PC, or Unix Workstation .	A-21
Copying Command Output to a Destination Device	A-21
Copying Event Log Output to a Destination Device	A-22
Copying Crash Data Content to a Destination Device	A-22
Copying Crash Log Data Content to a Destination Device	A-23

B Monitoring and Analyzing Switch Operation

Contents	B-1
Overview	B-3
Status and Counters Data	B-4
Menu Access To Status and Counters	B-5
General System Information	B-6
Menu Access	B-6
CLI Access	B-6
Switch Management Address Information	B-7
Menu Access	B-7
CLI Access	B-7
Module Information	B-8
Menu: Displaying Port Status	B-8
CLI Access	B-8
Port Status	B-9
Menu: Displaying Port Status	B-9
CLI Access	B-9
Web Access	B-9
Viewing Port and Trunk Group Statistics and Flow Control Status	B-10
Menu Access to Port and Trunk Statistics	B-11
CLI Access To Port and Trunk Group Statistics	B-12
Web Browser Access To View Port and Trunk Group Statistics	B-12
Viewing the Switch's MAC Address Tables	B-13
Menu Access to the MAC Address Views and Searches	B-13
CLI Access for MAC Address Views and Searches	B-16
Spanning Tree Protocol (STP) Information	B-17
Menu Access to STP Data	B-17
CLI Access to STP Data	B-18
Internet Group Management Protocol (IGMP) Status	B-19
VLAN Information	B-20
Web Browser Interface Status Information	B-22
Port and Static Trunk Monitoring Features	B-23
Menu: Configuring Port and Static Trunk Monitoring	B-24
CLI: Configuring Port and Static Trunk Monitoring	B-26
Web: Configuring Port Monitoring	B-28
Locating a Device	B-28

C Troubleshooting

Contents	C-1
Overview	C-3
Troubleshooting Approaches	C-3
Chassis Over-Temperature Detection	C-5
Browser or Telnet Access Problems	C-7
Unusual Network Activity	C-9
General Problems	C-9
Prioritization Problems	C-10
IGMP-Related Problems	C-10
LACP-Related Problems	C-11
Port-Based Access Control (802.1X)-Related Problems	C-12
Radius-Related Problems	C-15
Spanning-Tree Protocol (STP) and Fast-Uplink Problems	C-16
SSH-Related Problems	C-17
Stacking-Related Problems	C-18
TACACS-Related Problems	C-18
TimeP, SNTP, or Gateway Problems	C-20
VLAN-Related Problems	C-20
Using Logging To Identify Problem Sources	C-23
Event Log Operation	C-23
Menu: Entering and Navigating in the Event Log	C-25
CLI:	C-26
Debug and Syslog Operation	C-27
Diagnostic Tools	C-34
Port Auto-Negotiation	C-34
Ping and Link Tests	C-35
Web: Executing Ping or Link Tests	C-36
CLI: Ping or Link Tests	C-37
Displaying the Configuration File	C-39
CLI: Viewing the Configuration File	C-39
Web: Viewing the Configuration File	C-39
Listing Switch Configuration and Operation Details for Help in Troubleshooting	C-40
CLI Administrative and Troubleshooting Commands	C-42

Restoring the Factory-Default Configuration	C-43
Using the CLI	C-43
Using the Clear/Reset Buttons	C-43
Restoring a Flash Image	C-44

D MAC Address Management

Contents	D-1
Overview	D-2
Determining MAC Addresses in the Switch	D-2
Menu: Viewing the Switch's MAC Addresses	D-3
CLI: Viewing the Port and VLAN MAC Addresses	D-4
Viewing the MAC Addresses of Connected Devices	D-6

E Daylight Savings Time on ProCurve Switches

Configuring Daylight Savings Time	E-1
---	-----

Index

Product Documentation

About Your Switch Manual Set

The switch manual set includes the following:

- **Read Me First** - a printed guide shipped with your switch. Provides software update information, product notes, and other information.
- **Installation and Getting Started Guide** - a printed guide shipped with your switch. This guide explains how to prepare for and perform the physical installation and connection to your network.
- **Management and Configuration Guide** - a PDF file on the ProCurve Networking website. This guide describes how to configure, manage, and monitor basic switch operation.
- **Advanced Traffic Management Guide** - a PDF file on the ProCurve Networking website. This guide explains the configuration and operation of traffic management features such as spanning tree and VLANs.
- **Access Security Guide** - a PDF file on the ProCurve Networking website. This guide explains the configuration and operation of access security and user authentication features on the switch.
- **Release Notes** - posted on the ProCurve web site to provide information on software updates. The release notes describe new features, fixes, and enhancements that become available between revisions of the above guides.

Note

For the latest version of all ProCurve switch documentation, including release notes covering recently added features, visit the ProCurve Networking website at <http://www.procurve.com>. Click on **Technical support**, and then click on **Product manuals**.

Feature Index

For the manual set supporting your switch model, the following feature index indicates which manual to consult for information on a given software feature. (Note that some software features are not supported on all switch models.)

Feature	Management and Configuration	Advanced Traffic Management	Access Security Guide
802.1Q VLAN Tagging	-	X	-
802.1p Priority	X	-	-
802.1X Authentication	-	-	X
Authorized IP Managers	-	-	X
Config File	X	-	-
Copy Command	X	-	-
Debug	X	-	-
DHCP Configuration	-	X	-
DHCP/Bootp Operation	X	-	-
Diagnostic Tools	X	-	-
Downloading Software	X	-	-
Event Log	X	-	-
Factory Default Settings	X	-	-
File Management	X	-	-
File Transfers	X	-	-
GVRP	-	X	-
IGMP	-	X	-
Interface Access (Telnet, Console/Serial, Web)	X	-	-
IP Addressing	X	-	-
LACP	X	-	-

Feature	Management and Configuration	Advanced Traffic Management	Access Security Guide
Link	X	-	-
LLDP	X	-	-
MAC Address Management	X	-	-
MAC Lockdown	-	-	X
MAC Lockout	-	-	X
MAC-based Authentication	-	-	X
Monitoring and Analysis	X	-	-
Multicast Filtering	-	X	-
Network Management Applications (LLDP, SNMP)	X	-	-
Passwords	-	-	X
Ping	X	-	-
Port Configuration	X	-	-
Port Security	-	-	X
Port Status	X	-	-
Port Trunking (LACP)	X	-	-
Port-Based Access Control	-	-	X
Port-Based Priority (802.1Q)	X	-	-
Quality of Service (QoS)	-	X	-
RADIUS Authentication and Accounting	-	-	X
Secure Copy	X	-	-
SFTP	X	-	-
SNMP	X	-	-
Software Downloads (SCP/SFTP, TFTP, Xmodem)	X	-	-
Source-Port Filters	-	-	X
Spanning Tree (MSTP)	-	X	-
SSH (Secure Shell) Encryption	-	-	X

Product Documentation

Feature	Management and Configuration	Advanced Traffic Management	Access Security Guide
SSL (Secure Socket Layer)	-	-	X
Stack Management (Stacking)	-	X	-
Syslog	X	-	-
System Information	X	-	-
TACACS+ Authentication	-	-	X
Telnet Access	X	-	-
TFTP	X	-	-
Time Protocols (TimeP, SNTP)	X	-	-
Traffic/Security Filters	-	-	X
Troubleshooting	X	-	-
VLANs	-	X	-
Web-based Authentication	-	-	X
Xmodem	X	-	-

Getting Started

Contents

Introduction	1-2
Conventions	1-2
Feature Descriptions by Model	1-2
Command Syntax Statements	1-2
Command Prompts	1-3
Screen Simulations	1-3
Port Identity Examples	1-4
Sources for More Information	1-4
Need Only a Quick Start?	1-6
IP Addressing	1-6
To Set Up and Install the Switch in Your Network	1-6

Introduction

This *Management and Configuration Guide* is intended to support the following switches:

- ProCurve Series 2810

This guide describes how to use the command line interface (CLI), menu interface, and web browser interface to configure, manage, and monitor switch operation. A troubleshooting chapter is also included.

For an overview of other product documentation for the above switches, refer to “Product Documentation” on page xv.

You can download a copy from the ProCurve website, <http://www.procurve.com>.

Conventions

This guide uses the following conventions for command syntax and displayed information.

Feature Descriptions by Model

In cases where a software feature is not available in all of the switch models covered by this guide, the section heading specifically indicates which product or product series offer the feature.

For example (the switch model is highlighted here in ***bold italics***):

“QoS Pass-Through Mode on the ***2810 Switches***”.

Command Syntax Statements

Syntax: `aaa port-access authenticator < port-list >
[control < authorized | auto | unauthorized >]`

- Vertical bars (|) separate alternative, mutually exclusive elements.
 - Square brackets ([]) indicate optional elements.
-

- Braces (< >) enclose required elements.
- Braces within square brackets ([< >]) indicate a required element within an optional choice.
- Boldface indicates use of a CLI command, part of a CLI command syntax, or other displayed element in general text. For example:

“Use the **copy tftp** command to download the key from a TFTP server.”
- Italics indicate variables for which you must supply a value when executing the command. For example, in this command syntax, **< port-list >** indicates that you must provide one or more port numbers:

Syntax: aaa port-access authenticator < *port-list* >

Command Prompts

In the default configuration, your switch displays one of the following CLI prompts:

```
ProCurve Switch 2810#
```

To simplify recognition, this guide uses `ProCurve` to represent command prompts for all models. For example:

```
ProCurve#
```

(You can use the **hostname** command to change the text in the CLI prompt.)

Screen Simulations

Figures containing simulated screen text and command output look like this:

```
ProCurve(config)# show version
Image stamp:      /sw/code/build/bass(ppne_swt)
                  Mar 17 2006 11:44:02
                  N.10.XX
                  2624
Boot Image:       Primary
Build Options:    QA
Watchdog:         ENABLED
```

Figure 1-1. Example of a Figure Showing a Simulated Screen

In some cases, brief command-output sequences appear outside of a numbered figure. For example:

```
ProCurve(config)# ip default-gateway 18.28.152.1/24
ProCurve(config)# vlan 1 ip address 18.28.36.152/24
ProCurve(config)# vlan 1 ip igmp
```

Port Identity Examples

This guide describes software applicable to both chassis-based and stackable ProCurve switches. Where port identities are needed in an example, this guide uses the chassis-based port identity system, such as “A1”, “B3 - B5”, “C7”, etc. However, unless otherwise noted, such examples apply equally to the stackable switches, which for port identities typically use only numbers, such as “1”, “3-5”, “15”, etc.

Sources for More Information

For additional information about switch operation and features not covered in this guide, consult the following sources:

- For information on which product manual to consult on a given software feature, refer to “Product Documentation” on page xv.

Note

For the latest version of all ProCurve switch documentation, including release notes covering recently added features, visit the ProCurve Networking website at <http://www.procurve.com>. Click on **Technical support**, and then click on **Product manuals**.

- For information on specific parameters in the menu interface, refer to the online help provided in the interface. For example:

```
----- CONSOLE - MANAGER MODE -----  
Switch Configuration - Internet (IP) Service  
  
Default Gateway : 10.35.204.1  
Default TTL      : 64  
  
IP Config [DHCP/Bootp] : Manual  
IP Address       : 10.35.204.104  
Subnet Mask      : 255.255.240.0  
  
Actions->  _Cancel      _Edit      _Save      Help  
  
Display help information.  
Use arrow keys to change action selection and <Enter> to execute action.
```

Figure 1-2. Getting Help in the Menu Interface

- For information on a specific command in the CLI, type the command name followed by “help”. For example:

```
ProCurve# write help  
Usage: write <memory|terminal>  
  
Description: View or save the running configuration of the switch.  
  
write terminal - displays the running configuration of the  
                switch on the terminal  
write memory   - saves the running configuration of the  
                switch to flash. The saved configuration  
                becomes the boot-up configuration of the switch  
                the next time it is booted.
```

Figure 1-3. Getting Help in the CLI

- For information on specific features in the Web browser interface, use the online help. For information on Help options, see “Online Help for the Web Browser Interface” on page 5-1.
- For further information on ProCurve Networking switch technology, visit the ProCurve website at:

<http://www.procurve.com>

Need Only a Quick Start?

IP Addressing

If you just want to give the switch an IP address so that it can communicate on your network, or if you are not using multiple VLANs, ProCurve recommends that you use the Switch Setup screen to quickly configure IP addressing. To do so, do one of the following:

- Enter **setup** at the CLI Manager level prompt.

```
ProCurve# setup
```
- In the Main Menu of the Menu interface, select
8. Run Setup

For more on using the Switch Setup screen, see the *Installation and Getting Started Guide* you received with the switch.

To Set Up and Install the Switch in Your Network

Important!

Use the *Quick Installation Guide* shipped with your switch for the following:

- Notes, cautions, and warnings related to installing and using the switch
- Instructions for physically installing the switch in your network
- Quickly assigning an IP address and subnet mask, setting a Manager password, and (optionally) configuring other basic features.
- Interpreting LED behavior.

For the latest version of the *Installation and Getting Started Guide* and other documentation for your switch, visit the ProCurve Networking Web site. (Refer to “Product Documentation” on page xv of this guide for further details.)

Selecting a Management Interface

Contents

Overview	2-2
Advantages of Using the Menu Interface	2-3
Advantages of Using the CLI	2-4
Advantages of Using the Web Browser Interface	2-5
Advantages of Using ProCurve Manager or ProCurve Manager Plus	2-6
Custom Login Banners for the Console and Web Browser Interfaces	2-8
Banner Operation with Telnet, Serial, or SSHv2 Access	2-9
Banner Operation with Web Browser Access	2-9
Configuring and Displaying a Non-Default Banner	2-9
Example of Configuring and Displaying a Banner	2-10
Operating Notes	2-13

Overview

Management interfaces enable you to reconfigure the switch and to monitor switch status and performance. Interface types include:

- **Menu interface**—a menu-driven interface offering a subset of switch commands through the built-in VT-100/ANSI console—**page 2-3**
- **CLI**—a command line interface offering the full set of switch commands through the VT-100/ANSI console built into the switch—**page 2-4**
- **Web browser interface**—a switch interface offering status information and a subset of switch commands through a standard web browser (such as Netscape Navigator or Microsoft Internet Explorer)—**page 2-5**
- **ProCurve Manager (PCM)**—a windows-based network management solution included in-box with all manageable ProCurve devices. Features include automatic device discovery, network status summary, topology and mapping, and device management.
- **ProCurve Manager Plus (PCM+)**—a complete windows-based network management solution that provides both the basic features offered with PCM, as well as more advanced management features, including in-depth traffic analysis, group and policy management, configuration management, device software updates, and advanced VLAN management. (ProCurve includes a copy of PCM+ in-box for a free 30-day trial.)

This manual describes how to use the menu interface (chapter 3), the CLI (chapter 4), the web browser interface (chapter 5), and how to use these interfaces to configure and monitor the switch.

For information on how to access the web browser interface Help, refer to “Online Help for the Web Browser Interface” on page 5-11.

To use ProCurve Manager or ProCurve Manager Plus, refer to the *Getting Started Guide* and the *Administrator’s Guide*, which are available electronically with the software for these applications. For more information, visit the ProCurve web site at <http://www.procurve.com>.

Advantages of Using the Menu Interface

```
===== CONSOLE - MANAGER MODE =====
                          Main Menu

1. Status and Counters...
2. Switch Configuration...
3. Console Passwords...
4. Event Log
5. Command Line (CLI)
6. Reboot Switch
7. Download OS
8. Run Setup
9. Stacking...
0. Logout

Provides the menu to display configuration, status, and counters.
To select menu item, press item number, or highlight item and press <Enter>.
```

Figure 2-1. Example of the Console Interface Display

- **Provides quick, easy management access** to a menu-driven subset of switch configuration and performance features:

- IP addressing
- VLANs and GVRP
- Port Security
- Port and Static Trunk Group
- Stack Management
- Spanning Tree
- System information
- Passwords
- SNMP communities
- Time protocols

The menu interface also provides access for:

- Setup screen
 - Event Log display
 - Switch and port status displays
 - Switch and port statistic and counter displays
 - Reboots
 - Software downloads
- **Offers out-of-band access** (through the RS-232 connection) to the switch, so network bottlenecks, crashes, lack of configured or correct IP address, and network downtime do not slow or prevent access
 - **Enables Telnet (in-band) access** to the menu functionality.

- **Allows faster navigation**, avoiding delays that occur with slower display of graphical objects over a web browser interface.
- **Provides more security**; configuration information and passwords are not seen on the network.

Advantages of Using the CLI

ProCurve>	Operator Level
ProCurve#	Manager Level
ProCurve(config)#	Global Configuration Level
ProCurve(<context>)#	Context Configuration Levels (port, VLAN)

Figure 2-2. Command Prompt Examples

- Provides access to the complete set of the switch configuration, performance, and diagnostic features.
- Offers out-of-band access (through the RS-232 connection) or Telnet (in-band) access.
- Enables quick, detailed system configuration and management access to system operators and administrators experienced in command prompt interfaces.
- Provides help at each level for determining available options and variables.

CLI Usage

- For information on how to use the CLI, refer to chapter 3. “Using the Menu Interface”.
- To perform specific procedures (such as configuring IP addressing or VLANs), use the Contents listing at the front of the manual to locate the information you need.
- For monitoring and analyzing switch operation, refer to appendix B.
- For information on individual CLI commands, refer to the Index or to the online Help provided in the CLI interface.

Advantages of Using the Web Browser Interface

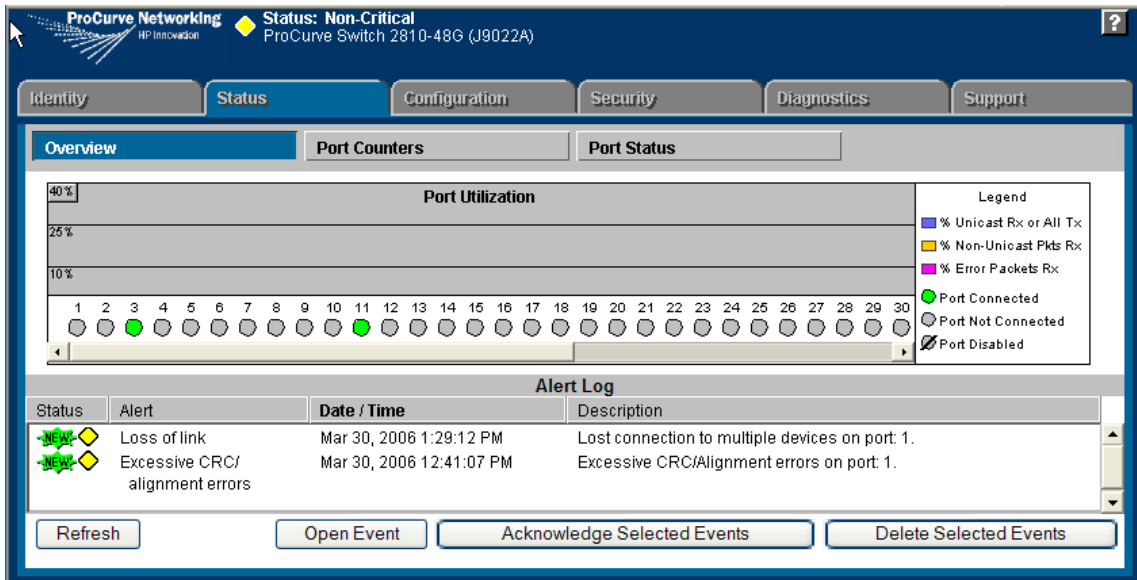

Figure 2-3. Example of the Web Browser Interface

- **Easy access** to the switch from anywhere on the network
- **Familiar browser interface**—locations of window objects consistent with commonly used browsers, uses mouse clicking for navigation, no terminal setup
- **Many features have all their fields in one screen** so you can view all values at once
- **More visual cues**, using colors, status bars, device icons, and other graphical objects instead of relying solely on alphanumeric values
- **Display of acceptable ranges of values available** in configuration list boxes

Advantages of Using ProCurve Manager or ProCurve Manager Plus

You can operate ProCurve Manager and ProCurve Manager Plus (PCM and PCM+) from a PC on the network to monitor traffic, manage your hubs and switches, and proactively recommend network changes to increase network uptime and optimize performance. Easy to install and use, PCM and PCM+ are the answers to your management challenges.

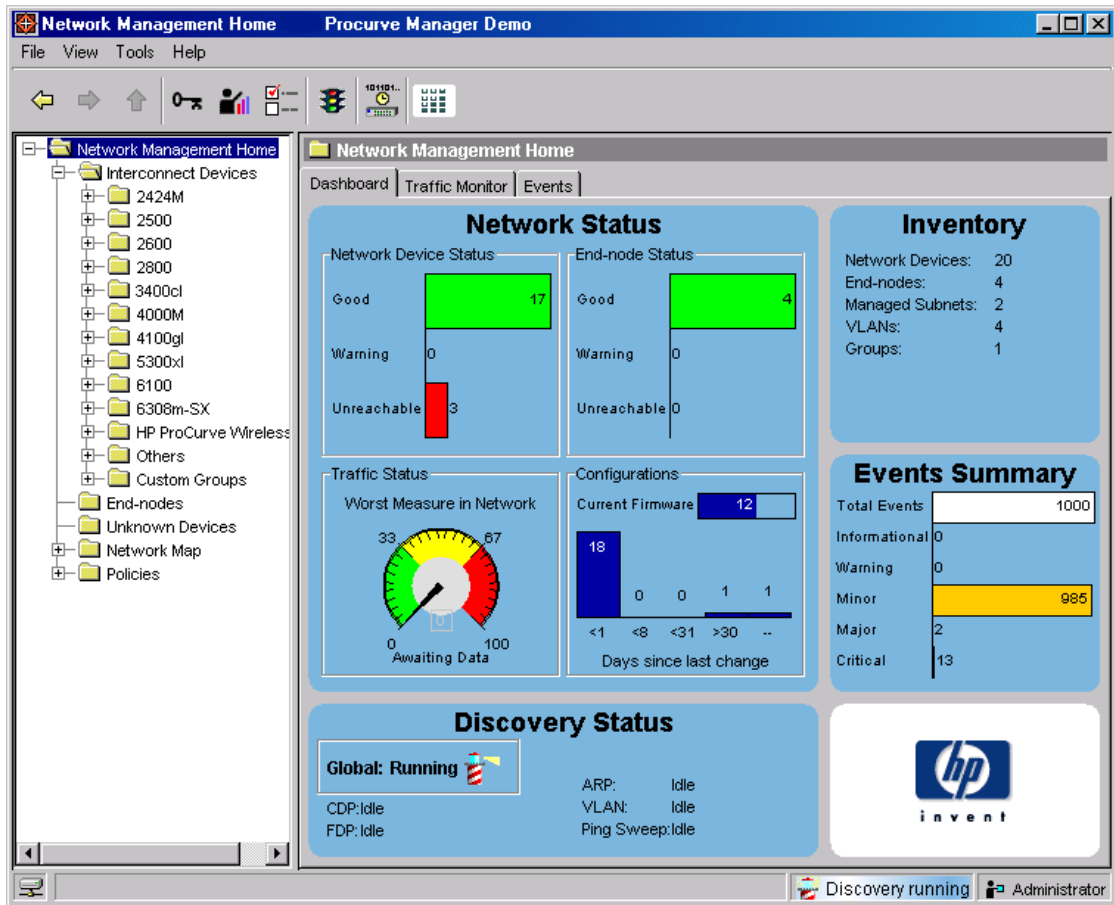

Figure 2-4. Example of the Home Page for ProCurve Manager Plus

PCM and PCM+ enable greater control, uptime, and performance in your network:

- Features and benefits of ProCurve Manager:
 - **Network Status Summary:** Upon boot-up, a network status screen displays high-level information on network devices, end nodes, events, and traffic levels. From here, users can research any one of these areas to get more details.
 - **Alerts and Troubleshooting:** An events summary screen displays alerts to the user and categorizes them by severity, making it easier to track where bottlenecks and issues exist in the network. Alerts present detailed information on the problem, even down to the specific port.
 - **Automatic Device Discovery:** This feature is customized for fast discovery of all ProCurve manageable network devices. The user can define which IP subnets to discover.
 - **Topology and Mapping:** This feature automatically creates a map of discovered network devices. Maps are color-coded to reflect device status and can be viewed at multiple levels (physical view, subnet view, or VLAN view).
 - **Device Management:** Many device-focused tasks can be performed directly by the software, or the user can access web-browser and command-line interfaces with the click of a button to manage individual devices from inside the tool.
- Features and benefits of ProCurve Manager Plus:
 - **All of the Features of ProCurve Manager:** Refer to the above listing.
 - **In-Depth Traffic Analysis:** An integrated, low-overhead traffic monitor interface shows detailed information on traffic throughout the network. Using enhanced traffic analysis protocols such as Extended RMON and sFlow, users can monitor overall traffic levels, segments with the highest traffic, or even the top users within a network segment.
 - **Group and Policy Management:** Changes in configuration are tracked and logged, and archived configurations can be applied to one or many devices. Configurations can be compared over time or between two devices, with the differences highlighted for users.
 - **Advanced VLAN Management:** A new, easy-to-use VLAN management interface allows users to create and assign VLANs across the entire network, without having to access each network device individually.

Selecting a Management Interface

Advantages of Using ProCurve Manager or ProCurve Manager Plus

- **Device Software Updates:** This feature automatically obtains new device software images from ProCurve and updates devices, allowing users to download the latest version or choose the desired version. Updates can be scheduled easily across large groups of devices, all at user-specified times.
- **Investment Protection:** The modular software architecture of ProCurve Manager Plus enables ProCurve to offer network administrators add-on software solutions that complement their needs.

Custom Login Banners for the Console and Web Browser Interfaces

You can now configure the switch to display a login banner of up to 320 characters when an operator initiates a management session with the switch through any of the following methods:

- Telnet
- serial connection
- SSHv2
- Web browser

In the factory default configuration, the switch displays the following default banner:

```

                                RESTRICTED RIGHTS LEGEND

Use, duplication, or disclosure by the Government is subject to restrictions
as set forth in subdivision (b) (3) (ii) of the Rights in Technical Data and
Computer Software clause at 52.227-7013.

                                HEWLETT-PACKARD COMPANY, 3000 Hanover St., Palo Alto, CA 94303

-----
We'd like to keep you up to date about:
 * Software feature updates
 * New product announcements
 * Special events
-----
Please register your products now at:  www.ProCurve.com
-----

Password: █

```

Default banner appearing

Figure 2-5. The Default Login Banner

Note

The switch's Web browser interface does not display the default banner.

Banner Operation with Telnet, Serial, or SSHv2 Access

When a system operator begins a login session, the switch displays the banner above the local password prompt or, if no password is configured, above the **Press any key to continue prompt**. Entering a correct password or, if no password is configured, pressing any key clears the banner from the CLI and displays the CLI prompt. (Refer to figure 2-5 on page 2-8.)

Banner Operation with Web Browser Access

When a system operator uses a Web browser to access the switch, the text of a non-default banner configured on the switch appears in a dedicated banner window with a link to the Web agent home page. Clicking on **To Home Page** clears the banner window and prompts the user for a password (if configured). Following entry of the correct username/password information (or if no username/password is required), the switch then displays either the Registration page or the switch's home page. Note that if the banner feature is disabled or if the switch is using the factory-default banner shown in figure 2-5, then the banner page does not appear in the Web browser when an operator initiates a login session with the switch.

Configuring and Displaying a Non-Default Banner

You can enable or disable banner operation using either the switch's CLI or an SNMP application. The steps include:

1. Enable non-default banner operation and define the endpoint delimiter for the banner.
2. Enter the desired banner text, including any specific line breaks you want.
3. Enter the endpoint delimiter.

Selecting a Management Interface

Advantages of Using ProCurve Manager or ProCurve Manager Plus

Use **show banner motd** to display the current banner status.

Syntax: banner motd < delimiter >
no banner motd

*This command defines the single character used to terminate the banner text and enables banner text input. You can use any character except a blank space as a delimiter. The **no** form of the command disables the login banner feature.*

< banner-text-string >

*The switch allows up to 320 banner characters, including blank spaces and CR-LF ([Enter]). (The tilde “~” and the delimiter defined by **banner motd <delimiter>** are not allowed as part of the banner text.) While entering banner text, you can backspace to edit the current line (that is, a line that has not been terminated by a CR-LF.) However, terminating a line in a banner by entering a CR-LF prevents any further editing of that line. To edit a line in a banner entry after terminating the line with a CR-LF requires entering the delimiter described above and then re-configuring new banner text.*

*The banner text string must terminate with the character defined by **banner motd < delimiter >**.*

Example of Configuring and Displaying a Banner

Suppose a system operator wanted to configure the following banner message on her company’s switches:

```
This is a private system maintained by the
      Allied Widget Corporation.
Unauthorized use of this system can result in
      civil and criminal penalties!
```

In this case, the operator will use the [Enter] key to create line breaks, blank spaces for line centering, and the % symbol to terminate the banner message.

```
ProCurve(config)# banner motd %
Enter TEXT message. End with the character '%'
      This is a private system maintained by the
        Allied Widget Corporation.
      Unauthorized use of this system can result in
        civil and criminal penalties!%
ProCurve(config)# write memory
```

Figure 1. Example of Configuring a Login Banner

To view the current banner configuration, use either the **show banner motd** or **show running** command.

```
ProCurve(config)# show banner motd

Banner Information

Banner status: Enabled
Configured Banner:

      This is a private system maintained by the
        Allied Widget Corporation.
      Unauthorized use of this system can result in
        civil and criminal penalties!
```

Figure 2. Example of show banner motd Output

Selecting a Management Interface

Advantages of Using ProCurve Manager or ProCurve Manager Plus

```
ProCurve(config)# show running

Running configuration:

; J9220A Configuration Editor; Created on release # N.10.XX

hostname "ProCurve"
snmp-server community "notpublic" Unrestricted
vlan 1
  name "DEFAULT_VLAN"
  untagged 1-24
  ip address dhcp-bootp
  exit
banner motd "   This is a private system maintained by the
                Allied Widget Corporation.
                Unauthorized use of this system can result in
                civil and criminal penalites!"
password manager
password operator
```

Figure 3. The Current Banner Appears in the Switch's Running-Config File

The next time someone logs onto the switch's management CLI, the following appears:

```
Copyright (C) 1991-2006 Hewlett-Packard Co. All Rights Reserved.

                RESTRICTED RIGHTS LEGEND

Use, duplication, or disclosure by the Government is subject to restrictions
as set forth in subdivision (b) (3) (ii) of the Rights in Technical Data and
Computer Software clause at 52.227-7013.

                HEWLETT-PACKARD COMPANY, 3000 Hanover St., Palo Alto, CA 94303

┌-----┐
│ This is a private system maintained by the          │
│ Allied Widget Corporation.                          │
│ Unauthorized use of this system can result in      │
│ civil and criminal penalties!                      │
└-----┘
Password: █
```

The login screen displays the configured banner.
Entering a correct password clears the banner and displays the CLI prompt.

Figure 4. Example of CLI Result of the Login Banner Configuration

If someone uses a Web browser to log in to the switch interface, the following message appears:

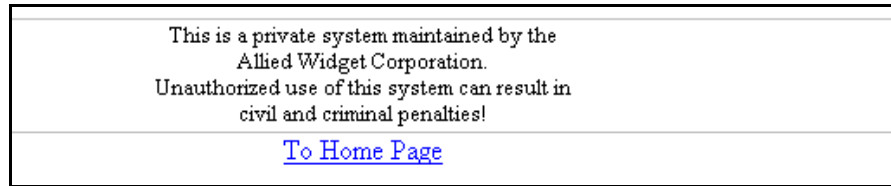

Figure 5. Example of Web Browser Interface Result of the Login Banner Configuration

Operating Notes

- The default banner appears only when the switch is in the factory default configuration. Using **no banner motd** deletes the currently configured banner text and blocks display of the default banner. The default banner is restored only if the switch is reset to its factory-default configuration.
- The switch supports one banner at any time. Configuring a new banner replaces any former banner configured on the switch.
- If the switch is configured with **ssh version 1** or **ssh version 1-or-2**, configuring the banner sets the SSH configuration to ssh version 2 and displays the following message in the CLI:

```
Warning: SSH version has been set to v2.
```
- If a banner is configured, the switch does not allow configuration with **ssh version 1** or **ssh version 1-or-2**. Attempting to do so produces the following error message in the CLI:

```
Banner has to be disabled first.
```
- If a banner is enabled on the switch, the Web browser interface displays the following link to the banner page:

Notice to all users

Selecting a Management Interface

Advantages of Using ProCurve Manager or ProCurve Manager Plus

Using the Menu Interface

Contents

Overview	3-2
Starting and Ending a Menu Session	3-3
How To Start a Menu Interface Session	3-4
How To End a Menu Session and Exit from the Console:	3-5
Main Menu Features	3-7
Screen Structure and Navigation	3-9
Rebooting the Switch	3-12
Menu Features List	3-14
Where To Go From Here	3-15

Overview

This chapter describes the following:

- Overview of the Menu Interface
- Starting and ending a Menu session (page 3-3)
- The Main Menu (page 3-7)
- Screen structure and navigation (page 3-9)
- Rebooting the switch (page 3-12)

The menu interface operates through the switch console to provide you with a subset of switch commands in an easy-to-use menu format enabling you to:

- Perform a quick configuration of basic parameters, such as the IP addressing needed to provide management access through your network
- Configure these features:
 - Manager and Operator passwords
 - System parameters
 - IP addressing
 - Time protocol
 - Ports
 - Trunk groups
 - A network monitoring port
 - Stack Management
 - Spanning Tree operation
 - SNMP community names
 - IP authorized managers
 - VLANs (Virtual LANs) and GVRP
- View status, counters, and Event Log information
- Update switch software
- Reboot the switch

For a detailed list of menu features, see the “Menu Features List” on page 3-14.

Privilege Levels and Password Security. *ProCurve strongly recommends that you configure a Manager password to help prevent unauthorized access to your network.* A Manager password grants full read-write access to the switch. An Operator password, if configured, grants access to status and counter, Event Log, and the Operator level in the CLI. After you configure passwords on the switch and log off of the interface, access to the menu interface (and the CLI and web browser interface) will require entry of either the Manager or Operator password. (If the switch has only a Manager password, then someone without a password can still gain read-only access.)

Note

If the switch has neither a Manager nor an Operator password, anyone having access to the console interface can operate the console with full manager privileges. Also, if you configure only an Operator password, entering the Operator password enables full manager privileges.

For more information on passwords, see the chapter on local passwords in the Access Security Guide for your switch.

- The menu interface displays the current running-config parameter settings. You can use the menu interface to save configuration changes made in the CLI only if the CLI changes are in the running config when you save changes made in the menu interface. (For more on how switch memory manages configuration changes, see Chapter 6, “Switch Memory and Configuration”.)
- A configuration change made through any switch interface overwrites earlier changes made through any other interface.
- The Menu Interface and the CLI (Command Line Interface) both use the switch console. To enter the menu from the CLI, use the **menu** command. To enter the CLI from the Menu interface, select **Command Line (CLI)** option.

Starting and Ending a Menu Session

You can access the menu interface using any of the following:

- A direct serial connection to the switch’s console port, as described in the installation guide you received with the switch
- A Telnet connection to the switch console from a networked PC or the switch’s web browser interface. Telnet requires that an IP address and subnet mask compatible with your network have already been configured on the switch.
- The stack Commander, if the switch is a stack member

Note

This section assumes that either a terminal device is already configured and connected to the switch (see the *Installation and Getting Started Guide* shipped with your switch) or that you have already configured an IP address on the switch (required for Telnet access).

How To Start a Menu Interface Session

In its factory default configuration, the switch console starts with the CLI prompt. To use the menu interface with Manager privileges, go to the Manager level prompt and enter the **menu** command.

1. Use one of these methods to connect to the switch:

- A PC terminal emulator or terminal
- Telnet

(You can also use the stack Commander if the switch is a stack member).

2. Do one of the following:

- If you are using Telnet, go to step 3.
- If you are using a PC terminal emulator or a terminal, press **[Enter]** one or more times until a prompt appears.

3. When the switch screen appears, do one of the following:

- If a password has been configured, the password prompt appears.

```
Password: _
```

Type the Manager password and press **[Enter]**. Entering the Manager password gives you manager-level access to the switch. (Entering the Operator password gives you operator-level access to the switch. Refer to the chapter on local manager and operator usernames and passwords in the *Access Security Guide* for your switch.)

- If no password has been configured, the CLI prompt appears. Go to the next step.

4. When the CLI prompt appears, display the Menu interface by entering the **menu** command. For example:

```
ProCurve# menu [Enter]
```

results in:

```
----- CONSOLE - MANAGER MODE -----  
Main Menu  
  
1. Status and Counters...  
2. Switch Configuration...  
3. Console Passwords...  
4. Event Log  
5. Command Line (CLI)  
6. Reboot Switch  
7. Download OS  
8. Run Setup  
9. Stacking...  
0. Logout  
  
Provides the menu to display configuration, status, and counters.  
To select menu item, press item number, or highlight item and press <Enter>.
```

Figure 3-1. The Main Menu with Manager Privileges

For a description of Main Menu features, see “Main Menu Features” on page 3-7.

Note

To configure the switch to start with the menu interface instead of the CLI, go to the Manager level prompt in the CLI, enter the **setup** command, and in the resulting display, change the **Logon Default** parameter to **Menu**. For more information, see the *Installation and Getting Started Guide* you received with the switch.

How To End a Menu Session and Exit from the Console:

The method for ending a menu session and exiting from the console depends on whether, during the session, you made any changes to the switch configuration that require a switch reboot to activate. (Most changes via the menu interface need only a **Save**, and do not require a switch reboot.) Configuration changes needing a reboot are marked with an asterisk (*) next to the configured item in the menu and also next to the **Switch Configuration** item in the Main Menu.

Asterisk indicates a configuration change that requires a reboot to activate.

```
----- CONSOLE - MANAGER MODE -----  
Main Menu  
  
1. Status and Counters...  
*2. Switch Configuration...  
3. Console Passwords...  
4. Event Log  
5. Command Line (CLI)  
6. Reboot Switch  
7. Download OS  
8. Run Setup  
9. Stacking...  
0. Logout  
  
Displays the menu for customizing the switch configuration.  
To select menu item, press item number, or highlight item and press <Enter>.  
(*Needs reboot to activate changes.)
```

Figure 3-2. An Asterisk Indicates a Configuration Change Requiring a Reboot

1. In the current session, if you have not made configuration changes that require a switch reboot to activate, return to the Main Menu and press **[0]** (zero) to log out. Then just exit from the terminal program, turn off the terminal, or quit the Telnet session.
2. If you *have* made configuration changes that require a switch reboot—that is, if an asterisk (*) appears next to a configured item or next to **Switch Configuration** in the Main Menu:
 - a. Return to the Main Menu.
 - b. Press **[6]** to select **Reboot Switch** and follow the instructions on the reboot screen.

Rebooting the switch terminates the menu session, and, if you are using Telnet, disconnects the Telnet session.

(See “Rebooting To Activate Configuration Changes” on page 3-13.)

3. Exit from the terminal program, turn off the terminal, or close the Telnet application program.

Main Menu Features

```
===== CONSOLE - MANAGER MODE =====
                          Main Menu

1. Status and Counters...
2. Switch Configuration...
3. Console Passwords...
4. Event Log
5. Command Line (CLI)
6. Reboot Switch
7. Download OS
8. Run Setup
9. Stacking...
0. Logout

Provides the menu to display configuration, status, and counters.
To select menu item, press item number, or highlight item and press <Enter>.
```

Figure 3-3. The Main Menu View with Manager Privileges

The Main Menu gives you access to these Menu interface features:

- **Status and Counters:** Provides access to display screens showing switch information, port status and counters, port and VLAN address tables, and spanning tree information. (See Appendix B, “Monitoring and Analyzing Switch Operation”.)
- **Switch Configuration:** Provides access to configuration screens for displaying and changing the current configuration settings. (See the Contents listing at the front of this manual.) For a listing of features and parameters configurable through the menu interface, see the “Menu Features List” on page 3-14.
- **Console Passwords:** Provides access to the screen used to set or change Manager-level and Operator-level passwords, and to delete Manager and Operator password protection. (See the local password chapter in the Access Security Guide shipped with your switch.)
- **Event Log:** Enables you to read progress and error messages that are useful for checking and troubleshooting switch operation. (See “Using Logging To Identify Problem Sources” on page C-23.)

- **Command Line (CLI):** Selects the Command Line Interface at the same level (Manager or Operator) that you are accessing in the Menu interface. (See chapter 4, “Using the Command Line Interface (CLI)”.)
- **Reboot Switch:** Performs a “warm” reboot of the switch, which clears most temporary error conditions, resets the network activity counters to zero, and resets the system up-time to zero. A reboot is required to activate a change in the VLAN Support parameter. (See “Rebooting from the Menu Interface” on page 6-10.)
- **Download OS:** Enables you to download a new software version to the switch. (See Appendix A, “File Transfers”.)
- **Run Setup:** Displays the Switch Setup screen for quickly configuring basic switch parameters such as IP addressing, default gateway, logon default interface, spanning tree, and others. (See the *Installation and Getting Started* guide shipped with your switch.)
- **Stacking:** Enables you to use a single IP address and standard network cabling to manage a group of up to 16 switches in the same subnet (broadcast domain). See the chapter on stack management in the *Advanced Traffic Management Guide*.
- **Logout:** Closes the Menu interface and console session, and disconnects Telnet access to the switch. (See “How to End a Menu Session and Exit from the Console” on page 3-5.)

Screen Structure and Navigation

Menu interface screens include these three elements:

- Parameter fields and/or read-only information such as statistics
- Navigation and configuration actions, such as Save, Edit, and Cancel
- Help line to describe navigation options, individual parameters, and read-only data

For example, in the following System Information screen:

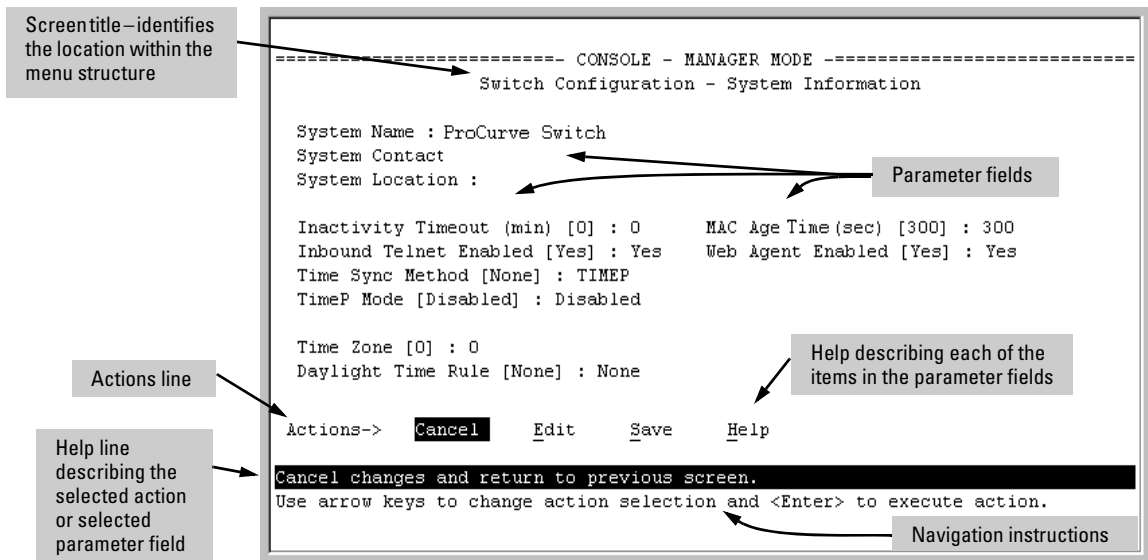

Figure 3-4. Elements of the Screen Structure

“Forms” Design. The configuration screens, in particular, operate similarly to a number of PC applications that use forms for data entry. When you first enter these screens, you see the current configuration for the item you have selected. To change the configuration, the basic operation is to:

1. Press **[E]** to select the **Edit** action.
2. Navigate through the screen making all the necessary configuration changes. (See table 3-1 on page 3-10.)
3. Press **[Enter]** to return to the **Actions** line. From there you can save the configuration changes or cancel the changes. Cancel returns the configuration to the values you saw when you first entered the screen.

Table 3-1. How To Navigate in the Menu Interface

Task:	Actions:
Execute an action from the “Actions →” list at the bottom of the screen:	<p>Use either of the following methods:</p> <ul style="list-style-type: none"> • Use the arrow keys (←) or (→) to highlight the action you want to execute, then press [Enter]. • Press the key corresponding to the capital letter in the action name. For example, in a configuration menu, press [E] to select Edit and begin editing parameter values.
Reconfigure (edit) a parameter setting or a field:	<ol style="list-style-type: none"> 1. Select a configuration item, such as System Name. (See figure 2-4.) 2. Press [E] (for Edit on the Actions line). 3. Use [Tab] or the arrow keys (←, →, ↑, or ↓) to highlight the item or field. 4. Do one of the following: <ul style="list-style-type: none"> – If the parameter has preconfigured values, either use the Space bar to select a new option or type the first part of your selection and the rest of the selection appears automatically. (The help line instructs you to “Select” a value.) – If there are no preconfigured values, type in a value (the Help line instructs you to “Enter” a value). 5. If you want to change another parameter value, return to step 3. 6. If you are finished editing parameters in the displayed screen, press [Enter] to return to the Actions line and do one of the following: <ul style="list-style-type: none"> – To save and activate configuration changes, press [S] (for the Save action). This saves the changes in the startup configuration and also implements the change in the currently running configuration. (See Chapter 6, “Switch Memory and Configuration”.) – To exit from the screen without saving any changes that you have made (or if you have not made changes), press [C] (for the Cancel action). <p>Note: In the menu interface, executing Save activates most parameter changes and saves them in the startup configuration (or flash) memory, and it is therefore not necessary to reboot the switch after making these changes. But if an asterisk appears next to any menu item you reconfigure, the switch will not activate or save the change for that item until you reboot the switch. In this case, rebooting should be done after you have made all desired changes and then returned to the Main Menu.</p> 7. When you finish editing parameters, return to the Main Menu. 8. If necessary, reboot the switch by highlighting Reboot Switch in the Main Menu and pressing [Enter]. (See the Note, above.)
Exit from a read-only screen.	Press [B] (for the B ack action).

To get Help on individual parameter descriptions. In most screens there is a **Help** option in the **Actions** line. Whenever any of the items in the **Actions** line is highlighted, press **[H]**, and a separate help screen is displayed. For example:

----- CONSOLE - MANAGER MODE -----
Switch Configuration - System Information

System Name : ProCurve Switch
System Contact
System Location :

Inactivity Timeout (min) [0] : 0 MAC Age Time (sec) [300] : 300
Inbound Telnet Enabled [Yes] : Yes Web Agent Enabled [Yes] : Yes
Time Sync Method [None] : TIMEP
TimeP Mode [Disabled] : Disabled

Time Zone [0] : 0
Daylight Time Rule [None] : None

Actions-> **Cancel** Edit Save Help

Cancel changes and return to previous screen.
Use arrow keys to change action selection and <Enter> to execute action.

Annotations:

- Highlight on any item in the Actions line indicates that the Actions line is active.
- The Help line provides a brief descriptor of the highlighted Action item or parameter.
- Pressing [H] or highlighting Help and pressing [Enter] displays Help for the parameters listed in the upper part of the screen

Figure 3-5. Example Showing How To Display Help

To get Help on the actions or data fields in each screen: Use the arrow keys (←, →, ↑, or ↓) to select an action or data field. The help line under the **Actions** items describes the currently selected action or data field.

For guidance on how to navigate in a screen: See the instructions provided at the bottom of the screen, or refer to “Screen Structure and Navigation” on page 3-9.

Rebooting the Switch

Rebooting the switch from the menu interface

- Terminates all current sessions and performs a reset of the operating system
- Activates any menu interface configuration changes that require a reboot
- Resets statistical counters to zero

(Note that statistical counters can be reset to zero without rebooting the switch.)

To Reboot the switch, use the **Reboot Switch** option in the Main Menu. (Note that the Reboot Switch option is not available if you log on in Operator mode; that is, if you enter an Operator password instead of a manager password at the password prompt.)

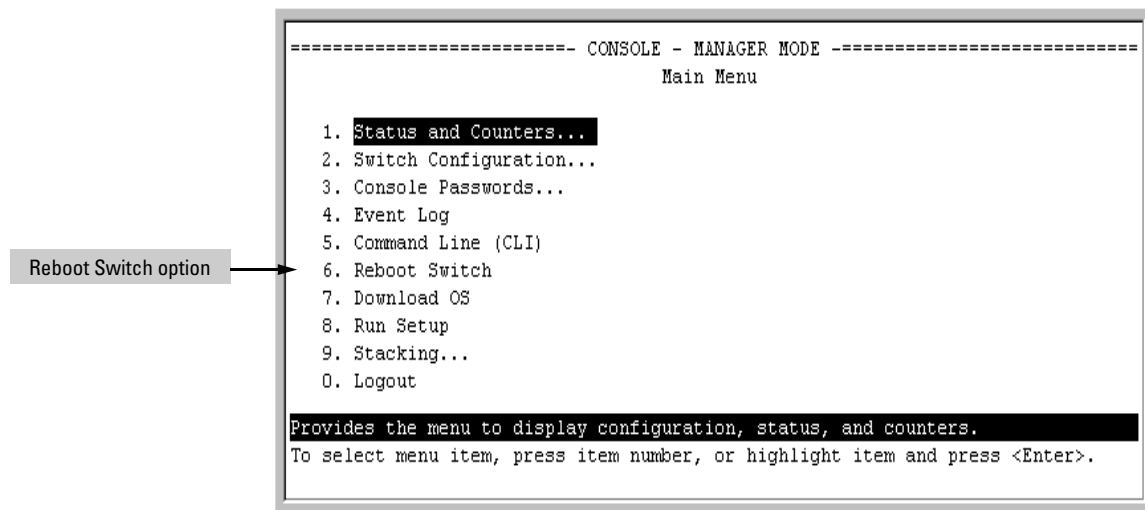

Figure 3-6. The Reboot Switch Option in the Main Menu

Rebooting To Activate Configuration Changes. Configuration changes for most parameters in the menu interface become effective as soon as you save them. However, you must reboot the switch in order to implement a change in the **Maximum VLANs to support parameter**. (To access this parameter, go to the Main Menu and select:

2. Switch Configuration

8. VLAN Menu

1. VLAN Support.)

If you make configuration changes in the menu interface that require a reboot, the switch displays an asterisk (*) next to the menu item in which the change has been made. For example, if you change and save the value for the **Maximum VLANs to support** parameter, an asterisk appears next to the **VLAN Support** entry in the VLAN Menu screen (below), and also next to the **Switch Configuration** entry in the Main Menu, as shown in figure 3-2 on page 3-6:

The screenshot shows the 'Switch Configuration Menu' in 'CONSOLE - MANAGER MODE'. The menu items are:

- 1. System Information
- 2. Port/Trunk Settings
- 3. Network Monitoring Port
- 4. Spanning Tree Operation
- 5. IP Configuration
- 6. SNMP Community Names
- 7. IP Authorized Managers
- *8. VLAN Menu...
- 0. Return to Main Menu...

Below the menu, a message reads: 'Displays the menu to activate and configure, or deactivate VLAN support. To select menu item, press item number, or highlight item and press <Enter>. (*Needs reboot to activate changes.)' The asterisk next to 'VLAN Menu...' and the note below it indicate that changes made here require a reboot.

Annotations on the left side of the image:

- A box with the text 'Asterisk indicates a configuration change that requires a reboot in order to take effect.' has an arrow pointing to the asterisk next to 'VLAN Menu...'.
- A box with the text 'Reminder to reboot the switch to activate configuration changes.' has an arrow pointing to the note below the menu: '(*Needs reboot to activate changes.)'.

Figure 3-7. Indication of a Configuration Change Requiring a Reboot

To activate changes indicated by the asterisk, go to the Main Menu and select the **Reboot Switch** option.

Note

Executing the **write memory** command in the CLI does not affect pending configuration changes indicated by an asterisk in the menu interface. That is, only a reboot from the menu interface or a **boot** or **reload** command from the CLI will activate a pending configuration change indicated by an asterisk.

Menu Features List

Status and Counters

- General System Information
- Switch Management Address Information
- Port Status
- Port Counters
- Address Table
- Port Address Table
- Spanning Tree Information

Switch Configuration

- System Information
- Port/Trunk Settings
- Network Monitoring Port
- Spanning Tree Operation
- IP Configuration
- SNMP Community Names
- IP authorized Managers
- VLAN Menu

Console Passwords

Event Log

Command Line (CLI)

Reboot Switch

Download OS

Run Setup

Stacking

- Stacking Status (This Switch)
- Stacking Status (All)
- Stack Configuration
- Stack Management (*Available in Stack Commander Only*)
- Stack Access (*Available in Stack Commander Only*)

Logout

Where To Go From Here

This chapter provides an overview of the menu interface and how to use it. The following table indicates where to turn for detailed information on how to use the individual features available through the menu interface.

Option:	Turn to:
To use the Run Setup option	Refer to the <i>Installation and Getting Started Guide</i> shipped with the switch.
To use the ProCurve Stack Manager	See the chapter on stack management in the <i>Advanced Traffic Management Guide</i> .
To view and monitor switch status and counters	Appendix B, "Monitoring and Analyzing Switch Operation"
To learn how to configure and use passwords and other security features	Refer to the <i>Access Security Guide</i> for your switch.
To learn how to use the Event Log	"Using Logging To Identify Problem Sources" on page C-23
To learn how the CLI operates	Chapter 4, "Using the Command Line Interface (CLI)"
To download software (the OS)	Appendix A, "File Transfers"
For a description of how switch memory handles configuration changes	"Switch Memory and Configuration" on page 6-1
For information on other switch features and how to configure them	See the Table of Contents at the front of this manual.

Using the Menu Interface
Where To Go From Here

Using the Command Line Interface (CLI)

Contents

Overview	4-2
Accessing the CLI	4-2
Using the CLI	4-2
Privilege Levels at Logon	4-3
Privilege Level Operation	4-4
Operator Privileges	4-4
Manager Privileges	4-5
How To Move Between Levels	4-7
Listing Commands and Command Options	4-8
Listing Commands Available at Any Privilege Level	4-8
Command Option Displays	4-10
Displaying CLI "Help"	4-11
Configuration Commands and the Context Configuration Modes ..	4-13
CLI Control and Editing	4-16

Overview

The CLI is a text-based command interface for configuring and monitoring the switch. The CLI gives you access to the switch's full set of commands while providing the same password protection that is used in the web browser interface and the menu interface.

Accessing the CLI

Like the menu interface, the CLI is accessed through the switch console, and, in the switch's factory default state, is the default interface when you start a console session. You can access the console out-of-band by directly connecting a terminal device to the switch, or in-band by using Telnet either from a terminal device or through the web browser interface.

Note

The serial port on the 2810 switch is an RJ45 port located in the lower left corner on the front panel of the switch.

Also, if you are using the menu interface, you can access the CLI by selecting the **Command Line (CLI)** option in the Main Menu.

Using the CLI

The CLI offers these privilege levels to help protect the switch from unauthorized access:

1. Operator
2. Manager
3. Global Configuration
4. Context Configuration

Note

CLI commands are not case-sensitive.

When you use the CLI to make a configuration change, the switch writes the change to the Running-Config file in volatile memory. This allows you to test your configuration changes before making them permanent. To make changes permanent, you must use the **write memory** command to save them to the Startup Config file in non-volatile memory. If you reboot the switch without first using **write memory**, all changes made since the last reboot or **write memory** (whichever is later) will be lost. For more on switch memory and saving configuration changes, see Chapter 6, “Switch Memory and Configuration”.

Privilege Levels at Logon

Privilege levels control the type of access to the CLI. To implement this control, you must set at least a Manager password. *Without a Manager password configured, anyone having serial port, Telnet, or web browser access to the switch can reach all CLI levels.* (For more on setting passwords, refer to the local manager and operator password chapter in the *Access Security Guide* for your switch.)

When you use the CLI to log on to the switch, and passwords are set, you will be prompted to enter a password. For example:



```
Copyright (C) 1991-2003 Hewlett-Packard Co. All Rights Reserved.  
  
RESTRICTED RIGHTS LEGEND  
  
Use, duplication, or disclosure by the Government is subject to restrictions  
as set forth in subdivision (b) (3) (ii) of the Rights in Technical Data and  
Computer Software clause at 52.227-7013.  
  
HEWLETT-PACKARD COMPANY, 3000 Hanover St., Palo Alto, CA 94303  
  
Password: _
```

An arrow points from a grey box labeled "Password Prompt" to the "Password: _" line.

Figure 4-1. Example of CLI Log-On Screen with Password(s) Set

In the above case, you will enter the CLI at the level corresponding to the password you provide (operator or manager).

If no passwords are set when you log onto the CLI, you will enter at the Manager level. For example:

```
ProCurve# _
```

Caution

*ProCurve strongly recommends that you configure a Manager password. If a Manager password is not configured, then the Manager level is not password-protected, and anyone having in-band or out-of-band access to the switch may be able to reach the Manager level and compromise switch and network security. Note that configuring only an Operator password *does not* prevent access to the Manager level by intruders who have the Operator password.*

Pressing the Clear button on the front of the switch removes password protection. *For this reason, it is recommended that you protect the switch from physical access by unauthorized persons.* If you are concerned about switch security and operation, you should install the switch in a secure location, such as a locked wiring closet.

Privilege Level Operation

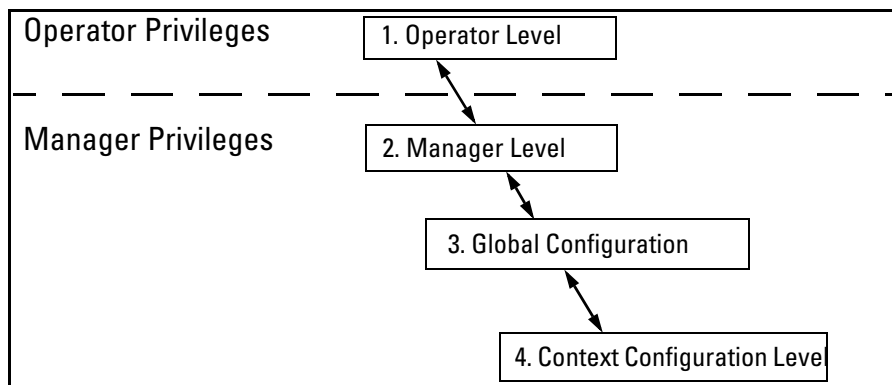

Figure 4-2. Access Sequence for Privilege Levels

Operator Privileges

At the Operator level you can examine the current configuration and move between interfaces without being able to change the configuration. A ">" character delimits the Operator-level prompt. For example:

```
ProCurve> _ Example of the Operator prompt.
```

When using **enable** to move to the Manager level, the switch prompts you for the Manager password if one has already been configured.

Manager Privileges

Manager privileges give you three additional levels of access: Manager, Global Configuration, and Context Configuration. (See figure 4-2.) A “#” character delimits any Manager prompt. For example:

```
ProCurve#_           Example of the Manager prompt.
```

- **Manager level:** Provides all Operator level privileges plus the ability to perform system-level actions that do not require saving changes to the system configuration file. The prompt for the Manager level contains only the system name and the “#” delimiter, as shown above. To select this level, enter the **enable** command at the Operator level prompt and enter the Manager password, when prompted. For example:

```
ProCurve> enable    Enter enable at the Operator prompt.  
ProCurve# _        The Manager prompt.
```

- **Global Configuration level:** Provides all Operator and Manager level privileges, and enables you to make configuration changes to any of the switch’s software features. The prompt for the Global Configuration level includes the system name and “(config)”. To select this level, enter the **config** command at the Manager prompt. For example:

```
ProCurve# _        Enter config at the Manager prompt.  
ProCurve(config)#_ The Global Config prompt.
```

- **Context Configuration level:** Provides all Operator and Manager privileges, and enables you to make configuration changes in a specific context, such as one or more ports or a VLAN. The prompt for the Context Configuration level includes the system name and the selected context. For example:

```
ProCurve(eth-1) #  
  
ProCurve(vlan-10) #
```

The Context level is useful, for example, if you want to execute several commands directed at the same port or VLAN, or if you want to shorten the command strings for a specific context area. To select this level, enter the specific context at the Global Configuration level prompt. For example, to select the context level for an existing VLAN with the VLAN ID of 10, you would enter the following command and see the indicated result:

```
ProCurve(config)# vlan 10  
  
ProCurve(vlan-10) #
```

Changing Interfaces. If you change from the CLI to the menu interface, or the reverse, you will remain at the same privilege level. For example, entering the menu command from the Operator level of the CLI takes you to the Operator privilege level in the menu interface.

Table 4-1. Privilege Level Hierarchy

Privilege Level	Example of Prompt and Permitted Operations		
Operator Privilege			
Operator Level	ProCurve>	show < command > setup	<i>View status and configuration information.</i>
		ping < argument > link-test < argument >	<i>Perform connectivity tests.</i>
		enable	<i>Move from the Operator level to the Manager level.</i>
		menu	<i>Move from the CLI interface to the menu interface.</i>
		logout	<i>Exit from the CLI interface and terminate the console session.</i>
		exit	<i>Terminate the current session (same as logout).</i>
Manager Privilege			
Manager Level	ProCurve#		<i>Perform system-level actions such as system control, monitoring, and diagnostic commands, plus any of the Operator-level commands. For a list of available commands, enter ? at the prompt.</i>
Global Configuration Level	ProCurve(config)#		<i>Execute configuration commands, plus all Operator and Manager commands. For a list of available commands, enter ? at the prompt.</i>
Context Configuration Level	ProCurve(eth-5)# ProCurve(vlan-100)#		<i>Execute context-specific configuration commands, such as a particular VLAN or switch port. This is useful for shortening the command strings you type, and for entering a series of commands for the same context. For a list of available commands, enter ? at the prompt.</i>

How To Move Between Levels

Change in Levels	Example of Prompt, Command, and Result
Operator level to Manager level	<pre>ProCurve> enable Password: _ ProCurve# _</pre> <p><i>After you enter enable, the Password prompt appears. After you enter the Manager password, the system prompt appears with the # symbol:</i></p>
Manager level to Global configuration level	<pre>ProCurve# config ProCurve(config)#</pre>
Global configuration level to a Context configuration level	<pre>ProCurve(config)# vlan 10 ProCurve(vlan-10)#</pre>
Context configuration level to another Context configuration level	<pre>ProCurve(vlan-10)# interface e 3 ProCurve(int-3)#</pre> <p><i>The CLI accepts "e" as the abbreviated form of "ethernet".</i></p>
Move from any level to the preceding level	<pre>ProCurve(int-3)# exit ProCurve(config)# exit ProCurve# exit ProCurve></pre>
Move from any level to the Manager level	<pre>ProCurve(int-3)# end ProCurve# —or— ProCurve(config)# end ProCurve#</pre>

Moving Between the CLI and the Menu Interface. When moving between interfaces, the switch retains the current privilege level (Manager or Operator). That is, if you are at the Operator level in the menu and select the **Command Line Interface (CLI)** option from the Main Menu, the CLI prompt appears at the Operator level.

Changing Parameter Settings. Regardless of which interface is used (CLI, menu interface, or web browser interface), the most recently configured version of a parameter setting overrides any earlier settings for that parameter.

For example, if you use the menu interface to configure an IP address of “X” for VLAN 1 and later use the CLI to configure a different IP address of “Y” for VLAN 1, then “Y” replaces “X” as the IP address for VLAN 1 in the running-config file. If you subsequently execute **write memory** in the CLI, then the switch also stores “Y” as the IP address for VLAN 1 in the startup-config file. (For more on the startup-config and running config files, see Chapter 6, “Switch Memory and Configuration”.)

Listing Commands and Command Options

At any privilege level you can:

- List all of the commands available at that level
- List the options for a specific command

Listing Commands Available at Any Privilege Level

At a given privilege level you can list and execute the commands that level offers, plus all of the commands available at preceding levels. For example, at the Operator level, you can list and execute only the Operator level commands. However, at the Manager level, you can list and execute the commands available at both the Operator and Manager levels.

Type “?” To List Available Commands. Typing the? symbol lists the commands you can execute at the current privilege level. For example, typing? at the Operator level produces this listing:

```
ProCurve > ?
  enable
  exit
  link-test
  logout
  menu
  ping
  show
  setup
ProCurve >
```

Figure 4-3. Example of the Operator Level Command Listing

Typing ? at the Manager level produces this listing:

```
ProCurve#

boot          Reboot the device.
clear         Clear table/statistics or authorized client public keys
configure    Enter the Configuration context.
copy         Copy datafiles to/from the switch.
end          Return to the Manager Exec context.
erase startup-c... Erase configuration file stored in flash.
getmib       Retrieve and display the value of the MIB objects
            specified.
kill         Kill all other active console, telnet, or ssh sessions.
log          Display log events.
page         Toggle paging mode.
print        Execute a command and redirect its output to the device
            channel for current session.
redo         Re-execute a command from history.
reload       Warm reboot of the switch.
repeat       Repeat execution of a previous command.
setmib       Set the value of a MIB object.
setup        Enter the 'Switch Setup' screen for basic switch
            configuration.
telnet       Initiate an outbound telnet session to another network
            device.

-- MORE --, next page: Space, next line: Enter, quit: Control-C
```



Figure 4-4. Example of the Manager-Level Command Listing

When **-- MORE --** appears, there are more commands in the listing. To list the next set of commands, press the Space bar. To list the remaining commands one-by-one, repeatedly press **[Enter]**.

Typing ? at the Global Configuration level or the Context Configuration level produces similar results. In a particular context level, the first block of command in the listing are the commands that are most relevant to the current context.

Use [Tab] To Search for or Complete a Command Word. You can use [Tab] to help you find CLI commands or to quickly complete the current word in a command. To do so, type one or more consecutive characters in a command and then press [Tab] (with no spaces allowed). For example, at the Global Configuration level, if you press [Tab] immediately after typing "t", the CLI displays the available command options that begin with "t". For example:

```
ProCurve(config)# t [Tab]
telnet-server
time
trunk
telnet
terminal
ProCurve(config)# t
```

As mentioned above, if you type part of a command word and press [Tab], the CLI completes the current word (if you have typed enough of the word for the CLI to distinguish it from other possibilities), including hyphenated extensions. For example:

```
ProCurve(config)# port [Tab]
ProCurve(config)# port-security _
```

Pressing [Tab] after a completed command word lists the further options for that command.

```
ProCurve(config)# stack [Tab]
commander <commander-str>
join <mac-addr>
auto-join
transmission-interval <integer>
<cr>
ProCurve(config)# stack
```

Command Option Displays

Conventions for Command Option Displays. When you use the CLI to list options for a particular command, you will see one or more of the following conventions to help you interpret the command data:

- Braces (<>) indicate a required choice.
- Square brackets ([]) indicate optional elements.
- Vertical bars (|) separate alternative, mutually exclusive options in a command.

Listing Command Options. You can use the CLI to remind you of the options available for a command by entering command keywords followed by **?**. For example, suppose you want to see the command options for configuring port C5:

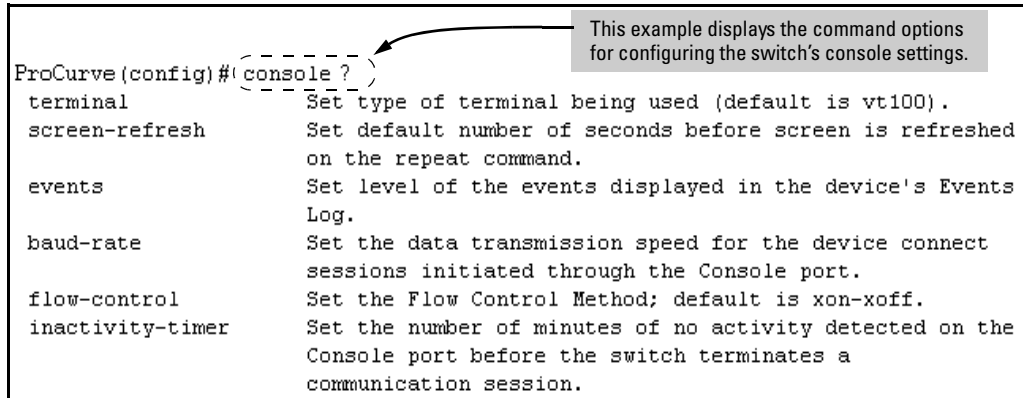

The screenshot shows a CLI session where the user enters 'console ?' at the prompt 'ProCurve (config) #'. The output lists several options: 'terminal', 'screen-refresh', 'events', 'baud-rate', 'flow-control', and 'inactivity-timer', each with a brief description. A callout box with an arrow pointing to the 'console ?' command contains the text: 'This example displays the command options for configuring the switch's console settings.'

```
ProCurve (config) # (console ?)
terminal          Set type of terminal being used (default is vt100).
screen-refresh    Set default number of seconds before screen is refreshed
                  on the repeat command.
events            Set level of the events displayed in the device's Events
                  Log.
baud-rate         Set the data transmission speed for the device connect
                  sessions initiated through the Console port.
flow-control      Set the Flow Control Method; default is xon-xoff.
inactivity-timer Set the number of minutes of no activity detected on the
                  Console port before the switch terminates a
                  communication session.
```

Figure 4-5. Example of How To List the Options for a Specific Command

Displaying CLI "Help"

CLI Help provides two types of context-sensitive information:

- Command list with a brief summary of each command's purpose
- Detailed information on how to use individual commands

Displaying Command-List Help. You can display a listing of command Help summaries for all commands available at the current privilege level. That is, when you are at the Operator level, you can display the Help summaries only for Operator-Level commands. At the Manager level, you can display the Help summaries for both the Operator and Manager levels, and so on.

Syntax: help

For example, to list the Operator-Level commands with their purposes:

```
ProCurve> help
enable          Enter Manager Exec level
exit            Return to previous command level or logout if at first
               level.
link-test       Test the connection to a MAC address on the LAN.
logout          Terminate this console/telnet session.
menu            Go to the menu system.
ping            Send IP Ping requests to a device on the network.
show            Display configuration data.
```

Figure 4-6. Example of Context-Sensitive Command-List Help

Displaying Help for an Individual Command. You can display Help for any command that is available at the current context level by entering enough of the command string to identify the command, along with help.

Syntax: < *command-string* > help

For example, to list the Help for the **interface** command in the Global Configuration privilege level:

```
ProCurve(config)# interface help
Usage: [no] interface [ethernet] PORT-LIST [...]

Description: Enter the Interface Configuration Level, or execute one
command for that level. Without optional parameters
specified, the 'interface' command changes the context to
the Interface Configuration Context Level for execution of
configuration changes to the port or ports in the PORT-LIST.
The 'interface [ethernet] PORT-LIST' can be followed by any
command from the Interface Configuration Context Level in the
same command line. In this case the context level is not
changed, but the command is also executed for the port or ports
in the PORT-LIST. Use 'interface [ethernet] PORT-LIST ?'
to get a list of all valid commands.
```

Figure 4-7. Example of How To Display Help for a Specific Command

A similar action lists the Help showing additional parameter options for a given command. The following example illustrates how to list the Help for an interface command acting on a specific port:

```

ProCurve(config)# interface e c5 help
flow-control      Enable/disable flow control on the port.
speed-duplex      Define mode of operation for the port.
bcast-limit       Set a broadcast traffic percentage limit.
unknown-vlans     Define what the port will do when it encounters GVRP
                  packet requesting it to join a VLAN.
enable            Enable port.
disable           Disable port.
lacp              Define whether LACP is enabled on the port, and whether it
                  is in active or passive mode when enabled.
monitor           Define that the port is to be monitored.

```

Figure 4-8. Example of Help for a Specific Instance of a Command

Note that trying to list the help for an individual command from a privilege level that does not include that command results in an error message. For example, trying to list the help for the **interface** command while at the global configuration level produces this result:

```

ProCurve# interface help
Invalid input: interface

```

Configuration Commands and the Context Configuration Modes

You can execute any configuration command in the global configuration mode or in selected context modes. However, using a context mode enables you to execute context-specific commands faster, with shorter command strings.

The configuration options include interface (port or trunk group) and VLAN context modes:

Port or Trunk-Group Context . Includes port- or trunk-specific commands that apply only to the selected port(s) or trunk group, plus the global configuration, Manager, and Operator commands. The prompt for this mode includes the identity of the selected port(s):

```

ProCurve(config)# interface e c3-c6 Command executed at
                                     configuration level for
ProCurve(config)# interface e trk1 entering port or trk1 static
                                     trunk-group context.

ProCurve(eth-C5-C8) # Resulting prompt showing
ProCurve(eth-Trk1) # port or static trunk
                                     contexts.

```

```
ProCurve(eth-C5-C8) #?
```

```
ProCurve(eth-C5-C8) #?
```

Lists the commands you can use in the port or static trunk context, plus the Manager, Operator, and context commands you can execute at this level.

The screenshot shows a CLI help menu for the command `ProCurve(eth-C3-C6) # ?`. The menu lists various commands and their descriptions. Annotations include an arrow pointing to the first block of commands (flow-control through monitor) and a text box stating: "In the port context, the first block of commands in the '?' listing show the context-specific commands that will affect only ports C3-C6." Another set of arrows points to the remaining commands (interface ether... through erase), with a text box stating: "The remaining commands in the listing are Manager, Operator, and context commands." The full listing is as follows:

```
ProCurve(eth-C3-C6) # ?

flow-control      Enable/disable flow control on the port.
speed-duplex      Define mode of operation for the port.
broadcast-limit   Set a broadcast traffic percentage limit.
unknown-vlans     Define what the port will do when it encounters GVRP
                  packet requesting it to join a VLAN.
enable            Enable port.
disable           Disable port.
lacp              Define whether LACP is enabled on the port, and whether
                  is in active or passive mode when enabled.
monitor           Define that the port is to be monitored.

interface ether... Enter the Interface Configuration Level, or execute one
                  command on that level.
vlan              Add, delete, edit VLAN configuration or enter a VLAN
                  context.

boot system flash Reboot the device.
configure         Enter the Configuration context.
copy              Copy datafiles to/from the switch.
end               Return to the Manager Exec context.
erase             Erase the configuration file stored in flash.
-- MORE --, next page: Space, next line: Enter, quit: Control-C
```

Figure 4-9. Context-Specific Commands Affecting Port Context

VLAN Context . Includes VLAN-specific commands that apply only to the selected VLAN, plus Manager and Operator commands. The prompt for this mode includes the VLAN ID of the selected VLAN. For example, if you had already configured a VLAN with an ID of 100 in the switch:

```
ProCurve(config)# vlan 100
```

Command executed at configuration level to enter VLAN 100 context.

```
ProCurve(vlan-100)#
```

Resulting prompt showing VLAN 100 context.

```
ProCurve(vlan-100)# ?
```

Lists commands you can use in the VLAN context, plus Manager, Operator, and context commands you can execute at this level.

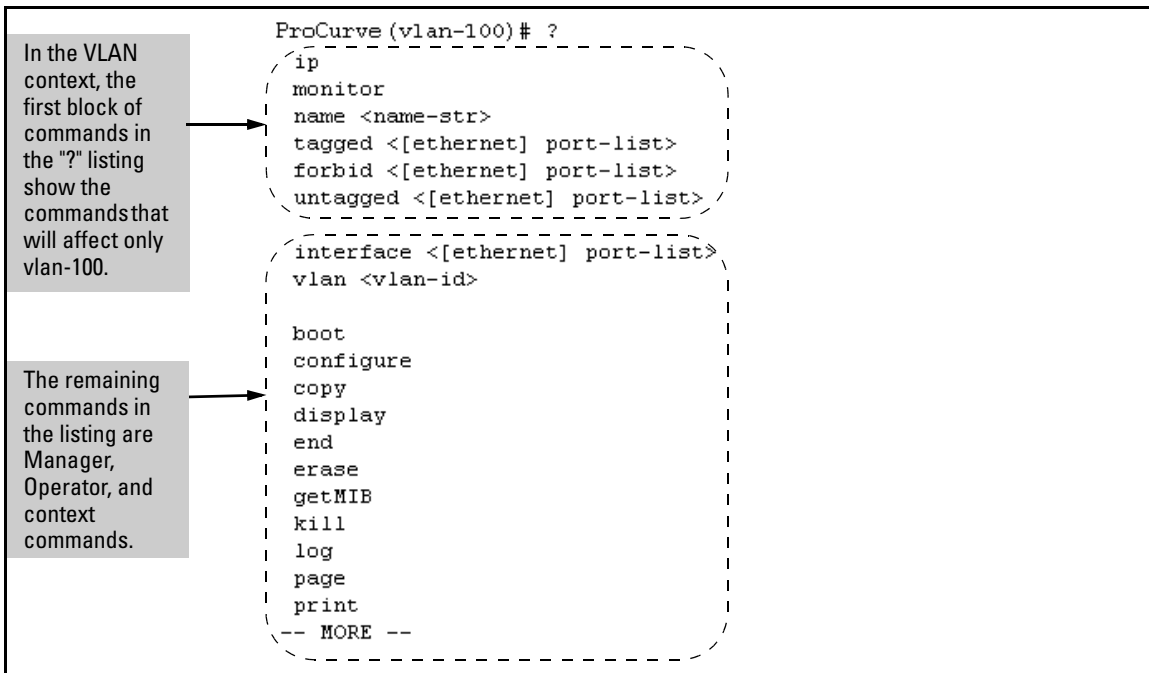





Figure 4-10. Context-Specific Commands Affecting VLAN Context

CLI Control and Editing

Keystrokes	Function
[Ctrl] [A]	Jumps to the first character of the command line.
[Ctrl] [B] or 	Moves the cursor back one character.
[Ctrl] [C]	Terminates a task and displays the command prompt.
[Ctrl] [D]	Deletes the character at the cursor.
[Ctrl] [E]	Jumps to the end of the current command line.
[Ctrl] [F] or 	Moves the cursor forward one character.
[Ctrl] [K]	Deletes from the cursor to the end of the command line.
[Ctrl] [L] or [Ctrl] [R]	Repeats current command line on a new line.
[Ctrl] [N] or 	Enters the next command line in the history buffer.
[Ctrl] [P] or 	Enters the previous command line in the history buffer.
[Ctrl] [U] or [Ctrl] [X]	Deletes from the cursor to the beginning of the command line.
[Ctrl] [W]	Deletes the last word typed.
[Esc] [B]	Moves the cursor backward one word.
[Esc] [D]	Deletes from the cursor to the end of the word.
[Esc] [F]	Moves the cursor forward one word.
[Delete] or [Backspace]	Deletes the first character to the left of the cursor in the command line.

Using the Web Browser Interface

Contents

Overview	5-2
General Features	5-3
Starting a Web Browser Interface Session with the Switch	5-4
Using a Standalone Web Browser in a PC or UNIX Workstation	5-4
Using ProCurve Manager (PCM) or ProCurve Manager Plus (PCM+) ..	5-5
Tasks for Your First Web Browser Interface Session	5-7
Viewing the “First Time Install” Window	5-7
Creating Usernames and Passwords in the Browser Interface	5-8
Using the Passwords	5-10
Using the User Names	5-10
If You Lose a Password	5-11
Online Help for the Web Browser Interface	5-11
Support/Mgmt URLs Feature	5-12
Support URL	5-13
Help and the Management Server URL	5-13
Using the PCM Server for Switch Web Help	5-15
Status Reporting Features	5-16
The Overview Window	5-16
The Port Utilization and Status Displays	5-17
Port Utilization	5-17
Port Status	5-19
The Alert Log	5-20
Sorting the Alert Log Entries	5-20
Alert Types and Detailed Views	5-21
The Status Bar	5-22
Setting Fault Detection Policy	5-23

Overview

The Web browser interface built into the switch lets you easily access the switch from a browser-based PC on your network. This lets you do the following:

- Optimize your network uptime by using the Alert Log and other diagnostic tools
- Make configuration changes to the switch
- Maintain security by configuring usernames and passwords

This chapter covers the following:

- General features (page 5-3).
- Starting a web browser interface session (page 5-4)
- Tasks for your first web browser interface session (page 5-7):
 - Creating usernames and passwords in the web browser interface (page 5-8)
 - Selecting the fault detection configuration for the Alert Log operation (page 5-23)
 - Getting access to online help for the web browser interface (page 5-11)
- Description of the web browser interface:
 - Overview window and tabs (page 5-16)
 - Port Utilization and Status displays (page 5-17)
 - Alert Log and Alert types (page 5-20)
 - Setting the Fault Detection Policy (page 5-23)

Note

If you want security beyond that achieved with user names and passwords, you can disable access to the web browser interface. This is done by either executing **no web-management** at the Command Prompt or changing the **Web Agent Enabled** parameter setting to **No** (page 7-3).

General Features

The switch includes these web browser interface features:

Switch Configuration:

- Ports
- VLANs and Primary VLAN
- Fault detection
- Port monitoring (mirroring)
- System information
- Enable/Disable Multicast Filtering (IGMP) and Spanning Tree
- IP
- Stacking
- Support and management URLs

Switch Security: Usernames and passwords

Switch Diagnostics:

- Ping/Link Test
- Device reset
- Configuration report

Switch status

- Port utilization
- Port counters
- Port status
- Alert log

Switch system information listing

Starting a Web Browser Interface Session with the Switch

You can start a web browser session in the following ways:

- Using a standalone web browser on a network connection from a PC or UNIX workstation:
 - Directly connected to your network
 - Connected through remote access to your network
- Using a management station running ProCurve Manager on your network

Using a Standalone Web Browser in a PC or UNIX Workstation

This procedure assumes that you are using a compatible web browser (see the software *Release Notes* for more information) and that the switch is configured with an IP address accessible from your PC or workstation. (For more on assigning an IP address, refer to “IP Configuration” on page 8-3.)

1. Ensure that the Java™ applets are enabled for your browser. For more information on this topic, refer to your browser’s online Help.
2. Use the web browser to access the switch. If your network includes a Domain Name Server (DNS), your switch’s IP address may have a name associated with it (for example, **switch5308**) that you can type in the **Location or Address** field instead of the IP address. Using DNS names typically improves browser performance. Contact your network administrator to enquire about DNS names associated with your ProCurve switch.

Type the IP address (or DNS name) of the switch in the browser **Location** or **Address** (URL) field and press **[Enter]**. (It is not necessary to include **http://**.)

switch5308 **[Enter]** (example of a DNS-type name)

10.11.12.195 **[Enter]** (example of an IP address)

Using ProCurve Manager (PCM) or ProCurve Manager Plus (PCM+)

ProCurve Manager and ProCurve Manager Plus are designed for installation on a network management workstation. For this reason, the system requirements are different from the system requirements for accessing the switch's web browser interface from a non-management PC or workstation. For ProCurve PCM and PCM+ requirements, refer to the information provided with the software.

This procedure assumes that:

- You have installed the recommended web browser on a PC or workstation that serves as your network management station.
- The networked device you want to access has been assigned an IP address and (optionally) a DNS name, and has been discovered by PCM or PCM+. (For more on assigning an IP address, refer to "IP Configuration" on page 8-3.)

To establish a web browser session with ProCurve PCM or PCM+ running, do the following on the network management station:

1. Make sure the Java™ applets are enabled for your web browser. If they are not, refer to the web browser online Help for specific information on enabling the Java applets.
2. In the **Interconnected Devices** listing under **Network Manager Home** (in the PCM/PCM+ sidebar), right-click on the model number of the device you want to access.
3. The web browser interface automatically starts with the Status Overview window displayed for the selected device, as shown in figure 5-1.

Note

If the Registration window appears, click on the **Status** tab.

Using the Web Browser Interface

Starting a Web Browser Interface Session with the Switch

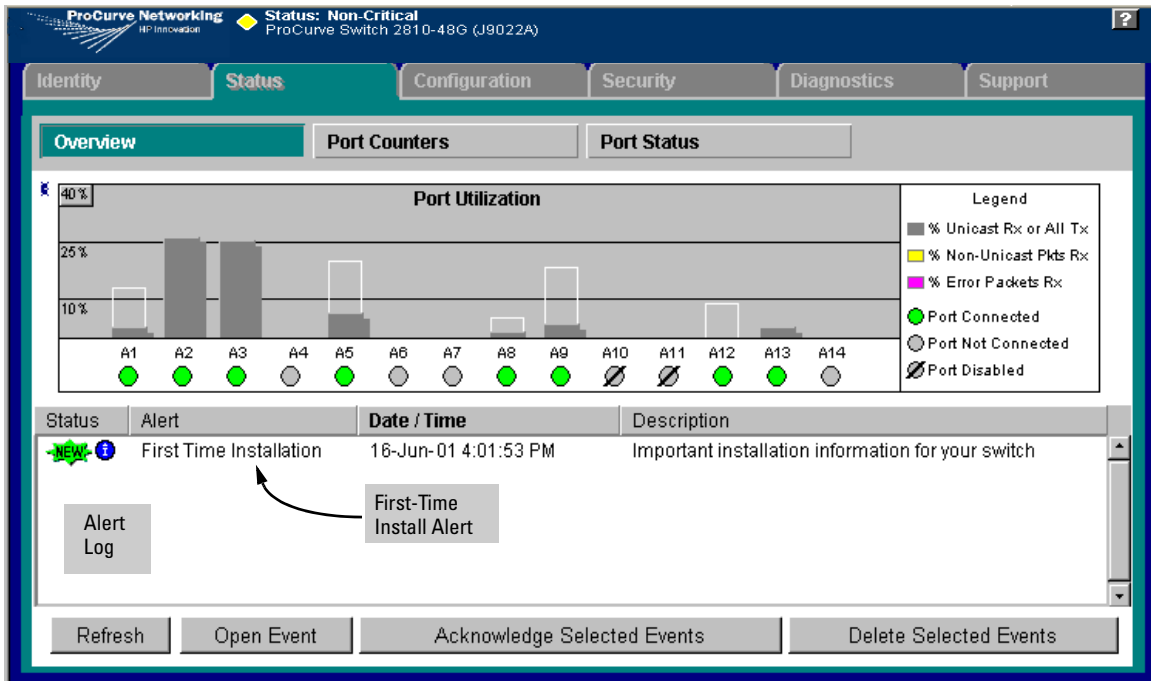

Figure 5-1. Example of Status Overview Screen

Note

The above screen appears somewhat different if the switch is configured as a stack Commander. For an example, see figure 2-3 on page 2-5.

Tasks for Your First Web Browser Interface Session

The first time you access the web browser interface, there are three tasks that you should perform:

- Review the “First Time Install” window
- Set Manager and Operator passwords
- Set access to the web browser interface online help

Viewing the “First Time Install” Window

When you access the switch’s web browser interface for the first time, the Alert log contains a “First Time Install” alert, as shown in figure 5-2. This gives you information about first time installations, and provides an immediate opportunity to set passwords for security and to specify a Fault Detection policy, which determines the types of messages that will be displayed in the Alert Log.

Double click on **First Time Install** in the Alert log (figure 5-1 on page 5-6). The web browser interface then displays the “First Time Install” window, below.

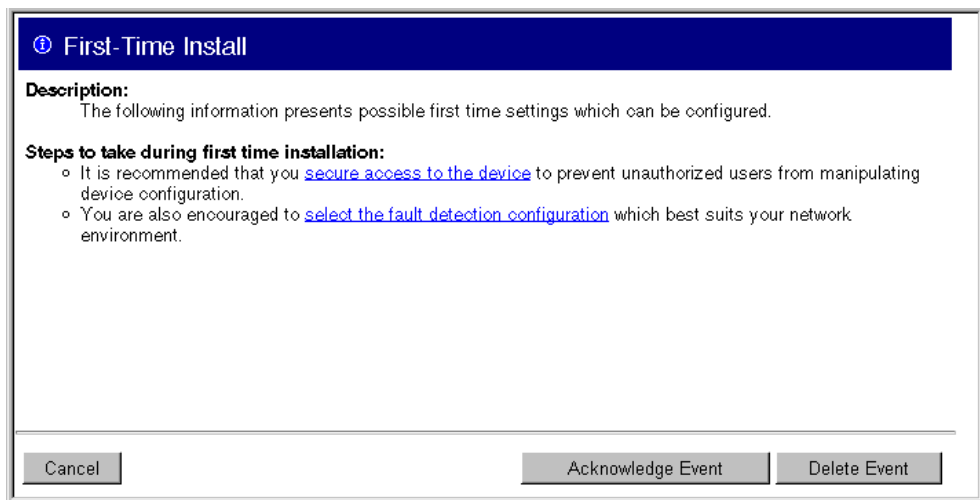

Figure 5-2. First-Time Install Window

This window is the launching point for the basic configuration you need to perform to set web browser interface passwords to maintain security and Fault Detection policy, which determines the types of messages that will be displayed in the Alert Log.

To set web browser interface passwords, click on **secure access to the device** to display the Device Passwords screen, and then go to the next page. (You can also access the password screen by clicking on the **Security** tab.)

To set Fault Detection policy, click on **select the fault detection configuration** in the second bullet in the window and go to the section, “Setting Fault Detection Policy” on page 5-23. (You can also access the password screen by clicking on the **Configuration** tab, and then [**Fault Detection**] button.)

Creating Usernames and Passwords in the Browser Interface

You may want to create both a username and password to create access security for your switch. There are two levels of access to the interface that can be controlled by setting user names and passwords:

- **Operator.** An Operator-level user name and password allows read-only access to most of the web browser interface, but prevents access to the Security window.
- **Manager.** A Manager-level user name and password allows full read/write access to the web browser interface.

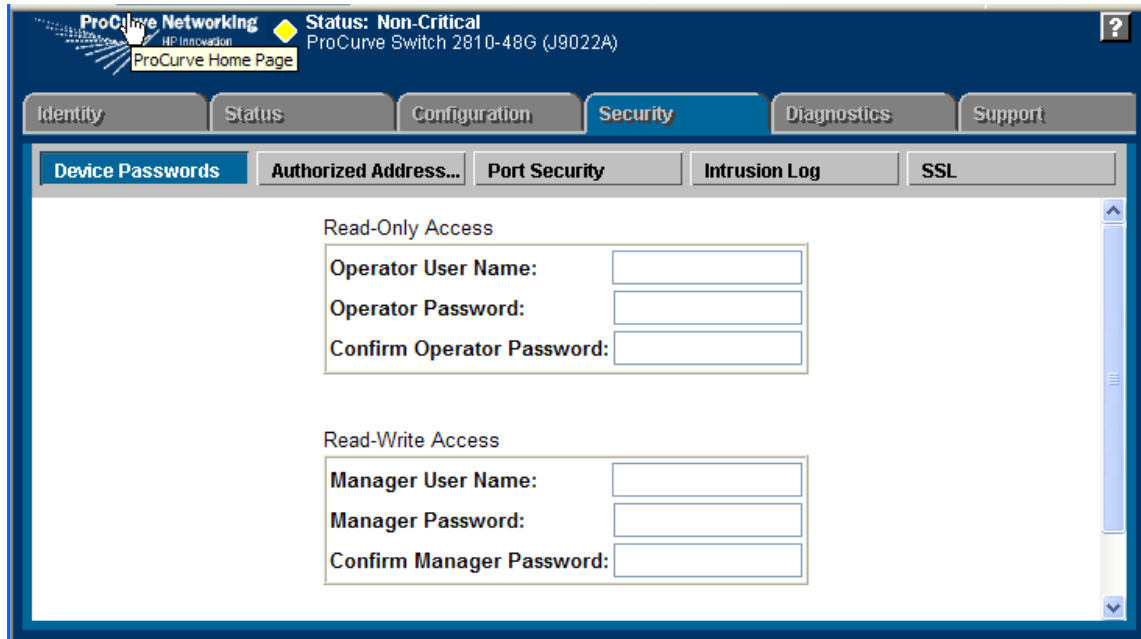

Figure 5-3. The Device Passwords Window

To set the passwords:

1. Access the Device Passwords screen by one of the following methods:
 - If the Alert Log includes a “First Time Install” event entry, double click on this event, then, in the resulting display, click on the **secure access to the device** link.
 - Select the **Security** tab.
2. Click in the appropriate box in the Device Passwords window and enter user names and passwords. You will be required to repeat the password strings in the confirmation boxes.

Both the user names and passwords can be up to 16 printable ASCII characters.

3. Click on **[Apply Changes]** to activate the user names and passwords.

Note

Passwords you assign in the web browser interface will overwrite previous passwords assigned in either the web browser interface, the Command Prompt, or the switch console. That is, the most recently assigned passwords are the switch's passwords, regardless of which interface was used to assign the string.

Using the Passwords

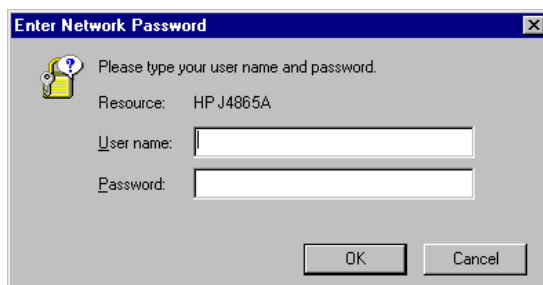

Figure 5-4. Example of the Password Window in the Web Browser Interface

The manager and operator passwords are used to control access to all switch interfaces. Once set, you will be prompted to supply the password every time you try to access the switch through any of its interfaces. The password you enter determines the capability you have during that session:

- Entering the manager password gives you full read/write capabilities
- Entering the operator password gives you read and limited write capabilities.

Using the User Names

If you also set user names in the web browser interface screen, you must supply the correct user name for web browser interface access. If a user name has not been set, then leave the User Name field in the password window blank.

Note that the Command Prompt and switch console interfaces use only the password, and do not prompt you for the User Name.

If You Lose a Password

If you lose the passwords, you can clear them by pressing the Clear button on the front of the switch. *This action deletes all password and user name protection from all of the switch's interfaces.*

The Clear button is provided for your convenience, but its presence means that if you are concerned with the security of the switch configuration and operation, you should make sure the switch is installed in a secure location, such as a locked wiring closet. (For more information, refer to “Front Panel Security” in the chapter titled “Configuring Username and Password Security” in the Access Security Guide for your switch.)

Online Help for the Web Browser Interface

Online Help is available for the web browser interface. You can use it by clicking on the question mark button in the upper right corner of any of the web browser interface screens.

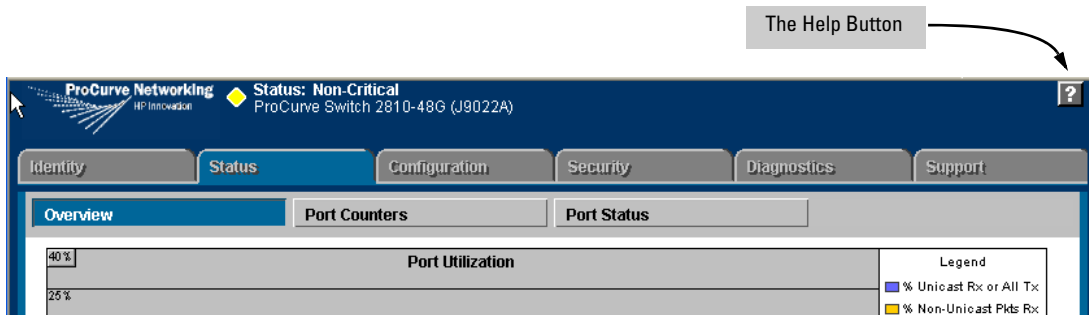

Figure 5-5. The Help Button

Context-sensitive help is provided for the screen you are on.

Note

To access the online Help for the web browser interface, you need either ProCurve Manager (version 1.5 or greater) installed on your network or an active connection to the World Wide Web. Otherwise, Online help for the web browser interface will not be available.

For more on Help access and operation, refer to “Help and the Management Server URL” on page 5-13.

Support/Mgmt URLs Feature

The Support/Mgmt URLs window enables you to change the World Wide Web Universal Resource Locator (URL) for two functions:

- **Support URL** – a support information site for your switch
- **Management Server URL** – The web site for web browser online Help.

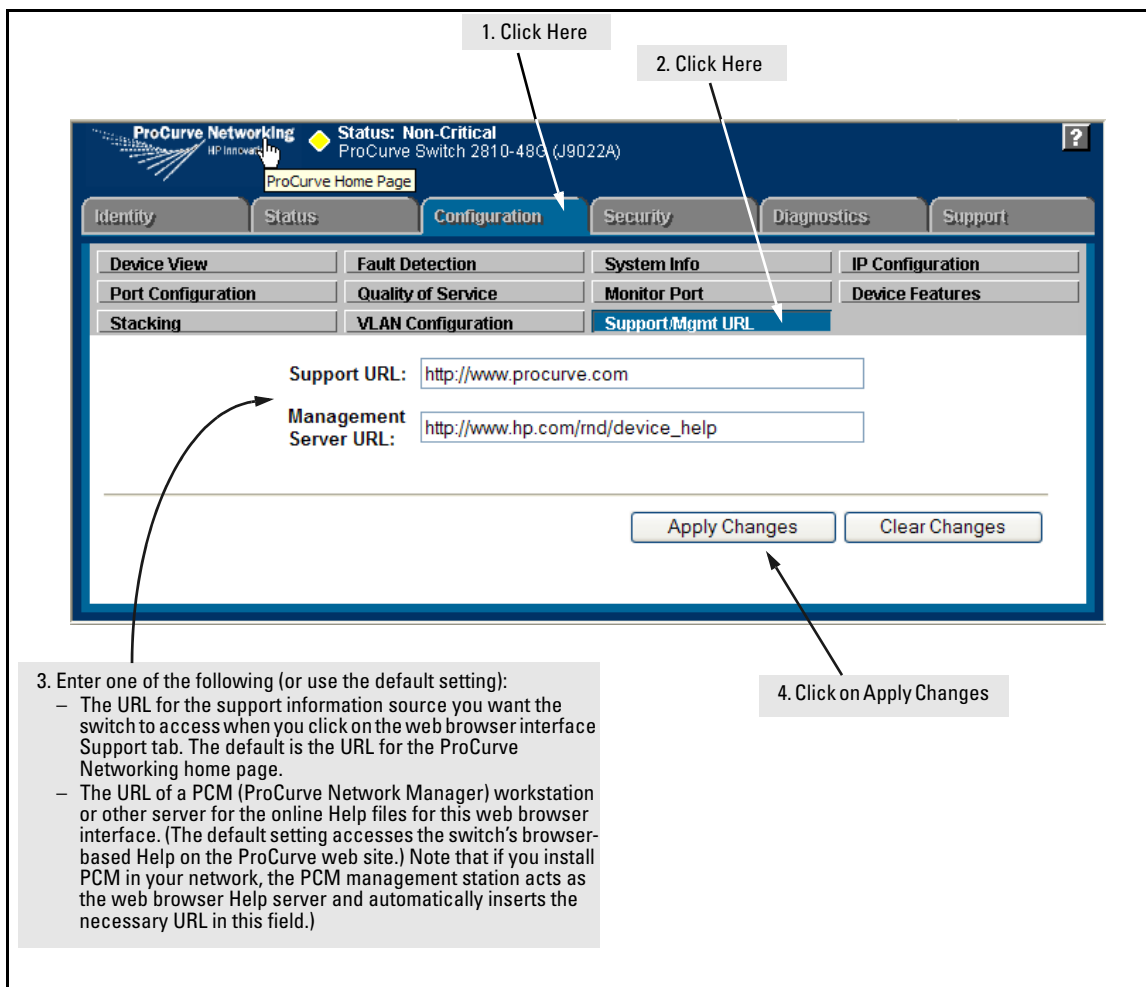

Figure 5-6. The Default Support/Mgmt URLs Window

Support URL

This is the site that the switch accesses when you click on the **Support** tab on the web browser interface. The default URL is:

<http://www.procurve.com>

which is the web site for ProCurve's networking products.

Click on the **[Support]** button on that page and you can get to support information regarding your switch, including white papers, operating system (OS) updates, and more.

You could instead enter the URL for a local site that you use for entering reports about network performance, or whatever other function you would like to be able to easily access by clicking on the **[Support]** tab.

Help and the Management Server URL

The **Management Server URL** field specifies the URL the switch uses to find online Help for the web browser interface.

- If you install PCM (ProCurve Manager) in your network, the PCM management station acts as the web browser Help server for the switch and automatically inserts the necessary URL in this field. (For more information on this option, refer to "Using the PCM Server for Switch Web Help on page 5-15.)
- In the default configuration (and if PCM is not running on your network) this field is set to the URL for accessing online Help from the ProCurve Networking Website:

<http://www.procurve.com>

Using this option, the Help files are automatically available if your workstation can access the World Wide Web. In this case, if Online Help fails to operate, ensure that the above URL appears in the **Management Server URL** field shown in figure 5-7:

Using the Web Browser Interface Support/Mgmt URLs Feature

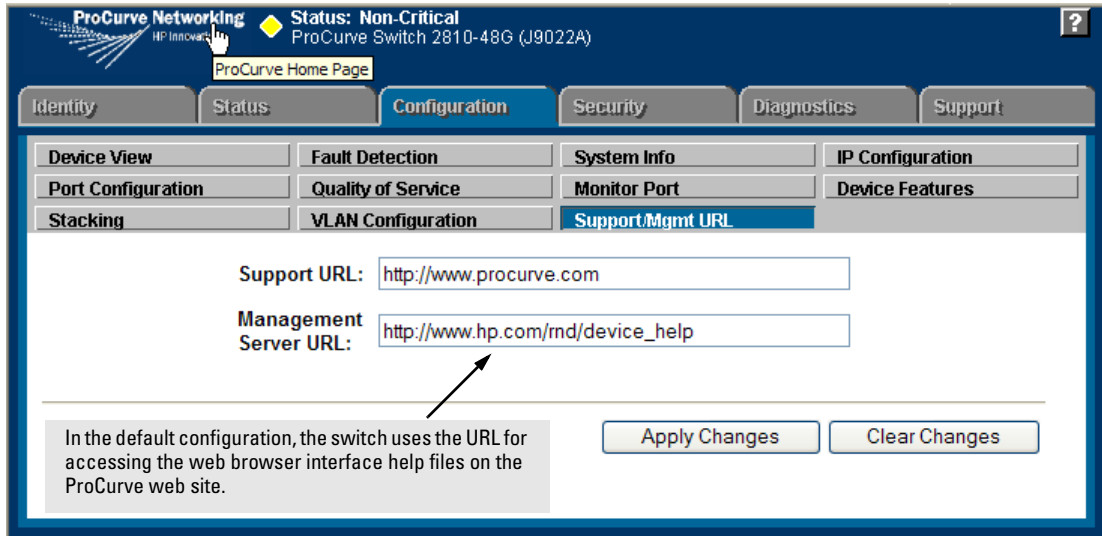

Figure 5-7. How To Access Web Browser Interface Online Help

Using the PCM Server for Switch Web Help

For ProCurve devices that support the “Web Help” feature, you can use the PCM server to host the switch help files for devices that do not have HTTP access to the ProCurve Support Web site.

1. Go to the ProCurve Support web site to get the Device Help files:

http://www.hp.com//rnd/device_help/

2. Copy the Web help files to the PCM server, under:

C:\program files\hewlett-packard\pnm\server\webroot\
rnd\sevice_help\help\hpwnd\webhelp

3. Add an entry, or edit the existing entry in the Discovery portion of the global properties (globalprops.prp) in PCM to redirect the switches to the help files on the PCM server. For example:

```
Global {  
  TempDir=data/temp  
  ...  
  Discovery{  
    ...  
    ...  
    DeviceHelpUrlRedirect=http://15.29.37.12.8040/rnd/device\_help  
    ...  
  }  
}
```

You will enter the IP address for your PCM server. 8040 is the standard port number to use.

4. Restart the Discovery process for the change to be applied.

Note

Changing the Discovery’s Global properties file will redirect the Device Help URL for all devices.

If you just want to change the Device Help URL for a particular device, then go to the Configuration tab on the Web UI for that device and select the “Support/Mgmt URL” button. Edit the entry in the “Management Server URL” field for the device to point to the PCM server; for example:

http://15.29.37.12.8040/rnd/device_help

Status Reporting Features

Browser elements covered in this section include:

- The Overview window (below)
- Port utilization and status (page 5-17)
- The Alert log (page 5-20)
- The Status bar (page 5-22)

The Overview Window

The Overview Window is the home screen for any entry into the web browser interface. The following figure identifies the various parts of the screen.

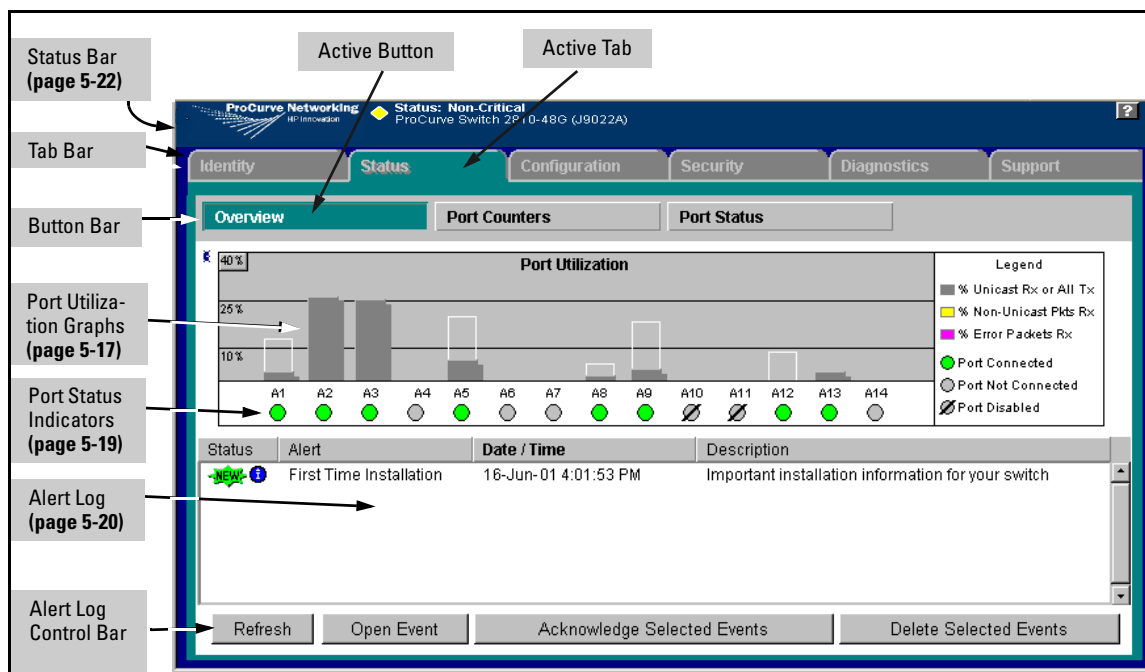

Figure 5-8. The Status Overview Window

Policy Management and Configuration. ProCurve PCM can perform network-wide policy management and configuration of your switch. The Management Server URL field (page 5-13) shows the URL for the management station performing that function. For more information, refer to the documentation provided with the PCM software.

The Port Utilization and Status Displays

The Port Utilization and Status displays show an overview of the status of the switch and the amount of network activity on each port. The following figure shows a sample reading of the Port Utilization and Port Status.

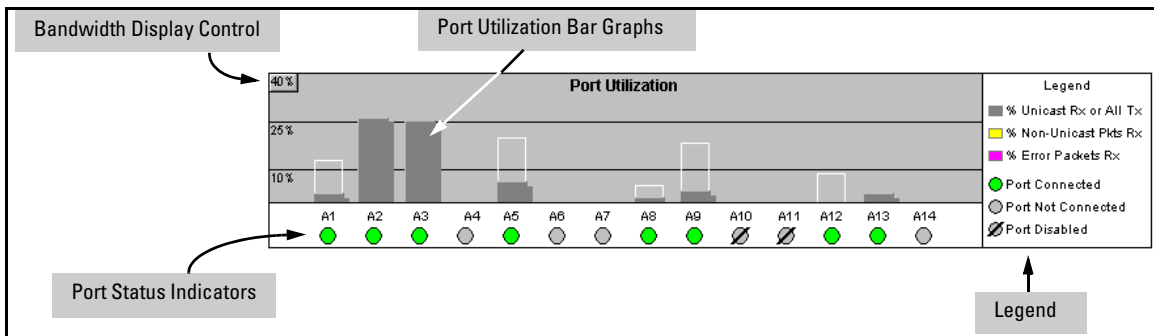

Figure 5-9. The Graphs Area

Port Utilization

The Port Utilization bar graphs show the network traffic on the port with a breakdown of the packet types that have been detected (unicast packets, non-unicast packets, and error packets). The Legend identifies traffic types and their associated colors on the bar graph:

- **% Unicast Rx & All Tx:** This is all unicast traffic received and all transmitted traffic of any type. This indicator (a blue color on many systems) can signify either transmitted or received traffic.
- **% Non-Unicast Pkts Rx:** All multicast and broadcast traffic received by the port. This indicator (a gold color on many systems) enables you to know “at-a-glance” the source of any non-unicast traffic that is causing high utilization of the switch. For example, if one port is receiving heavy broadcast or multicast traffic, all ports will become highly utilized. By color-coding the received broadcast and multicast utilization, the bar graph quickly and easily identifies the offending port. This makes it faster and easier to discover the exact source of the heavy traffic because you don’t have to examine port counter data from several ports.

- **% Error Pkts Rx:** All error packets received by the port. (This indicator is a reddish color on many systems.) Although errors received on a port are not propagated to the rest of the network, a consistently high number of errors on a specific port may indicate a problem on the device or network segment connected to the indicated port.
- **Maximum Activity Indicator:** As the bars in the graph area change height to reflect the level of network activity on the corresponding port, they leave an outline to identify the maximum activity level that has been observed on the port.

Utilization Guideline. A network utilization of 40% is considered the maximum that a typical Ethernet-type network can experience before encountering performance difficulties. If you observe utilization that is consistently higher than 40% on any port, click on the Port Counters button to get a detailed set of counters for the port.

To change the amount of bandwidth the Port Utilization bar graph shows. Click on the bandwidth display control button in the upper left corner of the graph. (The button shows the current scale setting, such as 40%.) In the resulting menu, select the bandwidth scale you want the graph to show (3%, 10%, 25%, 40%, 75%, or 100%), as shown in figure figure 5-10.

Note that when viewing activity on a gigabit port, you may want to select a lower value (such as 3% or 10%). This is because the bandwidth utilization of current network applications on gigabit links is typically minimal, and may not appear on the graph if the scale is set to show high bandwidth utilization.

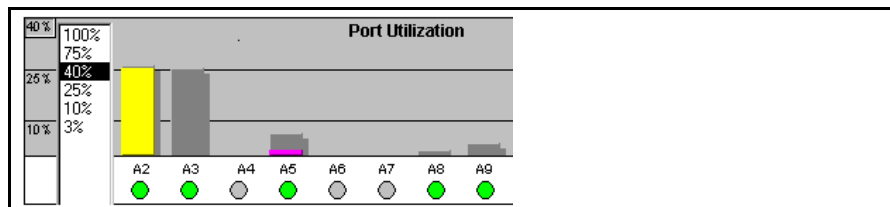

Figure 5-10. Changing the Graph Area Scale

To display values for each graph bar. Hold the mouse cursor over any of the bars in the graph, and a pop-up display is activated showing the port identification and numerical values for each of the sections of the bar, as shown in figure 5-11 (next).

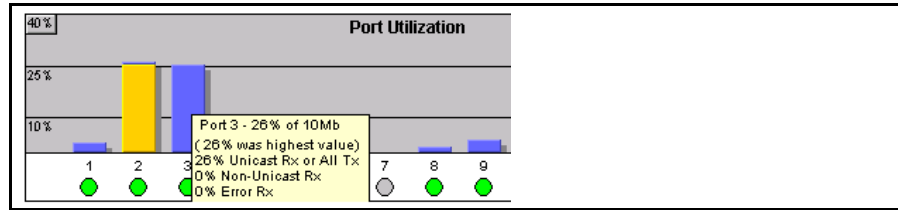

Figure 5-11. Display of Numerical Values for the Bar

Port Status

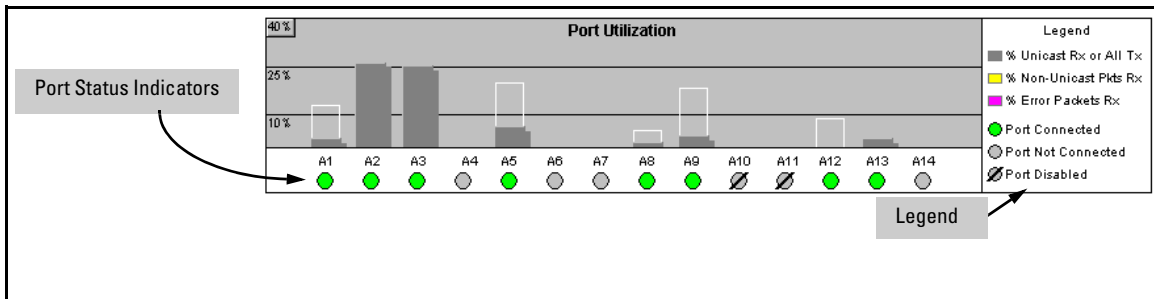

Figure 5-12. The Port Status Indicators and Legend



The Port Status indicators show a symbol for each port that indicates the general status of the port. There are four possible statuses:

- **Port Connected** – the port is enabled and is properly connected to an active network device.
- **Port Not Connected** – the port is enabled but is not connected to an active network device. A cable may not be connected to the port, or the device at the other end may be powered off or inoperable, or the cable or connected device could be faulty.
- **Port Disabled** – the port has been configured as disabled through the web browser interface, the switch console, or SNMP network management.
- **Port Fault-Disabled** – a fault condition has occurred on the port that has caused it to be auto-disabled. Note that the Port Fault-Disabled symbol will be displayed in the legend only if one or more of the ports is in that status. See appendix B, “Monitoring and Analyzing Switch Operation” for more information.

The Alert Log

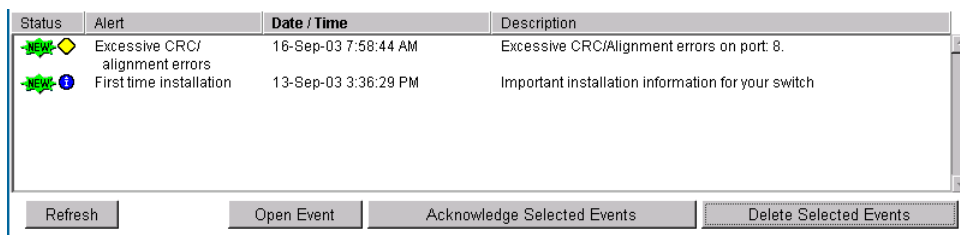
The web browser interface Alert Log, shown in the lower half of the screen, shows a list of network occurrences, or *alerts*, that were detected by the switch. Typical alerts are **Broadcast Storm**, indicating an excessive number of broadcasts received on a port, and **Problem Cable**, indicating a faulty cable. For more information on alerts, see “Alert Types and Detailed Views” on page 5-21



Status	Alert	Date / Time	Description
	Excessive CRC/alignment errors	16-Sep-03 7:58:44 AM	Excessive CRC/Alignment errors on port: 8.
	First time installation	13-Sep-03 3:36:29 PM	Important installation information for your switch

Refresh Open Event Acknowledge Selected Events Delete Selected Events

Figure 5-13. Example of the Alert Log

Each alert has the following fields of information:

- **Status** – The level of severity of the event generated. Severity levels can be Information, Normal, Warning, and Critical. If the alert is new (has not yet been acknowledged), the New symbol is also in the Status column.
- **Alert** – The specific event identification.
- **Date/Time** – The date and time the event was received by the web browser interface. This value is shown in the format: **DD-MM-YY HH:MM:SS AM/PM**, for example, **16-Sep-99 7:58:44 AM**.
- **Description** – A short narrative statement that describes the event. For example, **Excessive CRC/Alignment errors on port: 8**.

Sorting the Alert Log Entries

The alerts are sorted, by default, by the Date/Time field with the most recent alert listed at the top of the list. The second most recent alert is displayed below the top alert and so on. If alerts occurred at the same time, the simultaneous alerts are sorted by order in which they appear in the MIB.

The alert field that is being used to sort the alert log is indicated by which column heading is in bold. You can sort by any of the other columns by clicking on the column heading. The Alert and Description columns are sorted alphabetically, while the Status column is sorted by severity type, with more critical severity indicators appearing above less critical indicators.

Alert Types and Detailed Views

As of April, 2004, the web browser interface generates the following alert types:

- Auto Partition
- Backup Transition
- Excessive broadcasts
- Excessive CRC/alignment errors
- Excessive jabbering
- Excessive late collisions
- First Time Install
- Full-Duplex Mismatch
- Half-Duplex Mismatch
- High collision or drop rate
- Loss of Link
- Mis-Configured SQE
- Network Loop
- Polarity Reversal
- Security Violation
- Stuck 10BaseT Port
- Too many undersized (runt)/giant packets
- Transceiver Hot Swap

Note

When troubleshooting the sources of alerts, it may be helpful to check the switch's Port Status and Port Counter windows and the Event Log in the console interface.

By double clicking on Alert Entries, the web browser interface displays a Detail View or separate window detailing information about the events. The Detail View contains a description of the problem and a possible solution. It also provides four management buttons:

- **Acknowledge Event** – removes the New symbol from the log entry
- **Delete Event** – removes the alert from the Alert Log
- **Cancel Button** – closes the detail view with no change to the status of the alert and returns you to the Overview screen.

A sample Detail View describing an Excessive CRC/Alignment Error alert is shown here.

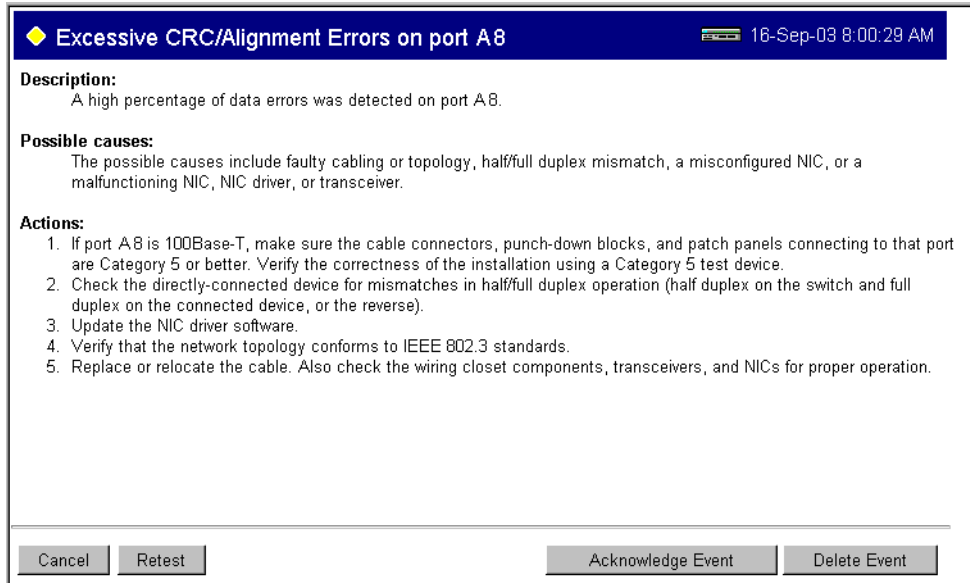

◆ Excessive CRC/Alignment Errors on port A8 16-Sep-03 8:00:29 AM

Description:
A high percentage of data errors was detected on port A8.

Possible causes:
The possible causes include faulty cabling or topology, half/full duplex mismatch, a misconfigured NIC, or a malfunctioning NIC, NIC driver, or transceiver.

Actions:

1. If port A8 is 100Base-T, make sure the cable connectors, punch-down blocks, and patch panels connecting to that port are Category 5 or better. Verify the correctness of the installation using a Category 5 test device.
2. Check the directly-connected device for mismatches in half/full duplex operation (half duplex on the switch and full duplex on the connected device, or the reverse).
3. Update the NIC driver software.
4. Verify that the network topology conforms to IEEE 802.3 standards.
5. Replace or relocate the cable. Also check the wiring closet components, transceivers, and NICs for proper operation.

Cancel Retest Acknowledge Event Delete Event

Figure 5-14. Example of Alert Log Detail View

The Status Bar

The Status Bar is displayed in the upper left corner of the web browser interface screen. Figure 5-15 shows an expanded view of the status bar.

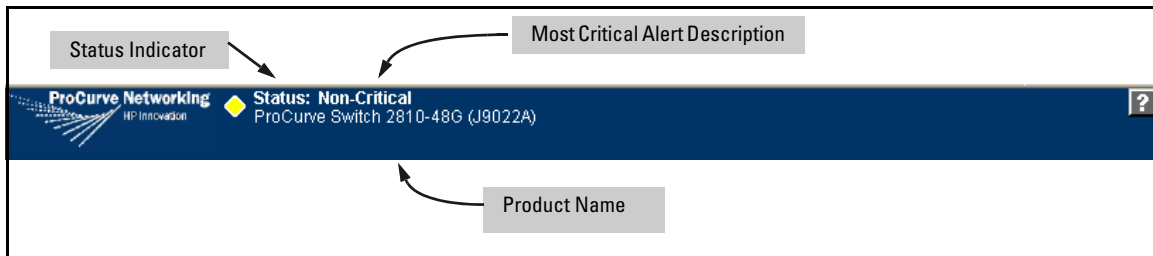

Labels pointing to components of the status bar:

- Status Indicator
- Most Critical Alert Description
- Product Name

ProCurve Networking HP Innovation

◆ Status: Non-Critical
ProCurve Switch 2810-48G (J9022A)





?

Figure 5-15. Example of the Status Bar

The Status bar consists of four objects:

- **Status Indicator.** Indicates, by icon, the severity of the most critical alert in the current display of the Alert Log. This indicator can be one of three shapes and colors as shown in the following table.

Table 5-1. Status Indicator Key

Color	Switch Status	Status Indicator Shape
Blue	Normal Activity; "First time installation" information available in the Alert log.	
Green	Normal Activity	
Yellow	Warning	
Red	Critical	

- **System Name.** The name you have configured for the switch by using Identity screen, **system name** command, or the switch console **System Information** screen.
- **Most Critical Alert Description.** A brief description of the earliest, unacknowledged alert with the current highest severity in the Alert Log, appearing in the right portion of the Status Bar. In instances where multiple critical alerts have the same severity level, only the earliest unacknowledged alert is deployed in the Status bar.
- **Product Name.** The product name of the switch to which you are connected in the current web browser interface session.

Setting Fault Detection Policy

One of the powerful features in the web browser interface is the Fault Detection facility. For your switch, this feature controls the types of alerts reported to the Alert Log based on their level of severity.

Set this policy in the Fault Detection window (figure 5-16).

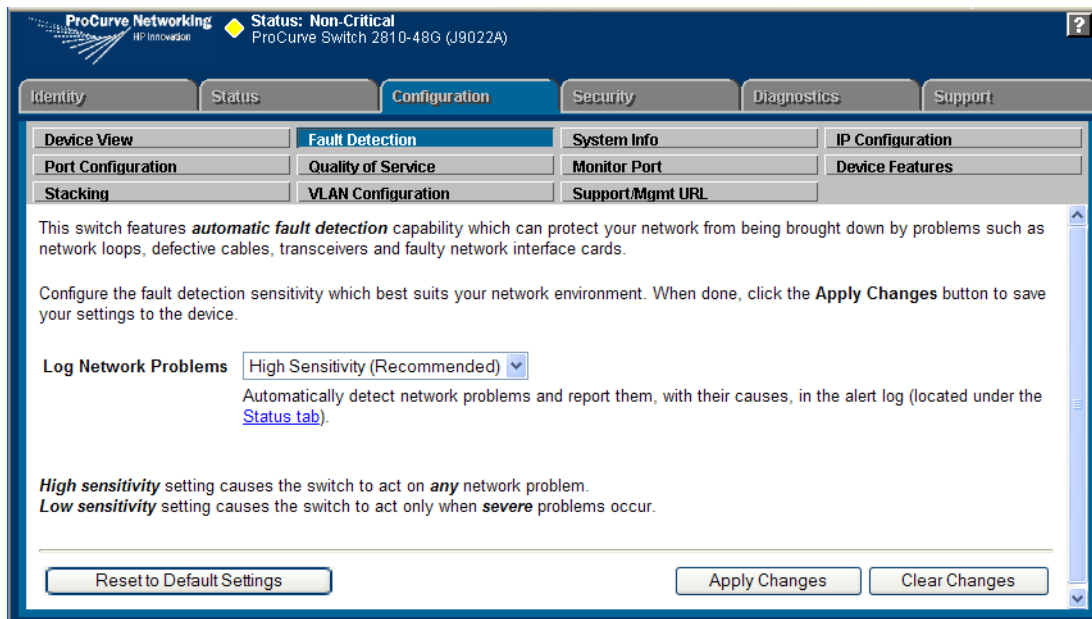

Figure 5-16. The Fault Detection Window

The Fault Detection screen contains a list box for setting fault detection and response policy. You set the sensitivity level at which a network problem should generate an alert and send it to the Alert Log.

To provide the most information on network problems in the Alert Log, the recommended sensitivity level for **Log Network Problems** is **High Sensitivity**. The Fault Detection settings are:

- **High Sensitivity.** This policy directs the switch to send all alerts to the Alert Log. This setting is most effective on networks that have none or few problems.
- **Medium Sensitivity.** This policy directs the switch to send alerts related to network problems to the Alert Log. If you want to be notified of problems which cause a noticeable slowdown on the network, use this setting.
- **Low Sensitivity.** This policy directs the switch to send only the most severe alerts to the Alert Log. This policy is most effective on a network that normally has a lot of problems and you want to be informed of only the most severe ones.

- **Never.** Disables the Alert Log and transmission of alerts (traps) to the management server (in cases where a network management tool such as ProCurve Manager is in use). Use this option when you don't want to use the Alert Log.

The Fault Detection Window also contains three Change Control Buttons:

- **Apply Changes.** This button stores the settings you have selected for all future sessions with the web browser interface until you decide to change them.
- **Clear Changes.** This button removes your settings and returns the settings for the list box to the level it was at in the last saved detection-setting session.
- **Reset to Default Settings.** This button reverts the policy setting to Medium Sensitivity for Log Network Problems.

Switch Memory and Configuration

Contents

Overview	6-2
Overview of Configuration File Management	6-2
Using the CLI To Implement Configuration Changes	6-5
Using the Menu and Web Browser Interfaces To Implement Configuration Changes	6-8
Configuration Changes Using the Menu Interface	6-8
Using Save and Cancel in the Menu Interface	6-9
Rebooting from the Menu Interface	6-10
Configuration Changes Using the Web Browser Interface	6-11
Using Primary and Secondary Flash Image Options	6-12
Displaying the Current Flash Image Data	6-12
Switch Software Downloads	6-14
Local Switch Software Replacement and Removal	6-15
Rebooting the Switch	6-17
Booting from the Current Software Version	6-19
Operating Notes	6-21

Overview

This chapter describes:

- How switch memory manages configuration changes
 - How the CLI implements configuration changes
 - How the menu interface and web browser interface implement configuration changes
 - How the switch provides software options through primary/secondary flash image options
 - How to use the switch's primary and secondary flash options, including displaying flash information, booting or restarting the switch, and other topics
-

Overview of Configuration File Management

The switch maintains two configuration files, the *running-config* file and the *startup-config* file.

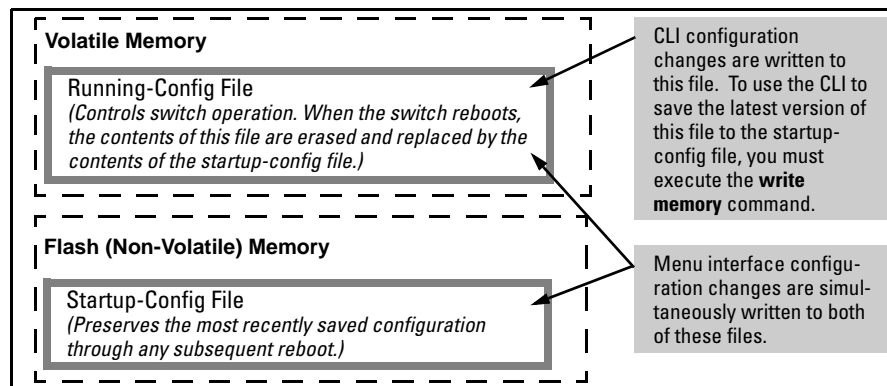

Figure 6-1. Conceptual Illustration of Switch Memory Operation

- **Running Config File:** Exists in volatile memory and controls switch operation. If no configuration changes have been made in the CLI since the switch was last booted, the running-config file is identical to the startup-config file.
- **Startup-config File:** Exists in flash (non-volatile) memory and is used to preserve the most recently-saved configuration as the "permanent" configuration.

Rebooting the switch replaces the current running-config file with a new running-config file that is an exact copy of the current startup-config file.

Note

Any of the following actions reboots the switch:

- Executing the **boot** or the **reload** command in the CLI
- Executing the **Reboot** command in the menu interface
- Pressing the Reset button on the front of the switch
- Removing, then restoring power to the switch

For more on reboots and the switch's dual-flash images, see "Using Primary and Secondary Flash Image Options" on page 6-12.

Options for Saving a New Configuration. Making one or more changes to the running-config file creates a new operating configuration. *Saving* a new configuration means to overwrite (replace) the current startup-config file with the current running-config file. This means that if the switch subsequently reboots for any reason, it will resume operation using the new configuration instead of the configuration previously defined in the startup-config file. There are three ways to save a new configuration:

- **In the CLI:** Use the **write memory** command. This overwrites the current startup-config file with the contents of the current running-config file.
- **In the menu interface:** Use the **Save** command. This overwrites *both* the running-config file and the startup-config file with the changes you have specified in the menu interface screen.
- **In the web browser interface:** Use the **Apply Changes** button or other appropriate button. This overwrites *both* the running-config file and the startup-config file with the changes you have specified in the web browser interface window.

Note that using the CLI instead of the menu or web browser interface gives you the option of changing the running configuration without affecting the startup configuration. This allows you to test the change without making it

“permanent”. When you are satisfied that the change is satisfactory, you can make it permanent by executing the **write memory** command. For example, suppose you use the following command to disable port 5:

```
ProCurve(config)# interface ethernet 5 disable
```

The above command disables port 5 in the running-config file, but not in the startup-config file. Port 5 remains disabled only until the switch reboots. If you want port 5 to remain disabled through the next reboot, use **write memory** to save the current running-config file to the startup-config file in flash memory.

```
ProCurve(config)# write memory
```

If you use the CLI to make a configuration change and then change from the CLI to the Menu interface without first using write memory to save the change to the startup-config file, then the switch prompts you to save the change. For example, if you use the CLI to create VLAN 20, and then select the menu interface, VLAN 20 is configured in the running-config file, but not in the startup-config file. In this case you will see:

```
ProCurve(config)# vlan 20
ProCurve(config)# menu
Do you want to save current configuration [y/n]?
```

If you type **[Y]**, the switch overwrites the startup-config file with the running-config file, and your configuration change(s) will be preserved across reboots. If you type **[N]**, your configuration change(s) will remain only in the running-config file. In this case, if you do not subsequently save the running-config file, your unsaved configuration changes will be lost if the switch reboots for any reason.

Storing and Retrieving Configuration Files. You can store or retrieve a backup copy of the startup-config file on another device. For more information, see appendix A, “File Transfers” .

Using the CLI To Implement Configuration Changes

The CLI offers these capabilities:

- Access to the full set of switch configuration features
- The option of testing configuration changes before making them permanent

How To Use the CLI To View the Current Configuration Files. Use **show** commands to view the configuration for individual features, such as port status or Spanning Tree Protocol. However, to view either the entire startup-config file or the entire running-config file, use the following commands:

- **show config** — Displays a listing of the current startup-config file.
- **show running-config** — Displays a listing of the current running-config file.
- **write terminal** — Displays a listing of the current running-config file.
- **show config status** — Compares the startup-config file to the running-config file and lists one of the following results:
 - If the two configurations are the same you will see:
 - Running configuration is the same as the startup configuration.
 - If the two configurations are different, you will see:
 - Running configuration has been changed and needs to be saved.

Note

Show config, **show running-config**, and **write terminal** commands display the configuration settings that differ from the switch's factory-default configuration.

How To Use the CLI To Reconfigure Switch Features. Use this procedure to permanently change the switch configuration (that is, to enter a change in the startup-config file).

1. Use the appropriate CLI commands to reconfigure the desired switch parameters. This updates the selected parameters in the running-config file.
2. Use the appropriate **show** commands to verify that you have correctly made the desired changes.

3. Observe the switch's performance with the new parameter settings to verify the effect of your changes.
4. When you are satisfied that you have the correct parameter settings, use the **write memory** command to copy the changes to the startup-config file.

Syntax: write memory

For example, the default port mode setting is **auto**. Suppose that your network uses Cat 3 wiring and you want to connect the switch to another autosensing device capable of 100 Mbps operation. Because 100 Mbps over Cat 3 wiring can introduce transmission problems, the recommended port mode is **auto-10**, which allows the port to negotiate full- or half-duplex, but restricts speed to 10 Mbps. The following command configures port A5 to auto-10 mode in the running-config file, allowing you to observe performance on the link without making the mode change permanent.

```
ProCurve(config)# interface e a5 speed-duplex auto-10
```

After you are satisfied that the link is operating properly, you can save the change to the switch's permanent configuration (the startup-config file) by executing the following command:

```
ProCurve(config)# write memory
```

The new mode (**auto-10**) on port A5 is now saved in the startup-config file, and the startup-config and running-config files are identical. If you subsequently reboot the switch, the **auto-10** mode configuration on port A5 will remain because it is included in the startup-config file.

How To Cancel Changes You Have Made to the Running-Config File.

If you use the CLI to change parameter settings in the running-config file, and then decide that you don't want those changes to remain, you can use either of the following methods to remove them:

- Manually enter the earlier values you had for the changed settings. (This is recommended if you want to restore a small number of parameter settings to their previous boot-up values.)
- Update the running-config file to match the startup-config file by rebooting the switch. (This is recommended if you want to restore a larger number of parameter settings to their previous boot-up values.)

If you use the CLI to change a parameter setting, and then execute the **boot** command without first executing the **write memory** command to save the change, the switch prompts you to specify whether to save the changes in the current running-config file. For example:

```
Disables port 1 in the running configuration, which causes port 1 to block all traffic.
ProCurve(config)# interface e 1 disable
ProCurve(config)# boot
Device will be rebooted, do you want to continue [y/n]? y
Press [Y] to continue the rebooting process.
You will then see this prompt.
Do you want to save current configuration [y/n]?
```

Figure 6-2. Boot Prompt for an Unsaved Configuration

The above prompt means that one or more parameter settings in the running-config file differ from their counterparts in the startup-config file and you need to choose which config file to retain and which to discard.

- If you want to update the startup-config file to match the running-config file, press **[Y]** for "yes". (This means that the changes you entered in the running-config file will be saved in the startup-config file.)
- If you want to discard the changes you made to the running-config file so that it will match the startup-config file, then press **[N]** for "no". (This means that the switch will discard the changes you entered in the running-config file and will update the running-config file to match the startup-config file.)

Note

If you use the CLI to make a change to the running-config file, you should either use the **write memory** command or select the save option allowed during a reboot (figure 6-2, above) to save the change to the startup-config file. That is, if you use the CLI to change a parameter setting, but then reboot the switch from either the CLI or the menu interface without first executing the **write memory** command in the CLI, the current startup-config file will replace the running-config file, and any changes in the running-config file will be lost.

Using the **Save** command in the menu interface does not save a change made to the running config by the CLI unless you have also made a configuration change in the menu interface. Also, the menu interface displays the current running-config values. Thus, where a parameter setting is accessible from both the CLI and the menu interface, if you change the setting in the CLI, the new value will appear in the menu interface display for that parameter. *However, as indicated above, unless you also make a configuration change in the menu interface, only the **write memory** command in the CLI will actually save the change to the startup-config file.*

How To Reset the startup-config and running-config Files to the Factory-Default Configuration. This command reboots the switch, replacing the contents of the current startup-config and running-config files with the factory-default startup configuration.

Syntax: erase startup-config

For example:

```
ProCurve(config)# erase startup-config
Configuration will be deleted and device rebooted, continue [y/n]?
```

Figure 6-3. Resetting to the Factory-Default Configuration

Press **[Y]** to replace the current configuration with the factory default configuration and reboot the switch. Press **[N]** to retain the current configuration and prevent a reboot.

Using the Menu and Web Browser Interfaces To Implement Configuration Changes

The menu and web browser interfaces offer these advantages:

- Quick, easy menu or window access to a subset of switch configuration features (See the “Menu Features List” on page 3-14 and the web browser “General Features” list on page.)
- Viewing several related configuration parameters in the same screen, with their default and current settings
- Immediately changing both the running-config file and the startup-config file with a single command

Configuration Changes Using the Menu Interface

You can use the menu interface to simultaneously save and implement a subset of switch configuration changes without having to reboot the switch. That is, when you save a configuration change in the menu interface, you simultaneously change both the running-config file and the startup-config file.

Note

The only exception to this operation are two VLAN-related parameter changes that require a reboot—described under “Rebooting To Activate Configuration Changes” on page 6-11.

Using **Save** and **Cancel** in the Menu Interface

For any configuration screen in the menu interface, the Save command:

1. Implements the changes in the running-config file.
2. Saves your changes to the startup-config file.

If you decide not to save and implement the changes in the screen, select **Cancel** to discard them and continue switch operation with the current operation. For example, suppose you have made the changes shown below in the System Information screen:

To save and implement the changes for all parameters in this screen, press the **[Enter]** key, then press **[S]** (for **Save**). To cancel all changes, press the **[Enter]** key, then press **[C]** (for **Cancel**)

```

===== CONSOLE - MANAGER MODE =====
Switch Configuration - System Information

System Name : ProCurve 2810
System Contact : Extension 5440
System Location : System Support Office, Floor 2, Room 231

Inactivity Timeout (min) [0] : 0      Address Age Interval (min) [5] : 5
Inbound Telnet Enabled [Yes] : Yes    Web Agent Enabled [Yes] : Yes

Time Zone [0] : 8
Daylight Time Rule [None] : Continental-US-and-Canada

Actions->  _Cancel      _Edit      _Save      _Help

Select Daylight Time Rule for your location.
Use arrow keys to change field selection, <Space> to toggle field choices,
and <Enter> to go to Actions.

```

Figure 6-4. Example of Pending Configuration Changes that Can Be Saved or Cancelled

Switch Memory and Configuration

Using the Menu and Web Browser Interfaces To Implement Configuration Changes

Note

If you reconfigure a parameter in the CLI and then go to the menu interface without executing a **write memory** command, those changes are stored only in the running configuration. If you then execute a switch reboot command in the menu interface, the switch discards the configuration changes made while using the CLI. To ensure that changes made while using the CLI are saved, execute **write memory** in the CLI before rebooting the switch.

Rebooting from the Menu Interface

- Terminates the current session and performs a reset of the operating system
- Activates any configuration changes that require a reboot
- Resets statistical counters to zero

(Note that statistical counters can be reset to zero without rebooting the switch. See “Displaying Port Counters” on “To Display the Port Counter Summary Report” on page B-12.)

To Reboot the switch, use the **Reboot Switch** option in the Main Menu. (Note that the Reboot Switch option is not available if you log on in Operator mode, that is, if you enter an Operator password instead of a manager password at the password prompt.)

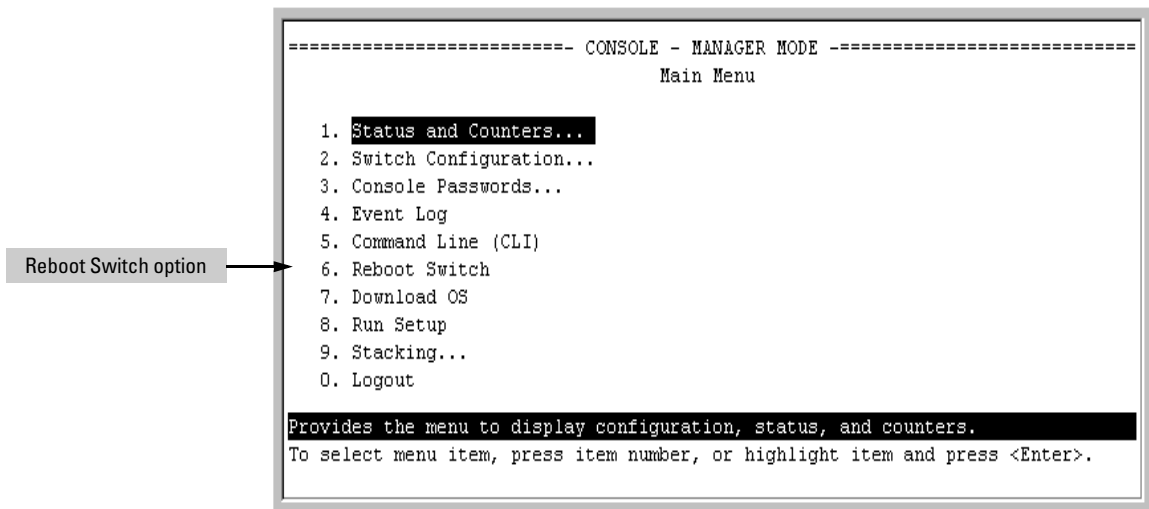

Figure 6-5. The Reboot Switch Option in the Main Menu

Rebooting To Activate Configuration Changes. Configuration changes for most parameters become effective as soon as you save them. However, you must reboot the switch in order to implement a change in the **Maximum VLANs to support** parameter.

(To access these parameters, go to the Main menu and select **2. Switch Configuration**, then **8. VLAN Menu**, then **1. VLAN Support**.)

If configuration changes requiring a reboot have been made, the switch displays an asterisk (*) next to the menu item in which the change has been made. For example, if you change and save parameter values for the **Maximum VLANs to support** parameter, an asterisk appears next to the **VLAN Support** entry in the VLAN Menu screen, and also next to the **Switch Configuration . . .** entry in the Main menu, as shown in figure 4-6:

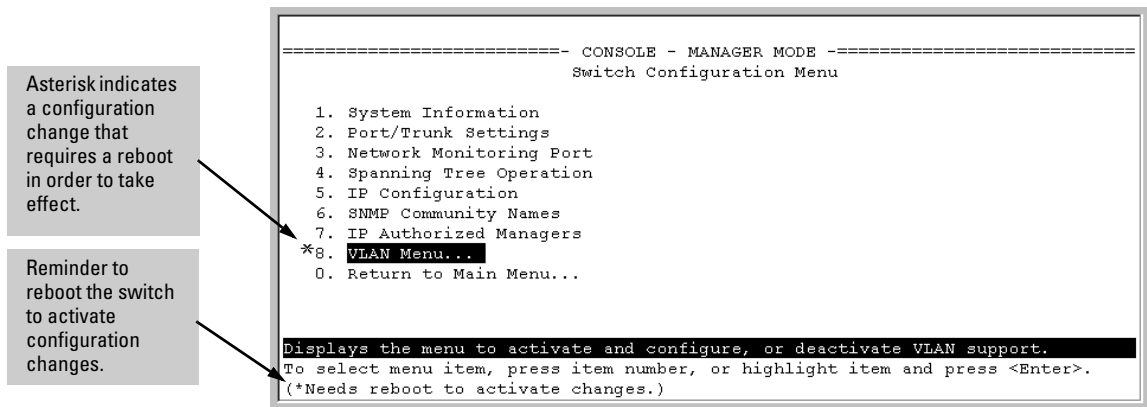

Figure 6-6. Indication of a Configuration Change Requiring a Reboot

Configuration Changes Using the Web Browser Interface

You can use the web browser interface to simultaneously save and implement a subset of switch configuration changes without having to reboot the switch. That is, when you save a configuration change (in most cases, by clicking on **Apply Changes** or **Apply Settings**, you simultaneously change both the running-config file and the startup-config file.

Note

If you reconfigure a parameter in the CLI and then go to the browser interface without executing a **write memory** command, those changes will be saved to the startup-config file if you click on **Apply Changes** or **Apply Settings** in the web browser interface.

Using Primary and Secondary Flash Image Options

The switch features two flash memory locations for storing switch software image files:

- **Primary Flash:** The default storage for a switch software image.
- **Secondary Flash:** The additional storage for either a redundant or an alternate switch software image.

With the Primary/Secondary flash option you can test a new image in your system without having to replace a previously existing image. You can also use the image options for troubleshooting. For example, you can copy a problem image into Secondary flash for later analysis and place another, proven image in Primary flash to run your system. The switch can use only one image at a time.

The following tasks involve primary/secondary flash options:

- Displaying the current flash image data and determining which switch software versions are available
- Switch software downloads
- Replacing and removing (erasing) a local switch software version
- System booting

Displaying the Current Flash Image Data

Use the commands in this section to:

- Determine whether there are flash images in both primary and secondary flash
- Determine whether the images in primary and secondary flash are the same
- Identify which switch software version is currently running

Viewing the Currently Active Flash Image Version. This command identifies the software version on which the switch is currently running, and whether the active version was booted from the primary or secondary flash image.

Syntax: show version

For example, if the switch is using a software version of N.10.XX stored in Primary flash, **show version** produces the following:

```
ProCurve(config)# show version
Image stamp:      /sw/code/build/bass(ppne_swt)
                  Mar 17 2006 11:44:02
                  N.10.XX
                  2624
Boot Image:      Primary
Build Options:   QA
Watchdog:        ENABLED
```

Figure 6-7. Example Showing the Identity of the Current Flash Image

Determining Whether the Flash Images Are Different Versions. If the flash image sizes in primary and secondary are the same, then in almost every case, the primary and secondary images are identical. This command provides a comparison of flash image sizes, plus the boot ROM version and from which flash image the switch booted. For example, in the following case, the images are different versions of the switch software and the switch is running on the version stored in the secondary flash image:

```
ProCurve(config)# show flash
Image           Size(Bytes)   Date    Version  Build #
-----
Primary Image   : 3224515     03/17/06 N.10.XX  2624
Secondary Image : 3220653     02/15/06 N.10.XX  728
Boot Rom Version: N.10.XA
Current Boot    : Primary

ProCurve(config)#
```

The unequal code size and differing dates indicate two different versions of the software.

Figure 6-8. Example Showing Different Flash Image Versions

Determining Which Flash Image Versions Are Installed. The **show version** command displays which software version the switch is currently running and whether that version booted from primary or secondary flash. Thus, if the switch booted from primary flash, you will see the version number of the software image stored in primary flash, and if the switch booted from secondary flash, you will see the version number of the software version stored in secondary flash. Thus, by using **show version**, then rebooting the switch from the opposite flash image and using **show version** again, you can determine the version(s) of switch software in both flash sources. For example:

Switch Memory and Configuration

Using Primary and Secondary Flash Image Options

1. In this example **show version** indicates the switch has version N.10.XX in primary flash.

2. After the **boot system** command, **show version** indicates that version N.10.XX is in secondary flash.

```

ProCurve(config)# show version
Image stamp:    /sw/code/build/bass(ppne_swt)
                Mar 17 2006 11:44:02
                N.10.XX
                2624
Boot Image:     Primary
Build Options:  QA
Watchdog:       ENABLED

ProCurve(config)# boot system flash secondary
Device will be rebooted, do you want to continue [y/n]? y

ProCurve(config)# show version
Image stamp:    /sw/code/build/bass(ppne_swt)
                Mar 17 2006 11:44:02
                N.10.XX
                2624
Boot Image:     Secondary
Build Options:  QA
Watchdog:       ENABLED

ProCurve(config)#

```

Figure 6-9. Determining the Software Version in Primary and Secondary Flash

Switch Software Downloads

The following table shows the switch's options for downloading a software version to flash and booting the switch from flash

Table 6-1. Primary/Secondary Memory Access

Action	Menu	CLI	Web Browser	SNMP
Download to Primary	Yes	Yes	Yes	Yes
Download to Secondary	No	Yes	No	Yes
Boot from Primary	Yes	Yes	Yes	Yes
Boot from Secondary	No	Yes	No	Yes

The different software download options involve different **copy** commands, plus **xmodem**, and **tftp**. These topics are covered in Appendix A, "File Transfers".

Download Interruptions. In most cases, if a power failure or other cause interrupts a flash image download, the switch reboots with the image previously stored in primary flash. In the unlikely event that the primary image is

corrupted, as a result of an interruption, the switch will reboot from secondary flash and you can either copy the secondary image into primary or download another image to primary from an external source. See Appendix A, “File Transfers”.

Local Switch Software Replacement and Removal

This section describes commands for erasing a software version and copying an existing software version between primary and secondary flash.

Note

It is not necessary to erase the content of a flash location before downloading another software file. The process automatically overwrites the previous file with the new file. If you want to remove an unwanted software version from flash, ProCurve recommends that you do so by overwriting it with the same software version that you are using to operate the switch, or with another acceptable software version. To copy a software file between the primary and secondary flash locations, see “Copying a Switch Software Image from One Flash Location to Another”, below.

The local commands described here are for flash image management within the switch. To download a software image file from an external source, see Appendix A, “File Transfers”.

Copying a Switch Software Image from One Flash Location to Another. When you copy the flash image from primary to secondary or the reverse, the switch overwrites the file in the destination location with a copy of the file from the source location. This means you *do not* have to erase the current image at the destination location before copying in a new image.

Caution

Verify that there is an acceptable software version in the source flash location from which you are going to copy. Use the **show flash** command or, if necessary, the procedure under “Determining Which Flash Image Versions Are Installed” on page 6-13 to verify an acceptable software version. Attempting to copy from a source image location that has a corrupted flash image overwrites the image in the destination flash location. In this case, the switch will not have a valid flash image in either flash location, but will continue running on a temporary flash image in RAM. *Do not reboot the switch.* Instead, immediately download another valid flash image to primary or secondary flash. Otherwise, if the switch is rebooted without a software image in either primary or secondary flash, the temporary flash image in RAM will be cleared and the switch will go down. To recover, see “Restoring a Flash Image” on page C-44 (in the Troubleshooting chapter).

Syntax: **copy flash flash <destination flash>**

where: **destination flash** = **primary** or **secondary**:

For example, to copy the image in secondary flash to primary flash:

1. Verify that there is a valid flash image in the secondary flash location. The following figure indicates that a software image is present in secondary flash. (If you are unsure whether the image in secondary flash is valid, try booting from it before you proceed, by using **boot system flash secondary**.)

```
ProCurve# show flash
Image             Size(Bytes)   Date   Version   Build #
-----
Primary Image    : 3224515   03/17/06 N.10.XX   2624
Secondary Image  : 3220653 ← 02/15/06 N.10.XX   728
Boot Rom Version: N.10.XA
Current Boot     : Primary

ProCurve#
```

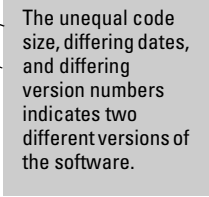

Figure 6-10. Example Indicating Two Different Software Versions in Primary and Secondary Flash

Execute the copy command as follows:

```
ProCurve(config)# copy flash flash primary
```

Erasing the Contents of Primary or Secondary Flash. This command deletes the software image file from the specified flash location.

Caution--No Undo!

Before using this command in one flash image location (primary or secondary), ensure that you have a valid software file in the other flash image location (secondary or primary). If the switch has only one flash image loaded (in either primary or secondary flash) and you erase that image, then the switch does not have a software image stored in flash. In this case, if you do not reboot or power cycle the switch, you can recover by using xmodem or tftp to download another software image.

Syntax: erase flash < primary | secondary >

For example, to erase the software image in primary flash, do the following:

1. First verify that a usable flash image exists in secondary flash. The most reliable way to ensure this is to reboot the switch from the flash image you want to retain. For example, if you are planning to erase the primary image, then first reboot from the secondary image to verify that the secondary image is present and acceptable for your system:

```
ProCurve# boot system flash secondary
```

2. Then erase the software image in the selected flash (in this case, primary):

```
ProCurve# erase flash primary
The Primary OS Image will be deleted, continue [y/n]? _
```

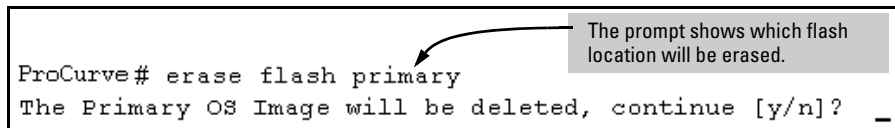

Figure 6-11. Example of Erase Flash Prompt

3. Type **y** at the prompt to complete the flash erase.
4. Use **show flash** to verify erasure of the selected software flash image

```
ProCurve# show flash
Compressed Primary Code size    = 0
Compressed Secondary Code size = 2555802
Boot Rom Version: N.10.XA
Current Boot      : Secondary
```

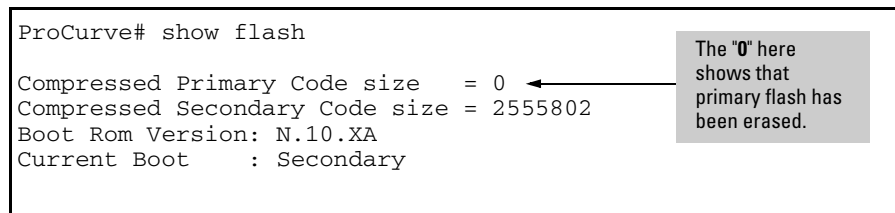

Figure 6-12. Example of Show Flash Listing After Erasing Primary Flash

Rebooting the Switch

The switch offers reboot options through the **boot** and **reload** commands, plus the options inherent in a dual-flash image system. Generally, using **boot** provides more comprehensive self-testing; using **reload** gives you a faster reboot time.

Table 6-2. Comparing the Boot and Reload Commands

Actions	Included In Boot?	Included In Reload	Note
Save all configuration changes since the last boot or reload	Optional, with prompt	Yes, automatic	Config changes saved to the startup-config file
Perform all system self-tests	Yes	No	Reload provides a faster system reboot.
Choice of primary or secondary	Yes	No—Uses the current flash image.	

Booting from Primary Flash. This command always boots the switch from primary flash, and executes the complete set of subsystem self-tests.

Syntax: boot

For example, to boot the switch from primary flash with pending configuration changes in the running-config file:

```
ProCurve(config)# boot
Device will be rebooted, do you want to continue [y/n]? y
Boot from primary flash
Do you want to save current configuration [y/n]? _
```

Figure 6-13. Example of Boot Command (Default Primary Flash)

In the above example, typing either a **y** or **n** at the second prompt initiates the reboot operation. Also, if there are no pending configuration changes in the running-config file, then the reboot commences without the pause to display `Boot from primary flash`.

Booting from a Specified Flash. This version of the boot command gives you the option of specifying whether to reboot from primary or secondary flash, and is the required command for rebooting from secondary flash. This option also executes the complete set of subsystem self-tests.

Syntax: boot system flash < primary | secondary >

For example, to reboot the switch from secondary flash when there are no pending configuration changes in the running-config file:

```
ProCurve(config)# boot system flash secondary
Device will be rebooted, do you want to continue [y/n]? y
Boot from secondary flash
Do you want to save current configuration [y/n]? _
```

Figure 6-14. Example of Boot Command with Primary/Secondary Flash Option

In the above example, typing either a **y** or **n** at the second prompt initiates the reboot operation. Also, if there are no pending configuration changes in the running-config file, then the reboot commences without the pause to display `Boot from secondary flash`.

Booting from the Current Software Version

The **reload** command reboots the switch from the flash image on which the switch is currently running, and saves to the startup-config file any configuration changes currently in the running-config file. Because **reload** bypasses some subsystem self-tests, the switch reboots faster than if you use either of the **boot** command options.

Syntax: **reload**

For example, if you change the number of VLANs the switch supports, you must reboot the switch in order to implement the change. Reload automatically saves your configuration changes and reboots the switch from the same software image you have been using:

```
ProCurve(config)# max-vlans 12
Command will take effect after saving configuration and reboot.
ProCurve(config)# reload
Device will be rebooted, do you want to continue [y/n]? y
Do you want to save current configuration [y/n]? _
```

Figure 6-15. Using Reload with Pending Configuration Changes

Scheduled Reload. Additional parameters have been added to the **reload** command to allow for a scheduled reboot of the switch via the CLI.

Syntax: [no] reload [after <[dd:]hh:]mm> | at <hh:mm[:ss]> [<mm/dd[/[yy]yy]>]]

Enables a scheduled warm reboot of the switch. The switch boots up with the same startup config file and using the same flash image as before the reload.

Parameters include:

- **after:** Schedules a warm reboot of the switch after a given amount of time has passed.
- **at:** Schedules a warm reboot of the switch at a given time.

*The **no** form of the command removes a pending reboot request. For more details and examples, see below.*

The scheduled reload feature removes the requirement to physically reboot the switch at inconvenient times (for example, at 1:00 in the morning). Instead, a **reload at 1:00 mm/dd** command can be executed (where *mm/dd* is the date the switch is scheduled to reboot).

Note

Configuration changes are not saved with **reload at** or **reload after** commands. No prompt to save configuration file changes is displayed.

Examples of scheduled **reload** commands:

- To schedule a reload in 15 minutes:
ProCurve# reload after 15
- To schedule a reload in 3 hours:
ProCurve# reload after 03:00
- To schedule a reload for the same time the following day:
ProCurve# reload after 01:00:00
- To schedule a reload for the same day at 12:05:
ProCurve# reload at 12:05
- To schedule a reload on some future date:
ProCurve# reload at 12:05 01/01/2008

Operating Notes

Default Boot Source. The switch reboots from primary flash by default unless you specify the secondary flash.

Boot Attempts from an Empty Flash Location. In this case, the switch aborts the attempt and displays

```
Image does not exist
Operation aborted.
```

Interaction of Primary and Secondary Flash Images with the Current Configuration. The switch has one startup-config file (page 6-2), which it always uses for reboots, regardless of whether the reboot is from primary or secondary flash. Also, for rebooting purposes, it is not necessary for the software image and the startup-config file to support identical software features. For example, suppose you have just downloaded a software upgrade that includes new features that are not supported in the software you used to create the current startup-config file. In this case, the software simply assigns factory-default values to the parameters controlling the new features. Similarly, if you create a startup-config file while using a version “Y” of the switch software, and then reboot the switch with an earlier software version “X” that does not include all of the features found in “Y”, the software simply ignores the parameters for any features that it does not support.

Scheduled Reload. If no parameters are entered after the **reload** command, an immediate reboot is executed. The **reload at** and **reload after** command information is not saved across reboots. If the switch is rebooted before a scheduled reload command is executed, the command is effectively cancelled. When entering a **reload at** or **reload after** command, a prompt will appear to confirm the command before it can be processed by the switch. For the **reload at** command, if *mm/dd/yy* are left blank, the current day is assumed.

The scheduled reload feature removes the requirement to physically reboot the switch at inconvenient times (for example, at 1:00 in the morning). Instead, a **reload at 1:00 mm/dd** command can be executed (where *mm/dd* is the date the switch is scheduled to reboot).

Switch Memory and Configuration
Using Primary and Secondary Flash Image Options

Interface Access and System Information

Contents

Overview	7-2
Interface Access: Console/Serial Link, Web, and Telnet	7-3
Menu: Modifying the Interface Access	7-4
CLI: Modifying the Interface Access	7-5
Denying Interface Access by Terminating Remote Management Sessions	7-10
System Information	7-11
Menu: Viewing and Configuring System Information	7-12
CLI: Viewing and Configuring System Information	7-13
Web: Configuring System Parameters	7-16

Overview

This chapter describes how to:

- View and modify the configuration for switch interface access
- Use the CLI **kill** command to terminate a remote session
- View and modify switch system information

For help on how to actually use the interfaces built into the switch, refer to:

- Chapter 2, “Using the Menu Interface”
- Chapter 4, “Using the Command Line Interface (CLI)”
- Chapter 5, “Using the Web Browser Interface”

Why Configure Interface Access and System Information? The interface access features in the switch operate properly by default. However, you can modify or disable access features to suit your particular needs. Similarly, you can choose to leave the system information parameters at their default settings. However, modifying these parameters can help you to more easily distinguish one device from another in your network.

Interface Access: Console/Serial Link, Web, and Telnet

Interface Access Features

Feature	Default	Menu	CLI	Web
Inactivity Time	0 Minutes (disabled)	page 7-4	page 7-6	—
Inbound Telnet Access	Enabled	page 7-4	page 7-5	—
Outbound Telnet Access	n/a	—	page 7-6	—
Web Browser Interface Access	Enabled	page 7-4	page 7-6	—
Terminal type	VT-100	—	page 7-6	—
Event Log event types to list (Displayed Events)	All	—	page 7-6	—
Baud Rate	Speed Sense	—	page 7-6	—
Flow Control	XON/XOFF	—	page 7-6	—

In most cases, the default configuration is acceptable for standard operation.

Note

Basic switch security is through passwords. You can gain additional security by using the security features described in the Access Security Guide for your switch. You can also simply block unauthorized access via the web browser interface or Telnet (as described in this section) and install the switch in a locked environment.

Menu: Modifying the Interface Access

The menu interface enables you to modify these parameters:

- Inactivity Time-out
- Inbound Telnet Enabled
- Web Agent Enabled

To Access the Interface Access Parameters:

1. From the Main Menu, Select...

2. Switch Configuration...

1. System Information

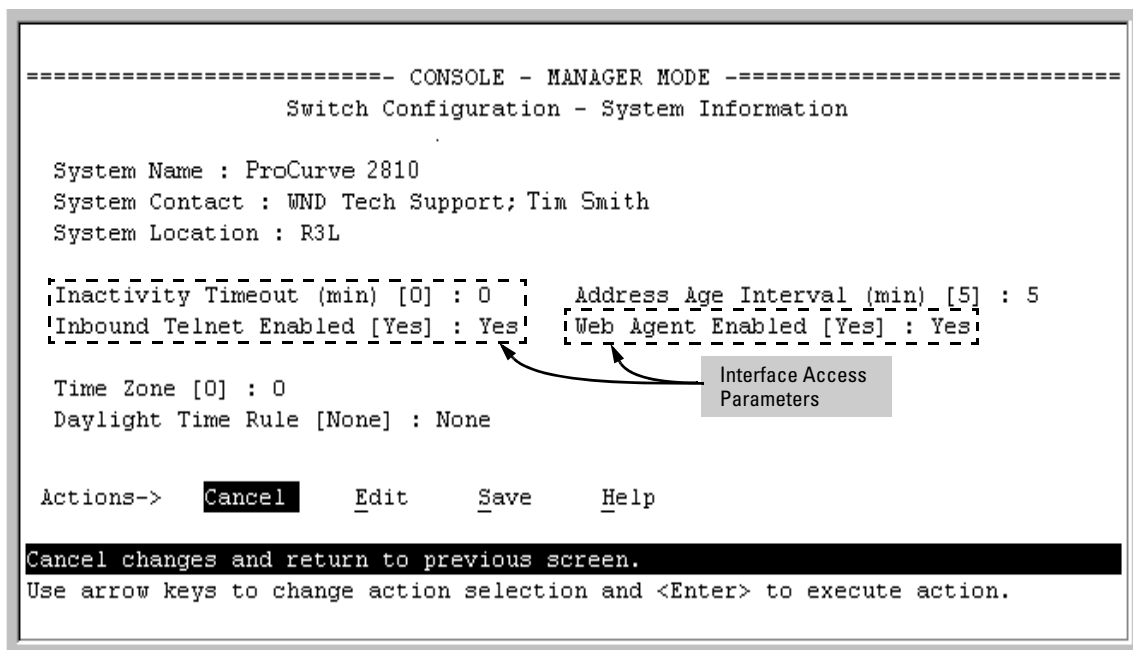

Figure 7-1. The Default Interface Access Parameters Available in the Menu Interface

2. Press [E] (for **Edit**). The cursor moves to the **System Name** field.
3. Use the arrow keys (↓, ↑, ←, →) to move to the parameters you want to change.

Refer to the online help provided with this screen for further information on configuration options for these features.

4. When you have finished making changes to the above parameters, press [Enter], then press [S] (for **Save**).

CLI: Modifying the Interface Access

Interface Access Commands Used in This Section

show console	below
[no] telnet-server	below
[no] web-management	page 7-6
console	page 7-6
local terminal mode	page 7-8

Listing the Current Console/Serial Link Configuration. The following command lists the current interface access parameter settings.

Syntax: show console

This example shows the switch's default console/serial configuration.

Note

The serial connection for the 2810 switch is an RJ45 port located on the left front panel of the switch.

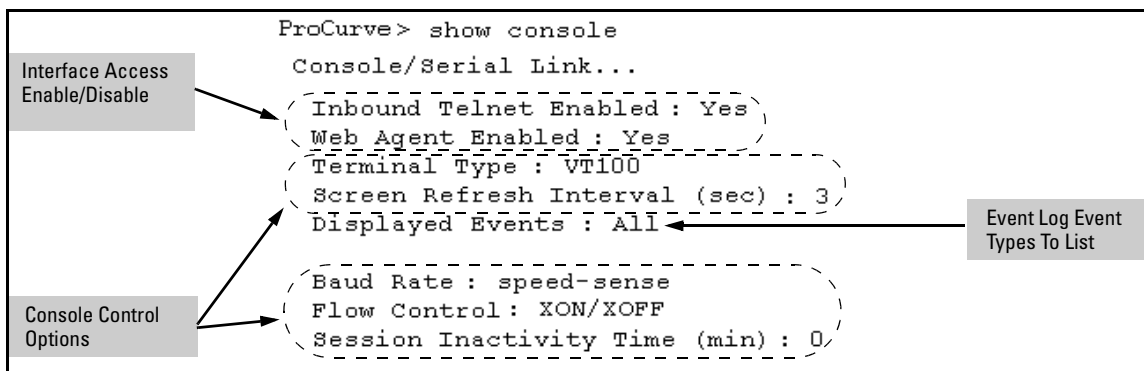

Figure 7-2. Listing of Show Console Command

Reconfigure Inbound Telnet Access. In the default configuration, inbound Telnet access is enabled.

Syntax: [no] telnet-server

To disable inbound Telnet access:

```
ProCurve(config)# no telnet-server
```

Interface Access and System Information

Interface Access: Console/Serial Link, Web, and Telnet

To re-enable inbound Telnet access:

```
ProCurve(config)# telnet-server
```

Outbound Telnet to Another Device. This feature operates independently of the telnet-server status and enables you to Telnet to another device that has an IP address.

Syntax: telnet <ip-address>

For example:

```
ProCurve# telnet 10.28.27.204
```

Reconfigure Web Browser Access. In the default configuration, web browser access is enabled.

Syntax: [no] web-management

To disable web browser access:

```
ProCurve(config)# no web-management
```

To re-enable web browser access:

```
ProCurve(config)# web-management
```

Reconfigure the Console/Serial Link Settings. You can reconfigure one or more console parameters with one console command.

Syntax: console
[terminal <vt100 | ansi>]
[screen-refresh <1 | 3 | 5 | 10 | 20 | 30 | 45 | 60>]
[baud-rate
 <speed-sense | 1200 | 2400 | 4800 | 9600 | 19200 | 38400 | 57600>]
[flow-control <xon/xoff | none>]
[inactivity-timer <0 1 5 10 15 20 30 60 120>]
[events <none | all | non-info | critical | debug>]

Note

If you change the Baud Rate or Flow Control settings for the switch, you should make the corresponding changes in your console access device. Otherwise, you may lose connectivity between the switch and your terminal emulator due to differences between the terminal and switch settings for these two parameters.

Changes to console parameters require that you perform a **write memory** and then execute **boot** before the new console configuration will take effect. To enable temporary and non-disruptive changes to the terminal mode without requiring a reboot, use the **console local terminal** command (see page 7-8).

For example, to use one command to configure the switch with the following:

- VT100 operation
- 19,200 baud
- No flow control
- 10-minute inactivity time
- Critical log events

you would use the following command sequence:

```
ProCurve(config)# console terminal vt100 baud-rate 19200 flow-control none
inactivity-timer 10 events critical
Command will take effect after saving configuration and reboot.
ProCurve(config)# write memory
ProCurve(config)# reload
```

The switch implements the Event Log change immediately. The switch implements the other console changes after executing **write memory** and **reload**.

Figure 7-3. Example of Executing the Console Command with Multiple Parameters

You can also execute a series of console commands and then save the configuration and boot the switch. For example:

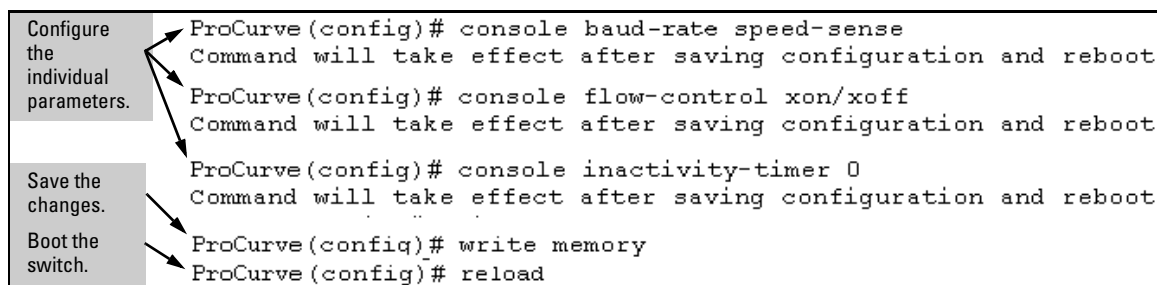

Figure 7-4. Example of Executing a Series of Console Commands

CLI Local Terminal Mode. To enable temporary and non-disruptive changes to the terminal mode without forcing a change in the switch's terminal mode configuration, use the **console local-terminal** command. This command dynamically changes only the console session from which it is executed. Unlike the **console terminal** command, it does not require **write memory** and a reboot, and does not persist across a reboot.

Syntax: `console local-terminal < vt100 | none | ansi >`

*Dynamically converts the terminal mode of a console session to the selected mode. Executing **console local-terminal** affects only the console session from which it is executed. Rebooting the switch returns the terminal mode for the affected console session to the configured terminal mode. This command does not change the configured console terminal mode configuration. (To change the configured terminal mode, use the **console terminal < vt100 | none | ansi >** command, which requires execution of **write memory**, followed by a switch reboot, to take effect.)*

vt100

*When invoked in a console session, changes the terminal mode to VT-100 for that console session. Use this option when the configured terminal mode is either **none** (scripting mode) or **ansi**, and you want to temporarily use the VT-100 mode. (VT-100 is the default terminal mode configuration setting.)*

none

*When invoked in a console session, changes the terminal mode to “raw” (scripting mode) for that console session. (Scripting mode eliminates unwanted control characters that may appear in some scripting languages.) Use this option when the configured terminal mode is either **vt100** or **ansi**, and you want to temporarily use the scripting mode.*

ansi

*When invoked in a console session, changes the terminal mode to ANSI for that console session. Use this option when the configured terminal mode is either **vt100** (scripting mode) or **none**, and you want to temporarily use the ANSI mode.*

Denying Interface Access by Terminating Remote Management Sessions

The switch supports up to four management sessions. You can use **show ip ssh** to list the current management sessions, and **kill** to terminate a currently running remote session. (**Kill** does not terminate a Console session on the serial port, either through a direct connection or via a modem.)

Syntax: **kill** [<session-number>]

For example, if you are using the switch's serial port for a console session and want to terminate a currently active Telnet session, you would do the following:

```
ProCurve(config)# show ip ssh
SSH Enabled           : Yes

IP Port Number       : 22
Timeout (sec)       : 120
Server Key Size (bits) : 512

Ses Type      Source IP and Port
-----
1  console
2  telnet
3  ssh      15.30.252.195:1531
4  inactive

ProCurve(config)# kill 2
ProCurve(config)# show ip ssh
SSH Enabled           : Yes

IP Port Number       : 22
Timeout (sec)       : 120
Server Key Size (bits) : 512

Ses Type      Source IP and Port
-----
1  console
2  inactive
3  ssh      15.30.252.195:1531
4  inactive
```

Figure 7-5. Example of Using the "Kill" Command To Terminate a Remote Session

System Information

System Information Features

Feature	Default	Menu	CLI	Web
System Name	<i>switch product name</i>	page 7-12	page 7-14	page 7-16
System Contact	n/a	page 7-12	page 7-14	page 7-16
System Location	n/a	page 7-12	page 7-14	page 7-16
MAC Age Time	300 seconds	page 7-12	page 7-15	—
Time Sync Method	None	See Chapter 9, “Time Protocols”.		
Time Zone	0	page 7-12	page 7-15	—
Daylight Time Rule	None	page 7-12	page 7-15	—
Time	January 1, 1990 at 00:00:00 at last power reset	—	page 7-15	—

Configuring system information is optional, but recommended.

System Name: Using a unique name helps you to identify individual devices in stacking environments and where you are using an SNMP network management tool such as ProCurve Manager.

System Contact and Location: This information is helpful for identifying the person administratively responsible for the switch and for identifying the locations of individual switches.

MAC Age Interval: The number of seconds a MAC address the switch has learned remains in the switch’s address table before being aged out (deleted). Aging out occurs when there has been no traffic from the device belonging to that MAC address for the configured interval.

Time Sync Method: Selects the method (TimeP or SNTP) the switch will use for time synchronization. For more on this topic, refer to Chapter 9, “Time Protocols”.

Time Zone: The number of minutes your time zone location is to the West (-) or East (+) of Coordinated Universal Time (formerly GMT). The default **0** means no time zone is configured. For example, Berlin, Germany is in the +1 zone, while Vancouver, Canada is in the -8 zone.

Daylight Time Rule: Specifies the daylight savings time rule to apply for your location. The default is **None**. (For more on this topic, see Appendix E, “Daylight Savings Time on ProCurve Switches.”)

Time: Used in the CLI to specify the time of day, the date, and other system parameters.

Menu: Viewing and Configuring System Information

To access the system information parameters:

1. From the Main Menu, Select...
 2. **Switch Configuration...**
 1. **System Information**

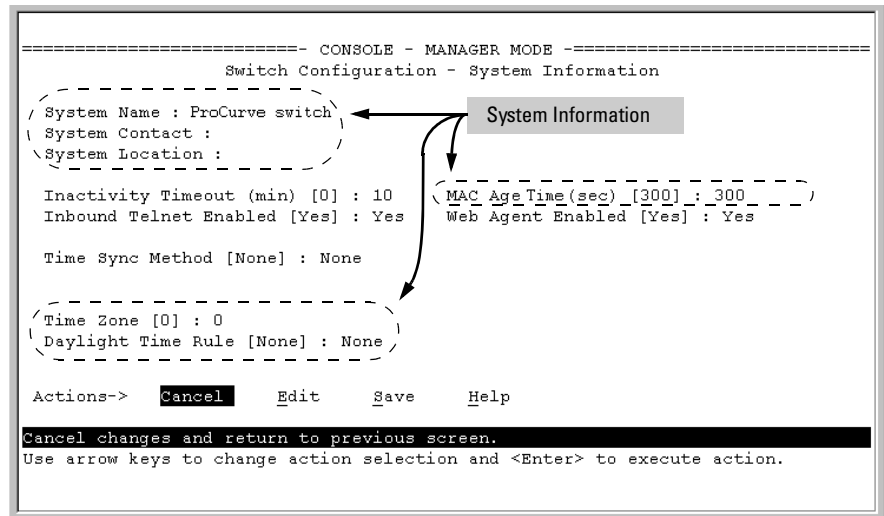

Figure 7-6. The System Information Configuration Screen (Default Values)

Note

To help simplify administration, it is recommended that you configure **System Name** to a character string that is meaningful within your system.

2. Press [E] (for Edit). The cursor moves to the **System Name** field.

3. Refer to the online help provided with this screen for further information on configuration options for these features.
4. When you have finished making changes to the above parameters, press **[Enter]**, then press **[S]** (for **Save**) and return to the Main Menu.

CLI: Viewing and Configuring System Information

System Information Commands Used in This Section

show system-information	below
hostname	below
snmp-server [contact] [location]	below
mac-age-time	page 7-15
time	
time zone	page 7-15
daylight-time-rule	page 7-15
date	page 7-15
time	

Listing the Current System Information. This command lists the current system information settings.

Syntax: show system-information

This example shows the switch's default console configuration.

```
ProCurve > show system-information
Status and Counters - General System Information
System Name       : ProCurve
System Contact    :
System Location   :
MAC Age Interval (sec) : 300
Time Zone         : 0
Daylight Time Rule : None
```

Figure 7-7. Example of CLI System Information Listing

Configure a System Name, Contact, and Location for the Switch. To help distinguish one switch from another, configure a plain-language identity for the switch.

Syntax: hostname <name-string>
 snmp-server [contact <system contact>] [location <system location>]

Both fields allow up to 48 characters. *Blank spaces* are not allowed in the variables for these commands.

For example, to name the switch “Blue” with “Ext-4474” as the system contact, and “North-Data-Room” as the location:

```
ProCurve(config)# hostname Blue
Blue(config)# snmp-server contact Ext-4474 location North-Data-Room
Blue(config)# show system-information

Status and Counters - General System Information
-----
System Name       : Blue
System Contact    : Ext-4474
System Location   : North-Data-Room

MAC Age Interval (sec) : 300

Time Zone         : 0
Daylight Time Rule : None

Firmware revision : N.01.01      Base MAC Addr   : 0001e7-a0ec00
ROM Version       : N.01.01      Serial Number    : S000394041

Up Time          : 14 mins      Memory - Total   : 25,038,312
CPU Util (%)     : 1            Free             : 20,087,448

IP Mgmt - Pkts Rx : 0           Packet - Total   : 832
           Pkts Tx : 0           Buffers Free    : 783
                                   Lowest              : 768

-- MORE --, next page: Space, next line: Enter, quit: Control-C
```

Figure 7-8. System Information Listing After Executing the Preceding Commands

Reconfigure the Age Time for Learned MAC Addresses. This command corresponds to the MAC Age Interval in the menu interface, and is expressed in seconds.

Syntax: mac-age-time <10 .. 1000000> (seconds)

For example, to configure the age time to seven minutes:

```
ProCurve(config)# mac-age-time 420
```

Configure the Time Zone and Daylight Time Rule. These commands:

- Set the time zone you want to use
- Define the daylight time rule for keeping the correct time when daylight-saving-time shifts occur.

Syntax: time timezone <-720 .. 840>
time daylight-time-rule <none | alaska | continental-us-and-canada | middle-europe-and-portugal | southern-hemisphere | western-europe | user-defined>

East of the 0 meridian, the sign is “+”. West of the 0 meridian, the sign is “-”.

For example, the time zone setting for Berlin, Germany is +60 (zone +1, or 60 minutes), and the time zone setting for Vancouver, Canada is -480 (zone -8, or -480 minutes). To configure the time zone and daylight time rule for Vancouver, Canada:

```
ProCurve(config)# time timezone -480 daylight-time-rule  
continental-us-and-canada
```

Configure the Time and Date. The switch uses the time command to configure both the time of day and the date. Also, executing time without parameters lists the switch’s time of day and date. Note that the CLI uses a 24-hour clock scheme; that is, hour (*hh*) values from 1 p.m. to midnight are input as 13 - 24, respectively.

Syntax: time [hh:mm[:ss]] [mm/dd/ [yy]yy]

For example, to set the switch to 9:45 a.m. on November 17, 2002:

```
ProCurve(config)# time 9:45 11/17/02
```

Note

Executing **reload** or **boot** resets the time and date to their default startup values.

Web: Configuring System Parameters

In the web browser interface, you can enter the following system information:

- System Name
- System Location
- System Contact

For access to the MAC Age Interval and the Time parameters, use the menu interface or the CLI.

Configure System Parameters in the Web Browser Interface.

1. Click on the **Configuration** tab.
2. Click on **System Info**.
3. Enter the data you want in the displayed fields.
4. Implement your new data by clicking on **Apply Changes**.

To access the web-based help provided for the switch, click on [?] in the web browser screen.

Configuring IP Addressing

Contents

Overview	8-2
IP Configuration	8-3
Just Want a Quick Start with IP Addressing?	8-4
IP Addressing with Multiple VLANs	8-4
IP Addressing in a Stacking Environment	8-5
Menu: Configuring IP Address, Gateway, and Time-To-Live (TTL) ..	8-5
CLI: Configuring IP Address, Gateway, and Time-To-Live (TTL) ...	8-7
Web: Configuring IP Addressing	8-11
How IP Addressing Affects Switch Operation	8-11
DHCP/Bootp Operation	8-12
Network Preparations for Configuring DHCP/Bootp	8-15
IP Preserve: Retaining VLAN-1 IP Addressing Across Configuration	
File Downloads	8-16
Operating Rules for IP Preserve	8-16

Overview

You can configure IP addressing through all of the switch's interfaces. You can also:

- Easily edit a switch configuration file to allow downloading the file to multiple switches without overwriting each switch's unique gateway and VLAN 1 IP addressing.
- Assign up to seven secondary IP addresses to a VLAN (multinetting)

Why Configure IP Addressing? In its factory default configuration, the switch operates as a multiport learning bridge with network connectivity provided by the ports on the switch. However, to enable specific management access and control through your network, you will need IP addressing. Table 8-1 on page 8-12 shows the switch features that depend on IP addressing to operate.

IP Configuration

IP Configuration Features

Feature	Default	Menu	CLI	Web
IP Address and Subnet Mask	DHCP/Bootp	page 8-5	page 8-7	page 8-11
Multiple IP Addresses on a VLAN	n/a		page 8-9	
Default Gateway Address	none	page 8-5	page 8-7	page 8-11
Packet Time-To-Live (TTL)	64 seconds	page 8-5	page 8-7	n/a
Time Server (Timep)	DHCP	page 8-5	page 8-7	n/a

IP Address and Subnet Mask. Configuring the switch with an IP address expands your ability to manage the switch and use its features. By default, the switch is configured to automatically receive IP addressing on the default VLAN from a DHCP/Bootp server that has been configured correctly with information to support the switch. (Refer to “DHCP/Bootp Operation” on page 8-12 for information on setting up automatic configuration from a server.) However, if you are not using a DHCP/Bootp server to configure IP addressing, use the menu interface or the CLI to manually configure the initial IP values. After you have network access to a device, you can use the web browser interface to modify the initial IP configuration if needed.

For information on how IP addressing affects switch performance, refer to “How IP Addressing Affects Switch Operation” on page 8-11.

Multinetting: Assigning Multiple IP Addresses to a VLAN. For a given VLAN you can assign one primary IP address and up to seven secondary IP addresses. This allows you to combine two or more subnets on the same VLAN, which enables devices in the combined subnets to communicate normally through the network without needing to reconfigure the IP addressing in any of the combined subnets.

Default Gateway Operation. The default gateway is required when a router is needed for tasks such as reaching off-subnet destinations or forwarding traffic across multiple VLANs. The gateway value is the IP address of the next-hop gateway node for the switch, which is used if the requested destination address is not on a local subnet/VLAN. If the switch does not have a manually-configured default gateway and DHCP/Bootp is configured on the primary VLAN, then the default gateway value provided by the DHCP or Bootp server will be used. If the switch has a manually configured default gateway,

then the switch uses this gateway, even if a different gateway is received via DHCP or Bootp on the primary VLAN. (This is also true for TimeP and a non-default Time-To-Live.) See “Notes” on page 8-4 and refer to the chapter on Virtual LANs in the *Advanced Traffic Management Guide*.

Packet Time-To-Live (TTL) . This parameter specifies how long in seconds an outgoing packet should exist in the network. In most cases, the default setting (64 seconds) is adequate.

Just Want a Quick Start with IP Addressing?

If you just want to give the switch an IP address so that it can communicate on your network, or if you are not using VLANs, ProCurve recommends that you use the Switch Setup screen to quickly configure IP addressing. To do so, do one of the following:

- Enter **setup** at the CLI Manager level prompt.

```
ProCurve# setup
```

- Select **8. Run Setup** in the Main Menu of the menu interface.

For more on using the Switch Setup screen, see the *Installation and Getting Started Guide* you received with the switch.

IP Addressing with Multiple VLANs

In the factory-default configuration, the switch has one, permanent default VLAN (named DEFAULT_VLAN) that includes all ports on the switch. Thus, when only the default VLAN exists in the switch, if you assign an IP address and subnet mask to the switch, you are actually assigning the IP addressing to the DEFAULT_VLAN.

Notes

- If multiple VLANs are configured, then each VLAN can have its own IP address. This is because each VLAN operates as a separate broadcast domain and requires a unique IP address and subnet mask. A default gateway (IP) address for the switch is optional, but recommended.
- In the factory-default configuration, the default VLAN (named DEFAULT_VLAN) is the switch’s *primary* VLAN. The switch uses the primary VLAN for learning the default gateway address, (packet) Time-To-Live (TTL), and Timep via DHCP or Bootp. (Other VLANs can also use DHCP or BootP to acquire IP addressing. However, the switch’s gateway, TTL, and TimeP values will be acquired through the primary VLAN only.) For more on VLANs, see the *Advanced Traffic Management Guide*.

- The IP addressing used in the switch should be compatible with your network. That is, the IP address must be unique and the subnet mask must be appropriate for your IP network.
 - If you change the IP address through either Telnet access or the web browser interface, the connection to the switch will be lost. You can reconnect by either restarting Telnet with the new IP address or entering the new address as the URL in your web browser.
-

IP Addressing in a Stacking Environment

If you are installing the switch into an ProCurve stack management environment, entering an IP address may not be required. See the chapter on stack management in the *Advanced Traffic Management Guide*.

Menu: Configuring IP Address, Gateway, and Time-To-Live (TTL)

Do one of the following:

- To manually enter an IP address, subnet mask, set the **IP Config** parameter to **Manual** and then manually enter the IP address and subnet mask values you want for the switch.
- To use DHCP or Bootp, use the menu interface to ensure that the **IP Config** parameter is set to **DHCP/Bootp**, then refer to “DHCP/Bootp Operation” on page 8-12.

To Configure IP Addressing.

1. From the Main Menu, Select.
 - 2. Switch Configuration ...**
 - 5. IP Configuration**

Note

If multiple VLANs are configured, a screen showing all VLANs appears instead of the following screen.

For descriptions of these parameters, see the online Help for this screen.

Before using the DHCP/Bootp option, refer to “DHCP/Bootp Operation” on page 8-12.

```
=====-- CONSOLE - MANAGER MODE -----  
Switch Configuration - Internet (IP) Service  
  
Default Gateway :  
Default TTL      : 64  
  
IP Config [DHCP/Bootp] : Manual  
IP Address       : 15.30.248.184  
Subnet Mask      : 255.255.248.0  
  
Actions->  Cancel  Edit  Save  Help  
  
Cancel changes and return to previous screen.  
Use arrow keys to change action selection and <Enter> to execute action.
```

Figure 8-1. Example of the IP Service Configuration Screen without Multiple VLANs Configured

2. Press **[E]** (for **E**dit).
3. If the switch needs to access a router, for example, to reach off-subnet destinations, select the **Default Gateway** field and enter the IP address of the gateway router.
4. If you need to change the packet Time-To-Live (TTL) setting, select **Default TTL** and type in a value between 2 and 255 (seconds).
5. To configure IP addressing, select **IP Config** and do one of the following:
 - If you want to have the switch retrieve its IP configuration from a DHCP or Bootp server, at the **IP Config** field, keep the value as **DHCP/Bootp** and go to step 8.
 - If you want to manually configure the IP information, use the Space bar to select **Manual** and use the **[Tab]** key to move to the other IP configuration fields.
6. Select the **IP Address** field and enter the IP address for the switch.
7. Select the **Subnet Mask** field and enter the subnet mask for the IP address.
8. Press **[Enter]**, then **[S]** (for **S**ave).

CLI: Configuring IP Address, Gateway, and Time-To-Live (TTL)

IP Commands Used in This Section

show ip	page 8-7
vlan <vlan-id> ip address	page 8-8
ip default-gateway	page 8-11
ip ttl	page 8-11

Viewing the Current IP Configuration. The following command displays the IP addressing for each VLAN configured in the switch. If only the DEFAULT_VLAN exists, then its IP configuration applies to all ports in the switch. Where multiple VLANs are configured, the IP addressing is listed per VLAN. The display includes switch-wide packet time-to-live, and (if configured) the switch's default gateway and Timep configuration.

Syntax: show ip

For example, in the factory-default configuration (no IP addressing assigned), the switch's IP addressing appears as:

```
ProCurve> show ip
Internet (IP) Service
  Default Gateway :
  Default TTL     : 64

  TimeP Config : DHCP      TimeP Poll Interval (min) : 720

VLAN          | IP Config | IP Address      Subnet Mask
-----+-----
DEFAULT_VLAN | DHCP/Bootp
```

Figure 8-2. Example of the Switch's Default IP Addressing

With multiple VLANs and some other features configured, **show ip** provides additional information:

```
ProCurve# show ip
Internet (IP) Service
Default Gateway : 10.28.227.1
Default TTL     : 64
VLAN           | IP Config  IP Address      Subnet Mask
-----+-----+-----+-----
DEFAULT_VLAN | Manual    10.28.227.101   255.255.248.0
VLAN_2       | Disabled
```

Figure 8-3. Example of Show IP Listing with Non-Default IP Addressing Configured

Configure an IP Address and Subnet Mask. The following command includes both the IP address and the subnet mask. You must either include the ID of the VLAN for which you are configuring IP addressing or go to the context configuration level for that VLAN. (If you are not using VLANs on the switch—that is, if the only VLAN is the default VLAN—then the VLAN ID is always “1”.)

Note

The default IP address setting for the DEFAULT_VLAN is **DHCP/Bootp**. On additional VLANs you create, the default IP address setting is **Disabled**.

Syntax: `vlan <vlan-id> ip address <ip-address/mask-length>`
 — *or* —
 `vlan <vlan-id> ip address <ip-address> <mask-bits>`
 — *or* —
 `vlan <vlan-id> ip address dhcp-bootp`

This example configures IP addressing on the default VLAN with the subnet mask specified in mask bits.

```
ProCurve(config)# vlan 1 ip address 10.28.227.103/255.255.255.0
```

This example configures the same IP addressing as the preceding example, but specifies the subnet mask by mask length.

```
ProCurve(config)# vlan 1 ip address 10.28.227.103/24
```

Configure Multiple IP Addresses on a VLAN (Multinetting). You can configure one primary IP address per VLAN and up to seven secondary IP addresses for the same VLAN. That is, the switch enables you to assign up to eight networks to a VLAN.

- Each IP address on a VLAN must be for a separate subnet.
- The switch assigns the first IP address manually configured on a VLAN as the primary IP address. The switch then assigns any subsequent IP addresses (for other subnets) manually configured on the VLAN as secondary addresses.
- If the primary IP address on a VLAN is configured for DHCP-Bootp, the switch does not accept secondary IP addresses on that VLAN. (DHCP operates only to provide primary IP addressing, and is not used for providing secondary IP addressing.)
- The switch allows up to 512 secondary subnet address assignments to VLANs.

Syntax: [no] vlan <vlan-id> ip address <ip-address/mask-length>
[no] vlan <vlan-id> ip address <ip-address> <mask-bits>

For example, if you wanted to multinet VLAN_20 (VID = 20) with its primary IP address and two secondary IP addresses shown below, you would perform steps similar to the following. (For this example, assume that the primary IP addressing is already configured.)

Status	VID	IP Address	Subnet Mask
Primary	20	10.25.33.101	255.255.240.0
Secondary	20	10.26.33.101	255.255.240.0
Secondary	20	10.27.33.101	255.255.240.0

1. Go to VLAN 20.
2. Configure two secondary IP addresses on VLAN 20.
3. Display IP addressing.

```

ProCurve(config)# vlan 20
ProCurve(vlan-20)# ip address 10.26.33.101/20
ProCurve(vlan-20)# ip address 10.27.33.101/20
ProCurve(vlan-20)# show ip
Internet (IP) Service

IP Routing : Disabled

Default Gateway :
Default TTL   : 64

VLAN          | IP Config | IP Address | Subnet Mask
-----+-----+-----+-----
DEFAULT_VLAN | Manual   | 10.20.30.100 | 255.255.240.0
VLAN_20      | Manual   | 10.25.33.101 | 255.255.240.0
              | Manual   | 10.26.33.101 | 255.255.240.0
              | Manual   | 10.27.33.101 | 255.255.240.0

```

Note: A VLAN's secondary IP entries are listed below the VLAN's name and primary IP address.

In a **show ip** listing, the first IP address listed for a VLAN is always that VLAN's primary IP address.

Figure 8-4. Example of Configuring and Displaying a Multinetted VLAN

If you then wanted to multinet the default VLAN, you would do the following:

```
ProCurve(vlan-20)# vlan 1
ProCurve(vlan-1)# ip address 10.21.30.100/20
ProCurve(vlan-1)# show ip
```

Internet (IP) Service

IP Routing : Disabled

Default Gateway :

Default TTL : 64

VLAN	IP Config	IP Address	Subnet Mask
DEFAULT_VLAN	Manual	10.20.30.100	255.255.240.0
	Manual	10.21.30.100	255.255.240.0
VLAN_20	Manual	10.25.33.101	255.255.240.0
	Manual	10.26.33.101	255.255.240.0
	Manual	10.27.33.101	255.255.240.0

The secondary IP addresses in a VLAN are listed immediately after the primary IP address for the VLAN.

Figure 8-5. Example of Multinetting on the Default VLAN

Note

The Internet (IP) Service screen in the Menu interface (figure 8-1 on page 8-6) displays only the primary IP address for each VLAN. You must use the CLI **show ip** command to display the full IP address listing for multinetted VLANs.

Removing or Replacing IP Addresses in a Subnetted VLAN. To remove an IP address from a subnetted VLAN, use the “no” form of the IP address command shown on page 8-9. Generally, to replace one IP address with another, you should first remove the address you want to replace, and then enter the new address. However, in a subnetted VLAN, if you remove the primary IP address from a VLAN, the next sequential secondary IP address becomes the primary address. If you later re-enter the former primary IP address, the switch configures it as a secondary address. Thus, if you need to change the primary IP address in a subnetted VLAN, you must remove the secondary IP addresses configured for that VLAN before you replace the primary address.

Configure the Optional Default Gateway. Using the Global configuration level, you can assign one default gateway to the switch.

Syntax: `ip default-gateway <ip-address>`

For example:

```
ProCurve(config)# ip default-gateway 10.28.227.115
```

Configure Time-To-Live (TTL). Use this command at the Global config prompt to set the time that a packet outbound from the switch can exist on the network. The default setting is 64 seconds.

Syntax: `ip ttl <number-of-seconds>`

```
ProCurve(config)# ip ttl 60
```

In the CLI, you can execute this command only from the global configuration level. The TTL range is 2 - 255 seconds.

Web: Configuring IP Addressing

You can use the web browser interface to access IP addressing only if the switch already has an IP address that is reachable through your network.

1. Click on the **Configuration** tab.
2. Click on [**IP Configuration**].
3. If you need further information on using the web browser interface, click on [?] to access the web-based help available for the switch.

How IP Addressing Affects Switch Operation

Without an IP address and subnet mask compatible with your network, the switch can be managed only through a direct terminal device connection to the Console RS-232 port. You can use direct-connect console access to take advantage of features that do not depend on IP addressing. However, to realize the full performance capabilities ProCurve proactive networking offers through the switch, configure the switch with an IP address and subnet mask compatible with your network. The following table lists the general features available with and without a network-compatible IP address configured.

Table 8-1. Features Available With and Without IP Addressing on the Switch

Features Available Without an IP Address	Additional Features Available with an IP Address and Subnet Mask
<ul style="list-style-type: none">• Direct-connect access to the CLI and the menu interface.• Stacking Candidate or Stack Member• DHCP or Bootp support for automatic IP address configuration, and DHCP support for automatic Timep server IP address configuration• Spanning Tree Protocol• Port settings and port trunking• Console-based status and counters information for monitoring switch operation and diagnosing problems through the CLI or menu interface.• VLANs and GVRP• Serial downloads of operating system (OS) updates and configuration files (Xmodem)• Link test• Port monitoring• Password authentication• Quality of Service• Authorized IP manager	<ul style="list-style-type: none">• Web browser interface access, with configuration, security, and diagnostic tools, plus the Alert Log for discovering problems detected in the switch along with suggested solutions• SNMP network management access such as ProCurve Manager network configuration, monitoring, problem-finding and reporting, analysis, and recommendations for changes to increase control and uptime• TACACS+, RADIUS, SSH, SSL, and 802.1X authentication• Multinetting on VLANs• Stacking Commander*• Telnet access to the CLI or the menu interface• IGMP• Timep server configuration• TFTP download of configurations and OS updates• Ping test
<p>*Although a Commander can operate without an IP address, doing so makes it unavailable for in-band access in an IP network.</p>	

DHCP/Bootp Operation

Overview. DHCP/Bootp is used to provide configuration data from a DHCP or Bootp server to the switch. This data can be the IP address, subnet mask, default gateway, Timep Server address, and TFTP server address. If a TFTP server address is provided, this allows the switch to TFTP a previously saved configuration file from the TFTP server to the switch. With either DHCP or Bootp, the servers must be configured prior to the switch being connected to the network.

The DHCP/Bootp Process. Whenever the **IP Config** parameter in the switch or in an individual VLAN in the switch is configured to **DHCP/Bootp** (the default), or when the switch is rebooted with this configuration:

1. DHCP/Bootp requests are automatically broadcast on the local network. (The switch sends one type of request to which either a DHCP or Bootp server can respond.)

2. When a DHCP or Bootp server receives the request, it replies with a previously configured IP address and subnet mask for the switch. The switch also receives an IP Gateway address if the server has been configured to provide one. In the case of Bootp, the server must first be configured with an entry that has the MAC address of the switch. (To determine the switch's MAC address, see Appendix D, "MAC Address Management". The switch properly handles replies from either type of server. If multiple replies are returned, the switch will use the first reply.)

Note

If you manually configure a gateway on the switch, it will ignore any gateway address received via DHCP or Bootp.

If the switch is initially configured for DHCP/Bootp operation (the default), or if it is rebooted with this configuration, it immediately begins sending request packets on the network. If the switch does not receive a reply to its DHCP/Bootp requests, it continues to periodically send request packets, but with decreasing frequency. Thus, if a DHCP or Bootp server is not available or accessible to the switch when DHCP/Bootp is first configured, the switch may not immediately receive the desired configuration. After verifying that the server has become accessible to the switch, reboot the switch to re-start the process immediately.

DHCP Operation. Depending on how the DHCP server is configured, the switch may receive an IP address that is temporarily leased. Periodically the switch may be required to renew its lease of the IP configuration. Thus, the IP addressing provided by the server may be different each time the switch reboots or renews its configuration from the server. However, you can fix the address assignment for the switch by doing either of the following:

- Configure the server to issue an "infinite" lease.
- Using the switch's MAC address as an identifier, configure the server with a "Reservation" so that it will always assign the same IP address to the switch. (For MAC address information, refer to Appendix D, "MAC Address Management".)

For more information on either of these procedures, refer to the documentation provided with the DHCP server.

Bootp Operation. When a Bootp server receives a request it searches its Bootp database for a record entry that matches the MAC address in the Bootp request from the switch. If a match is found, the configuration data in the associated database record is returned to the switch. For many Unix systems, the Bootp database is contained in the `/etc/bootptab` file. In contrast to DHCP

operation, Bootp configurations are always the same for a specific receiving device. That is, the Bootp server replies to a request with a configuration previously stored in the server and designated for the requesting device.

Bootp Database Record Entries. A minimal entry in the Bootp table file `/etc/bootptab` to update an IP address and subnet mask to the switch or a VLAN configured in the switch would be similar to this entry:

```
j2810switch:\
ht=ether:\
ha=0030c1123456:\
ip=10.66.77.88:\
sm=255.255.248.0:\
gw=10.66.77.1:\
hn:\
vm=rfc1048
```

An entry in the Bootp table file `/etc/bootptab` to tell the switch or VLAN where to obtain a configuration file download would be similar to this entry:

```
j2810switch:\
ht=ether:\
ha=0030c1123456:\
ip=10.66.77.88:\
sm=255.255.248.0:\
gw=10.66.77.1:\
lg=10.22.33.44:\
T144="switch.cfg":\
vm=rfc1048
```

where:

j2810switch	is a user-defined symbolic name to help you find the correct section of the bootptab file. If you have multiple switches that will be using Bootp to get their IP configuration, you should use a unique symbolic name for each switch.
ht	is the "hardware type". For the switches covered in this guide, set this to ether (for Ethernet). <i>This tag must precede the ha tag.</i>
ha	is the "hardware address". Use the switch's (or VLAN's) 12-digit MAC address.
ip	is the IP address to be assigned to the switch (or VLAN).
sm	is the subnet mask of the subnet in which the switch (or VLAN) is installed.
gw	is the IP address of the default gateway.
lg	TFTP server address (source of final configuration file)
T144	is the vendor-specific "tag" identifying the configuration file to download.
vm	is a required entry that specifies the Bootp report format. For the switches described in this guide, set this parameter to rfc1048 .

Note

The above Bootp table entry is a sample that will work for the switch when the appropriate addresses and file names are used.

Network Preparations for Configuring DHCP/Bootp

In its default configuration, the switch is configured for DHCP/Bootp operation. However, the DHCP/Bootp feature will not acquire IP addressing for the switch unless the following tasks have already been completed:

- For Bootp operation:
 - A Bootp database record has already been entered into an appropriate Bootp server.
 - The necessary network connections are in place
 - The Bootp server is accessible from the switch
- For DHCP operation:
 - A DHCP scope has been configured on the appropriate DHCP server.
 - The necessary network connections are in place
 - A DHCP server is accessible from the switch

Note

Designating a primary VLAN other than the default VLAN affects the switch's use of information received via DHCP/Bootp. For more on this topic, see the chapter on Virtual LANs in the *Advanced Traffic Management Guide*.

After you reconfigure or reboot the switch with DHCP/Bootp enabled in a network providing DHCP/Bootp service, the switch does the following:

- Receives an IP address and subnet mask and, if configured in the server, a gateway IP address and the address of a Timep server.
- If the DHCP/Bootp reply provides information for downloading a configuration file, the switch uses TFTP to download the file from the designated source, then reboots itself. (This assumes that the switch or VLAN has connectivity to the TFTP file server specified in the reply, that the configuration file is correctly named, and that the configuration file exists in the TFTP directory.)

IP Preserve: Retaining VLAN-1 IP Addressing Across Configuration File Downloads

IP Preserve enables you to copy a configuration file to multiple switches that use the same operating-system software while retaining the individual IP address and subnet mask on VLAN 1 in each switch, and the Gateway IP address assigned to the switch. This enables you to distribute the same configuration file to multiple switches without overwriting their individual IP addresses.

Operating Rules for IP Preserve

When **ip preserve** is entered as the last line in a configuration file stored on a TFTP server:

- If the switch's current IP address for VLAN 1 was not configured by DHCP/Bootp, IP Preserve retains the switch's current IP address, subnet mask, and IP gateway address when the switch downloads the file and reboots. The switch adopts all other configuration parameters in the configuration file into the startup-config file.
- If the switch's current IP addressing for VLAN 1 is from a DHCP server, IP Preserve is suspended. In this case, whatever IP addressing the configuration file specifies is implemented when the switch downloads the file and reboots. If the file includes DHCP/Bootp as the IP addressing source for VLAN 1, the switch will configure itself accordingly and use DHCP/Bootp. If instead, the file includes a dedicated IP address and subnet mask for VLAN 1 and a specific gateway IP address, then the switch will implement these settings in the startup-config file.
- The **ip preserve** statement does not appear in **show config** listings. To verify IP Preserve in a configuration file, open the file in a text editor and view the last line. For an example of implementing IP Preserve in a configuration file, see figure 8-6, below.

To set up IP Preserve, enter the **ip preserve** statement at the end of a configuration file. (Note that you do not execute IP Preserve by entering a command from the CLI).

```

; J9022A Configuration Editor; Created on release #N.10.XX
hostname "ProCurve Switch"
time daylight-time-rule None
.
.
.
password manager
Password operator
ip preserve
    
```

Entering "ip preserve" in the last line of a configuration file implements IP Preserve when the file is downloaded to the switch and the switch reboots.

Figure 8-6. Example of Implementing IP Preserve in a Switch Configuration File

For example, consider Figure 8-7:

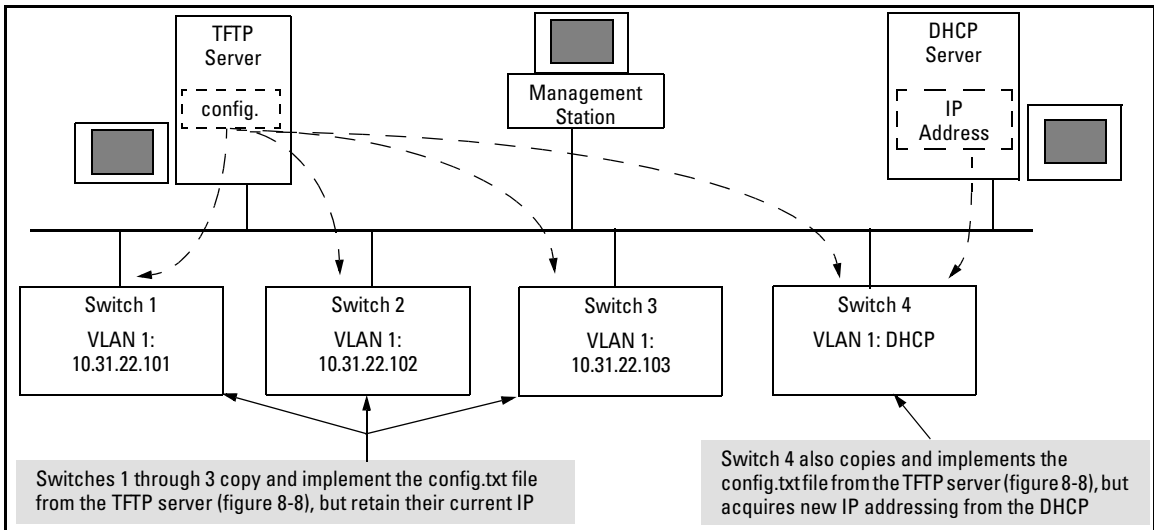

Figure 8-7. Example of IP Preserve Operation with Multiple Switches Using the Same OS Software

If you apply the following configuration file to figure 8-7, switches 1 - 3 will retain their manually assigned IP addressing and switch 4 will be configured to acquire its IP addressing from a DHCP server.

Configuring IP Addressing

IP Preserve: Retaining VLAN-1 IP Addressing Across Configuration File Downloads

```
; J9022A Configuration Editor; Created on release #N.10.XX
hostname "ProCurve Switch"
time daylight-time-rule None
interface 11
  no lacp
interface 12
  no lacp
exit
trunk 11-12 Trk1 Trunk
ip default-gateway 10.22.32.1
snmp-server community "public" Unrestricted
vlan 1
  name "DEFAULT VLAN"
  ip address dhcp-bootp
  exit
password manager
Password operator
ip preserve
```

Using figure 8-7, above, switches 1 - 3 ignore these entries because the file implements IP Preserve and their current IP addressing was not acquired through DHCP/Bootp.

Switch 4 ignores IP Preserve and implements the DHCP/Bootp addressing and IP Gateway specified in this file (because its last IP addressing was acquired from a DHCP/Bootp server).

IP Preserve Command

Figure 8-8. Configuration File in TFTP Server, with DHCP/Bootp Specified as the IP Addressing Source

If you apply this configuration file to figure 8-7, switches 1 - 3 will still retain their manually assigned IP addressing. However, switch 4 will be configured with the IP addressing included in the file.

```
; J9022A Configuration Editor; Created on release #N.10.XX
hostname "ProCurve Switch"
time daylight-time-rule None
interface 11
  no lacp
interface 12
  no lacp
exit
trunk 11-12 Trk1 Trunk
ip default-gateway 10.22.32.1
snmp-server community "public" Unrestricted
vlan 1
  name "DEFAULT VLAN"
  forbid 3
  untagged 1,7-10,13-14,Trk1
  tagged 4-6
  no untagged 2-3
  ip address 10.31.22.255 255.255.249.0
  exit
password manager
Password operator
ip preserve
```

Because switch 4 (figure 8-7) received its most recent IP addressing from a DHCP/Bootp server, the switch ignores the **ip preserve** command and implements the IP addressing included in this file.

Figure 8-9. Configuration File in TFTP Server, with Dedicated IP Addressing Instead of DHCP/Bootp

To summarize the IP Preserve effect on IP addressing:

- If the switch received its most recent VLAN 1 IP addressing from a DHCP/Bootp server, it ignores the IP Preserve command when it downloads the configuration file, and implements whatever IP addressing instructions are in the configuration file.
- If the switch did not receive its most recent VLAN 1 IP addressing from a DHCP/Bootp server, it retains its current IP addressing when it downloads the configuration file.
- The content of the downloaded configuration file determines the IP addresses and subnet masks for other VLANs.

Configuring IP Addressing

IP Preserve: Retaining VLAN-1 IP Addressing Across Configuration File Downloads

Time Protocols

Contents

Overview	9-2
TimeP Time Synchronization	9-2
SNTP Time Synchronization	9-2
Overview: Selecting a Time Synchronization Protocol or Turning Off Time Protocol Operation	9-3
General Steps for Running a Time Protocol on the Switch	9-3
Disabling Time Synchronization	9-3
SNTP: Viewing, Selecting, and Configuring	9-4
Menu: Viewing and Configuring SNTP	9-5
CLI: Viewing and Configuring SNTP	9-8
Viewing the Current SNTP Configuration	9-8
Configuring (Enabling or Disabling) the SNTP Mode	9-9
TimeP: Viewing, Selecting, and Configuring	9-14
Menu: Viewing and Configuring TimeP	9-15
CLI: Viewing and Configuring TimeP	9-16
Viewing the Current TimeP Configuration	9-17
Configuring (Enabling or Disabling) the TimeP Mode	9-18
SNTP Unicast Time Polling with Multiple SNTP Servers	9-21
Address Prioritization	9-21
Adding and Deleting SNTP Server Addresses	9-22
Menu Interface Operation with Multiple SNTP Server Addresses Configured	9-23
SNTP Messages in the Event Log	9-24

Overview

This chapter describes:

- SNTP Time Protocol Operation
- Timep Time Protocol Operation

Using time synchronization ensures a uniform time among inter operating devices. This helps you to manage and troubleshoot switch operation by attaching meaningful time data to event and error messages.

The switch offers TimeP and SNTP (Simple Network Time Protocol) and a **timesync** command for changing the time protocol selection (or turning off time protocol operation).

Notes

Although you can create and save configurations for both time protocols without conflicts, the switch allows only one active time protocol at any time.

In the factory-default configuration, the time synchronization option is set to TimeP, with the TimeP mode itself set to **Disabled**.

TimeP Time Synchronization

You can either manually assign the switch to use a TimeP server or use DHCP to assign the TimeP server. In either case, the switch can get its time synchronization updates from only one, designated Timep server. This option enhances security by specifying which time server to use.

SNTP Time Synchronization

SNTP provides two operating modes:

- **Broadcast Mode:** The switch acquires time updates by accepting the time value from the first SNTP time broadcast detected. (In this case, the SNTP server must be configured to broadcast time updates to the network broadcast address. Refer to the documentation provided with your SNTP server application.) Once the switch detects a particular server, it ignores time broadcasts from other SNTP servers unless the configurable **Poll Interval** expires three consecutive times without an update received from the first-detected server.

Note

To use Broadcast mode, the switch and the SNTP server must be in the same subnet.

- **Unicast Mode:** The switch requests a time update from the configured SNTP server. (You can configure one server using the menu interface, or up to three servers using the CLI **sntp server** command.) This option provides increased security over the Broadcast mode by specifying which time server to use instead of using the first one detected through a broadcast.

Overview: Selecting a Time Synchronization Protocol or Turning Off Time Protocol Operation

General Steps for Running a Time Protocol on the Switch

1. Select the time synchronization protocol: **SNTP** or **TimeP** (the default).
2. Enable the protocol. The choices are:
 - SNTP: **Broadcast** or **Unicast**
 - TimeP: **DHCP** or **Manual**
3. Configure the remaining parameters for the time protocol you selected.

The switch retains the parameter settings for both time protocols even if you change from one protocol to the other. Thus, if you select a time protocol, the switch uses the parameters you last configured for the selected protocol.

Note that simply selecting a time synchronization protocol does not enable that protocol on the switch unless you also enable the protocol itself (step 2, above). For example, in the factory-default configuration, TimeP is the selected time synchronization method. However, because TimeP is disabled in the factory-default configuration, no time synchronization protocol is running.

Disabling Time Synchronization

You can use either of the following methods to disable time synchronization without changing the Timep or SNTP configuration:

Time Protocols

SNTP: Viewing, Selecting, and Configuring

- In the System Information screen of the Menu interface, set the **Time Synch Method** parameter to **None**, then press **[Enter]**, then **[S]** (for **Save**).
- In the Global config level of the CLI, execute **no timesync**.

SNTP: Viewing, Selecting, and Configuring

SNTP Feature	Default	Menu	CLI	Web
view the SNTP time synchronization configuration	n/a	page 9-5	page 9-8	—
select SNTP as the time synchronization method	timep	page 9-6	page 9-9 ff.	—
disable time synchronization	timep	page 9-6	page 9-12	—
enable the SNTP mode (Broadcast, Unicast, or Disabled)	disabled			—
broadcast	n/a	page 9-6	page 9-9	—
unicast	n/a	page 9-6	page 9-10	—
none/disabled	n/a	page 9-6	page 9-13	—
configure an SNTP server address (for Unicast mode only)	none	page 9-6	page 9-10 ff.	—
change the SNTP server version (for Unicast mode only)	3	page 9-7	page 9-12	—
change the SNTP poll interval	720 seconds	page 9-7	page 9-12	—

Table 9-1.SNTP Parameters

SNTP Parameter	Operation
Time Sync Method	Used to select either SNTP, TIMEP, or None as the time synchronization method.
SNTP Mode	
Disabled	The Default. SNTP does not operate, even if specified by the Menu interface Time Sync Method parameter or the CLI timesync command.
Unicast	Directs the switch to poll a specific server for SNTP time synchronization. Requires at least one server address.
Broadcast	Directs the switch to acquire its time synchronization from data broadcast by any SNTP server to the network broadcast address. The switch uses the first server detected and ignores any others. However, if the Poll Interval expires three times without the switch detecting a time update from the original server, it the switch accepts a broadcast time update from the next server it detects.
Poll Interval (seconds)	In Unicast Mode: Specifies how often the switch polls the designated SNTP server for a time update. In Broadcast Mode: Specifies how often the switch polls the network broadcast address for a time update.
Server Address	Used only when the SNTP Mode is set to Unicast . Specifies the IP address of the SNTP server that the switch accesses for time synchronization updates. You can configure up to three servers; one using the menu or CLI, and two more using the CLI. See “SNTP Unicast Time Polling with Multiple SNTP Servers” on page 9-21.
Server Version	Default: 3; range: 1 - 7. Specifies the SNTP software version to use, and is assigned on a per-server basis. The version setting is backwards-compatible. For example, using version 3 means that the switch accepts versions 1 through 3.

Menu: Viewing and Configuring SNTP

To View, Enable, and Modify SNTP Time Protocol:

1. From the Main Menu, select:
 - 2. Switch Configuration...**
 - 1. System Information**

Time Protocols

SNTP: Viewing, Selecting, and Configuring

```
=====-- CONSOLE - MANAGER MODE -----=====
                          Switch Configuration - System Information

System Name : ProCurve switch
System Contact :
System Location :

Inactivity Timeout (min) [0] : 0      MAC Age Time(sec) [300] : 300
Inbound Telnet Enabled [Yes] : Yes    Web Agent Enabled [Yes] : Yes

Time Sync Method [TIMEP]: TIMEP ← Time Protocol Selection Parameter
TimeP Mode [Disabled] : Disabled      - TIMEP
                                       - SNTP
                                       - None

Time Zone [0] : 0
Daylight Time Rule [None] : None

Actions->  Cancel      Edit      Save      Help

Cancel changes and return to previous screen.
Use arrow keys to change action selection and <Enter> to execute action.
```

Figure 9-1. The System Information Screen (Default Values)

2. Press **[E]** (for **E**dit). The cursor moves to the **System Name** field.
3. Use **[↓]** to move the cursor to the **Time Sync Method** field.
4. Use the Space bar to select **SNTP**, then press **[↓]** once to display and move to the **SNTP Mode** field.
5. Do one of the following:
 - Use the Space bar to select the **Broadcast** mode, then press **[↓]** to move the cursor to the **Poll Interval** field, and go to step 6. (For Broadcast mode details, see “SNTP Operating Modes” on page 9-2.)

```
Time Sync Method [None] : SNTP
SNTP Mode [Disabled] : Broadcast
Poll Interval (sec) [720] : 720
Time Zone [0] : 0
Daylight Time Rule [None] : None
```

- Use the Space bar to select the **Unicast** mode, then do the following:
 - i. Press **[→]** to move the cursor to the **Server Address** field.

- ii. Enter the IP address of the SNTP server you want the switch to use for time synchronization.

Note: This step replaces any previously configured server IP address. If you will be using backup SNTP servers (requires use of the CLI), then see “SNTP Unicast Time Polling with Multiple SNTP Servers” on page 9-21.

- iii. Press to move the cursor to the **Server Version** field. Enter the value that matches the SNTP server version running on the device you specified in the preceding step (step ii). If you are unsure which version to use, ProCurve recommends leaving this value at the default setting of **3** and testing SNTP operation to determine whether any change is necessary.

Note: Using the menu to enter the IP address for an SNTP server when the switch already has one or more SNTP servers configured causes the switch to delete the primary SNTP server from the server list and to select a new primary SNTP server from the IP address(es) in the updated list. For more on this topic, see “SNTP Unicast Time Polling with Multiple SNTP Servers” on page 9-21.

- iv. Press to move the cursor to the **Poll Interval** field, then go to step 6.

```
Time Sync Method [None] : SNTP
SNTP Mode [Disabled] : Unicast      Server Address : 10.28.227.15
Poll Interval (sec) [720] : 720     Server Version [3] : 3
Time Zone [0] : 0
Daylight Time Rule [None] : None
```

6. In the **Poll Interval** field, enter the time in seconds that you want for a Poll Interval. (For Poll Interval operation, see table 9-1, “SNTP Parameters”, on page 9-5.)
7. Press **[Enter]** to return to the Actions line, then **[S]** (for **Save**) to enter the new time protocol configuration in both the startup-config and running-config files.

CLI: Viewing and Configuring SNTP

CLI Commands Described in this Section

show sntp	page 9-8
[no] timesync	pages 9-9 and ff., 9-12
sntp broadcast	page 9-9
sntp unicast	page 9-10
sntp server	pages 9-10 and ff.
Protocol Version	page 9-12
poll-interval	page 9-12
no sntp	page 9-13

This section describes how to use the CLI to view, enable, and configure SNTP parameters.

Viewing the Current SNTP Configuration

This command lists both the time synchronization method (**TimeP**, **SNTP**, or **None**) and the SNTP configuration, even if SNTP is not the selected time protocol.

Syntax: show sntp

For example, if you configured the switch with SNTP as the time synchronization method, then enabled SNTP in broadcast mode with the default poll interval, **show sntp** lists the following:

```
ProCurve# show sntp
SNTP Configuration
  Time Sync Mode: Sntp
  SNTP Mode : Broadcast
  Poll Interval (sec) [720] : 720
```

Figure 9-2. Example of SNTP Configuration When SNTP Is the Selected Time Synchronization Method

In the factory-default configuration (where TimeP is the selected time synchronization method), **show sntp** still lists the SNTP configuration even though it is not currently in use. For example:

```
ProCurve# show sntp
SNTP Configuration
Time Sync Mode: Timep
SNTP Mode : Broadcast
Poll Interval (sec) [720] : 720
```

Even though, in this example, TimeP is the current time synchronous method, the switch maintains the SNTP configuration.

Figure 9-3. Example of SNTP Configuration When SNTP Is Not the Selected Time Synchronization Method

Configuring (Enabling or Disabling) the SNTP Mode

Enabling the SNTP mode means to configure it for either broadcast or unicast mode. Remember that to run SNTP as the switch's time synchronization protocol, you must also select SNTP as the time synchronization method by using the CLI **timesync** command (or the Menu interface **Time Sync Method** parameter).

- Syntax:** `timesync sntp`
Selects SNTP as the time protocol.
- `sntp < broadcast | unicast >`
Enables the SNTP mode (below and page 9-10).
- `sntp server < ip-addr >`
Required only for unicast mode (page 9-10).
- `sntp poll-interval < 30 . . 720 >`
Enabling the SNTP mode also enables the SNTP poll interval (default: 720 seconds; page 9-12).

Enabling SNTP in Broadcast Mode. Because the switch provides an SNTP polling interval (default: 720 seconds), you need only these two commands for minimal SNTP broadcast configuration:

- Syntax:** `timesync sntp`
Selects SNTP as the time synchronization method.
- `sntp broadcast`
*Configures **Broadcast** as the SNTP mode.*

For example, suppose:

- Time synchronization is in the factory-default configuration (TimeP is the currently selected time synchronization method).
- You want to:
 1. View the current time synchronization.

Time Protocols

SNTP: Viewing, Selecting, and Configuring

2. Select SNTP as the time synchronization mode.
3. Enable SNTP for Broadcast mode.
4. View the SNTP configuration again to verify the configuration.

The commands and output would appear as follows:

```
ProCurve(config)# show sntp 1 show sntp displays the SNTP configuration and also shows that
SNTP Configuration                                     TimeP is the currently active time synchronization mode.
  Time Sync Mode: Timep
  SNTP Mode : disabled
  Poll Interval (sec) [720] : 720
ProCurve(config)# timesync sntp 2
ProCurve(config)# sntp broadcast 3
ProCurve(config)# show sntp 4 show sntp again displays the SNTP configuration and shows that
SNTP Configuration                                     SNTP is now the currently active time synchronization mode and is
  Time Sync Mode: Sntp                                 configured for broadcast operation.
  SNTP Mode : Broadcast
  Poll Interval (sec) [720] : 720
```

Figure 9-4. Example of Enabling SNTP Operation in Broadcast Mode

Enabling SNTP in Unicast Mode. Like broadcast mode, configuring SNTP for unicast mode enables SNTP. However, for Unicast operation, you must also specify the IP address of at least one SNTP server. The switch allows up to three unicast servers. You can use the Menu interface or the CLI to configure one server or to replace an existing Unicast server with another. To add a second or third server, you must use the CLI. For more on SNTP operation with multiple servers, see “SNTP Unicast Time Polling with Multiple SNTP Servers” on page 9-21.

Syntax: timesync sntp
Selects SNTP as the time synchronization method.

sntp unicast
Configures the SNTP mode for Unicast operation.

sntp server <ip-addr> [version]
Specifies the SNTP server. The default server version is 3.

no sntp server <ip-addr>
Deletes the specified SNTP server.

Note

Deleting an SNTP server when only one is configured disables SNTP unicast operation.

For example, to select SNTP and configure it with unicast mode and an SNTP server at 10.28.227.141 with the default server version (3) and default poll interval (720 seconds):

```
ProCurve(config)# timesync sntp  
Selects SNTP.
```

```
ProCurve(config)# sntp unicast  
Activates SNTP in Unicast mode.
```

```
ProCurve(config)# sntp server 10.28.227.141  
Specifies the SNTP server and accepts the current SNTP server  
version (default: 3).
```

```
ProCurve(config)# show sntp  
SNTP Configuration  
Time Sync Mode: Sntp  
SNTP Mode : Unicast  
Poll Interval (sec) [720] : 720  
IP Address          Protocol Version  
-----  
10.28.227.141     3
```

In this example, the **Poll Interval** and the **Protocol Version** appear at their default settings.

Note: Protocol Version appears only when there is an IP address configured for an SNTP server.

Figure 9-5. Example of Configuring SNTP for Unicast Operation

If the SNTP server you specify uses SNTP version 4 or later, use the **sntp server** command to specify the correct version number. For example, suppose you learned that SNTP version 4 was in use on the server you specified above (IP address 10.28.227.141). You would use the following commands to delete the server IP address and then re-enter it with the correct version number for that server:

Time Protocols

SNTP: Viewing, Selecting, and Configuring

```
ProCurve(config)# no sntp server 10.28.227.141
ProCurve(config)# sntp server 10.28.227.141 4
ProCurve(config)# show sntp
SNTP Configuration
  Time Sync Mode: Sntp
  SNTP Mode : Broadcast
  Poll Interval (sec) [720] : 600
  IP Address      Protocol Version
  -----
  10.28.227.141  4
```

Deletes unicast SNTP server entry.

Re-enters the unicast server with a non-default protocol version.

show sntp displays the result.

Figure 9-6. Example of Specifying the SNTP Protocol Version Number

Changing the SNTP Poll Interval.

Syntax: `sntp poll-interval < 30 .. 720 >`
Specifies how long the switch waits between time polling intervals. The default is 720 seconds and the range is 30 to 720 seconds. (This parameter is separate from the poll interval parameter used for Timep operation.)

For example, to change the poll interval to 300 seconds:

```
ProCurve(config)# sntp poll-interval 300
```

Disabling Time Synchronization Without Changing the SNTP Configuration. The recommended method for disabling time synchronization is to use the **timesync** command to avoid changing the switch's SNTP configuration.

Syntax: `no timesync`
Halts time synchronization without changing the switch's SNTP configuration

For example, suppose SNTP is running as the switch's time synchronization protocol, with **Broadcast** as the SNTP mode and the factory-default polling interval. You would halt time synchronization with this command:

```
ProCurve(config)# no timesync
```

If you then viewed the SNTP configuration, you would see the following:

```
ProCurve(config)# show sntp
SNTP Configuration
  Time Sync Mode: Disabled
  SNTP Mode : Broadcast
  Poll Interval (sec) [720] : 720
```

Figure 9-7. Example of SNTP with Time Synchronization Disabled

Disabling the SNTP Mode. If you want to prevent SNTP from being used even if selected by **timesync** (or the Menu interface's **Time Sync Method** parameter), configure the SNTP mode as disabled.

Syntax: no sntp
*Disables SNTP by changing the SNTP mode configuration to **Disabled**.*

For example, if the switch is running SNTP in Unicast mode with an SNTP server at 10.28.227.141 and a server version of 3 (the default), **no sntp** changes the SNTP configuration as shown below, and disables time synchronization on the switch.

```
ProCurve(config)# no sntp
ProCurve(config)# show sntp
SNTP Configuration
  Time Sync Mode: Sntp
  SNTP Mode : disabled
  Poll Interval (sec) [720] : 720
IP Address          Protocol Version
-----
10.28.227.141      3
```

Even though the **Time Sync Mode** is set to **Sntp**, time synchronization is disabled because **no sntp** has disabled the **SNTP Mode** parameter.

Figure 9-8. Example of Disabling Time Synchronization by Disabling the SNTP Mode

TimeP: Viewing, Selecting, and Configuring

TimeP Feature	Default	Menu	CLI	Web
view the Timep time synchronization configuration	n/a	page 9-15	page 9-17	—
select Timep as the time synchronization method	TIMEP	page 9-13	pages 9-18 ff.	—
disable time synchronization	timep	page 9-15	page 9-20	—
enable the Timep mode	Disabled			—
DHCP	—	page 9-15	page 9-18	—
manual	—	page 9-16	page 9-19	—
none/disabled	—	page 9-15	page 9-21	—
change the SNTP poll interval	720 seconds	page 9-16	page 9-20	—

Table 9-2. Timep Parameters

SNTP Parameter	Operation
Time Sync Method	Used to select either TIMEP (the default), SNTP, or None as the time synchronization method.
Timep Mode	
Disabled	The Default. Timep does not operate, even if specified by the Menu interface Time Sync Method parameter or the CLI timesync command.
DHCP	When Timep is selected as the time synchronization method, the switch attempts to acquire a Timep server IP address via DHCP. If the switch receives a server address, it polls the server for updates according to the Timep poll interval. If the switch does not receive a Timep server IP address, it cannot perform time synchronization updates.
Manual	When Timep is selected as the time synchronization method, the switch attempts to poll the specified server for updates according to the Timep poll interval. If the switch fails to receive updates from the server, time synchronization updates do not occur.
Server Address	Used only when the TimeP Mode is set to Manual . Specifies the IP address of the TimeP server that the switch accesses for time synchronization updates. You can configure one server.
Poll Interval (minutes)	Default: 720 minutes. Specifies the interval the switch waits between attempts to poll the TimeP server for updates.

Menu: Viewing and Configuring TimeP

To View, Enable, and Modify the TimeP Protocol:

1. From the Main Menu, select:
 2. **Switch Configuration...**
 1. **System Information**

```
===== CONSOLE - MANAGER MODE =====
Switch Configuration - System Information

System Name : ProCurve switch
System Contact :
System Location :

Inactivity Timeout (min) [0] : 0      MAC Age Time(sec) [300] : 300
Inbound Telnet Enabled [Yes] : Yes    Web Agent Enabled [Yes] : Yes

Time Sync Method [TIMEP]: TIMEP ← Time Protocol Selection Parameter
TimeP Mode [Disabled] : Disabled      - TIMEP (the default)
                                       - SNTP
                                       - None

Time Zone [0] : 0
Daylight Time Rule [None] : None

Actions->  Cancel  Edit  Save  Help

Cancel changes and return to previous screen.
Use arrow keys to change action selection and <Enter> to execute action.
```

Figure 9-9. The System Information Screen (Default Values)

2. Press [E] (for **Edit**). The cursor moves to the **System Name** field.
3. Use **↓** to move the cursor to the **Time Sync Method** field.
4. If **TIMEP** is not already selected, use the Space bar to select **TIMEP**, then press **↓** once to display and move to the **TimeP Mode** field.
5. Do one of the following:
 - Use the Space bar to select the **DHCP** mode, then press **↓** to move the cursor to the **Poll Interval** field, and go to step 6.

Time Protocols

TimeP: Viewing, Selecting, and Configuring

```
Time Sync Method [None] : TIMEP
TimeP Mode [Disabled] : DHCP
Poll Interval (min) [720] : 720
Time Zone [0] : 0
Daylight Time Rule [None] : None
```

- Use the Space bar to select the **Manual** mode.
 - i. Press **→** to move the cursor to the **Server Address** field.
 - ii. Enter the IP address of the TimeP server you want the switch to use for time synchronization.
Note: This step replaces any previously configured TimeP server IP address.
 - iii. Press **→** to move the cursor to the **Poll Interval** field, then go to step 6.

```
Time Sync Method [None] : TIMEP
TimeP Mode [Disabled] : Manual      Server Address : 10.28.227.141
Poll Interval (min) [720] : 720
Time Zone [0] : 0
Daylight Time Rule [None] : None
```

6. In the **Poll Interval** field, enter the time in minutes that you want for a TimeP Poll Interval.

Press **[Enter]** to return to the Actions line, then **[S]** (for **Save**) to enter the new time protocol configuration in both the startup-config and running-config files.

CLI: Viewing and Configuring TimeP

CLI Commands Described in this Section

show timep	page 9-17
[no] timesync	page 9-18 ff., 9-20
ip timep	
dhcp	page 9-18
manual	page 9-19
server <ip-addr>	page 9-19
interval	page 9-20
no ip timep	page 9-21

This section describes how to use the CLI to view, enable, and configure TimeP parameters.

Viewing the Current TimeP Configuration

This command lists both the time synchronization method (TimeP, SNTP, or None) and the TimeP configuration, even if SNTP is not the selected time protocol.

Syntax: show timep

For example, if you configure the switch with TimeP as the time synchronization method, then enable TimeP in DHCP mode with the default poll interval, **show timep** lists the following:

```
ProCurve(config)# show timep
Timep Configuration
Time Sync Mode: Timep
TimeP Mode : DHCP      Poll Interval (min) : 720
```

Figure 9-10. Example of TimeP Configuration When TimeP Is the Selected Time Synchronization Method

If SNTP is the selected time synchronization method), **show timep** still lists the TimeP configuration even though it is not currently in use:

```
ProCurve(config)# show timep
Timep Configuration
Time Sync Mode: Sntp
TimeP Mode : DHCP      Poll Interval (min) : 720
```

Even though, in this example, SNTP is the current time synchronization method, the switch maintains the TimeP configuration.

Figure 9-11. Example of SNTP Configuration When SNTP Is Not the Selected Time Synchronization Method

Configuring (Enabling or Disabling) the TimeP Mode

Enabling the TimeP mode means to configure it for either broadcast or unicast mode. Remember that to run TimeP as the switch's time synchronization protocol, you must also select TimeP as the time synchronization method by using the CLI `timesync` command (or the Menu interface **Time Sync Method** parameter).

Syntax: `timesync timep`
Selects TimeP as the time protocol.

`ip timep < dhcp | manual >`
Enables the selected TimeP mode.

`no ip timep`
Disables the TimeP mode.

`no timesync`
Disables the time protocol.

Enabling TimeP in DHCP Mode. Because the switch provides a TimeP polling interval (default: 720 minutes), you need only these two commands for a minimal TimeP DHCP configuration:

Syntax: `timesync timep`
Selects TimeP as the time synchronization method.

`ip timep dhcp`
Configures DHCP as the TimeP mode.

For example, suppose:

- Time synchronization is configured for SNTP.
- You want to:
 1. View the current time synchronization.
 2. Select TimeP as the time synchronization mode.
 3. Enable TimeP for DHCP mode.
 4. View the TimeP configuration.

The commands and output would appear as follows:

```
ProCurve(config)# show timep 1 show timep displays the TimeP configuration and also shows
Timep Configuration that SNTP is the currently active time synchronization mode.
  Time Sync Mode: Sntp
  TimeP Mode : Disabled

ProCurve(config)# timesync timep 2

ProCurve(config)# ip timep dhcp 3

ProCurve(config)# show timep 4 show timep again displays the TimeP configuration and shows that TimeP is
Timep Configuration now the currently active time synchronization mode.
  Time Sync Mode: Timep
  TimeP Mode : DHCP      Poll Interval (min) : 720
```

Figure 9-12. Example of Enabling TimeP Operation in DHCP Mode

Enabling Timep in Manual Mode. Like DHCP mode, configuring TimeP for **Manual** mode enables TimeP. However, for manual operation, you must also specify the IP address of the TimeP server. (The switch allows only one TimeP server.) To enable the TimeP protocol:

Syntax: timesync timep
Selects Timep.

ip timep manual <ip-addr>
Activates TimeP in Manual mode with a specified TimeP server.

no ip timep
Disables TimeP.

Note

To change from one TimeP server to another, you must (1) use the **no ip timep** command to disable TimeP mode, and then reconfigure TimeP in Manual mode with the new server IP address.

For example, to select TimeP and configure it for manual operation using a TimeP server address of 10.28.227.141 and the default poll interval (720 minutes, assuming the TimeP poll interval is already set to the default):

```
ProCurve(config)# timesync timep  
Selects TimeP.
```

```
ProCurve(config)# ip timep manual 10.28.227.141  
Activates TimeP in Manual mode.
```

```
ProCurve(config)# timesync timep
ProCurve(config)# ip timep manual 10.28.227.141

ProCurve(config)# Show timep
Timep Configuration
Time Sync Mode: Timep
TimeP Mode : Manual           Server Address : 10.28.227.141
Poll Interval (min) : 720
```

Figure 9-13. Example of Configuring Timep for Manual Operation

Changing the TimeP Poll Interval. This command lets you specify how long the switch waits between time polling intervals. The default is 720 minutes and the range is 1 to 9999 minutes. (This parameter is separate from the poll interval parameter used for SNTP operation.)

Syntax: ip timep dhcp interval < 1 .. 9999 >
 ip timep manual interval < 1 .. 9999 >

For example, to change the poll interval to 60 minutes:

```
ProCurve(config)# ip timep interval 60
```

Disabling Time Synchronization Without Changing the TimeP Configuration. The recommended method for disabling time synchronization is to use the **timesync** command. This halts time synchronization without changing your TimeP configuration.

Syntax: no timesync

For example, suppose TimeP is running as the switch's time synchronization protocol, with **DHCP** as the TimeP mode, and the factory-default polling interval. You would halt time synchronization with this command:

```
ProCurve(config)# no timesync
```

If you then viewed the TimeP configuration, you would see the following:

```
ProCurve(config)# show timep
Timep Configuration
Time Sync Mode: Disabled
TimeP Mode : DHCP       Poll Interval (min) : 720
```

Figure 9-14. Example of TimeP with Time Synchronization Disabled

Disabling the TimeP Mode. Disabling the TimeP mode means to configure it as disabled. (Disabling TimeP prevents the switch from using it as the time synchronization protocol, even if it is the selected **Time Sync Method** option.)

Syntax: no ip timep

*Disables TimeP by changing the TimeP mode configuration to **Disabled**.*

For example, if the switch is running TimeP in DHCP mode, **no ip timep** changes the TimeP configuration as shown below, and disables time synchronization on the switch.

```
ProCurve(config)# no ip timep

ProCurve(config)# show timep
Timep Configuration
  Time Sync Mode: Timep
  TimeP Mode : Disabled
```

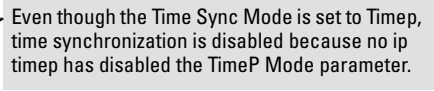

Even though the Time Sync Mode is set to Timep, time synchronization is disabled because no ip timep has disabled the TimeP Mode parameter.

Figure 9-15. Example of Disabling Time Synchronization by Disabling the TimeP Mode Parameter

SNTP Unicast Time Polling with Multiple SNTP Servers

When running SNTP unicast time polling as the time synchronization method, the switch requests a time update from the server you configured with either the Server Address parameter in the menu interface, or the primary server in a list of up to three SNTP servers configured using the CLI. If the switch does not receive a response from the primary server after three consecutive polling intervals, the switch tries the next server (if any) in the list. If the switch tries all servers in the list without success, it sends an error message to the Event Log and reschedules to try the address list again after the configured **Poll Interval** time has expired.

Address Prioritization

If you use the CLI to configure multiple SNTP servers, the switch prioritizes them according to the decimal values of their IP addresses. That is, the switch compares the decimal value of the octets in the addresses and orders them

accordingly, with the lowest decimal value assigned as the primary address, the second-lowest decimal value assigned as the next address, and the third-lowest decimal value as the last address. If the first octet is the same between two of the addresses, the second octet is compared, and so on. For example:

SNTP Server IP Address	Server Ranking According to Decimal Value of IP Address
10.28.227.141	Primary
10.28.227.153	Secondary
10.29.227.100	Tertiary

Adding and Deleting SNTP Server Addresses

Adding Addresses. As mentioned earlier, you can configure one SNTP server address using either the Menu interface or the CLI. To configure a second and third address, you must use the CLI. For example, suppose you have already configured the primary address in the above table (10.28.227.141). To configure the remaining two addresses, you would do the following:

```

ProCurve(config)# sntp server 10.29.227.100
ProCurve(config)# sntp server 10.28.227.153
ProCurve(config)# show sntp
SNTP Configuration
Time Sync Mode: Sntp
SNTP Mode : disabled
Poll Interval (sec) [720] : 720
IP Address      Protocol Version
-----
10.28.227.141  3
10.28.227.153  3
10.29.227.100  3
    
```

Prioritized list of SNTP Server IP Addresses

Figure 9-16. Example of SNTP Server Address Prioritization

Note

If there are already three SNTP server addresses configured on the switch, and you want to use the CLI to replace one of the existing addresses with a new one, you must delete the unwanted address before you configure the new one.

Deleting Addresses. To delete an address, you must use the CLI. If there are multiple addresses and you delete one of them, the switch re-orders the address priority. (See “Address Prioritization” on page 9-21.)

Syntax: no sntp server <ip-addr>

For example, to delete the primary address in the above example (and automatically convert the secondary address to primary):

```
ProCurve(config)# no sntp server 10.28.227.141
```

Menu Interface Operation with Multiple SNTP Server Addresses Configured

When you use the Menu interface to configure an SNTP server IP address, the new address writes over the current primary address, if one is configured. If there are multiple addresses configured, the switch re-orders the addresses according to the criteria described under “Address Prioritization” on page 9-21. For example, suppose the switch already has the following three SNTP server IP addresses configured.

- 10.28.227.141 (primary)
- 10.28.227.153 (secondary)
- 10.29.227.100 (tertiary)

If you use the Menu interface to add 10.28.227.160, the new prioritized list will be:

New Address List	Address Status
10.28.227.153	New Primary (The former primary, 10.28.227.141 was deleted when you used the menu to add 10.28.227.160.)
10.28.227.160	New Secondary
10.29.227.100	Same Tertiary (This address still has the highest decimal value.)

SNTP Messages in the Event Log

If an SNTP time change of more than three seconds occurs, the switch's event log records the change. SNTP time changes of less than three seconds do not appear in the Event Log.

Port Status and Basic Configuration

Contents

Overview	10-3
Viewing Port Status and Configuring Port Parameters	10-3
Menu: Viewing Port Status and Configuring Port Parameters	10-5
CLI: Viewing Port Status and Configuring Port Parameters	10-7
Using the CLI To View Port Status	10-7
Viewing Transceiver Status	10-9
Displaying Spanning Tree Configuration Details	10-11
Using the CLI To Configure Ports	10-11
Using the CLI To Configure a Broadcast Limit	10-12
Configuring HP Auto-MDIX	10-13
Manual Auto-MDIX Override	10-14
Web: Viewing Port Status and Configuring Port Parameters	10-16
Jumbo Packets	10-17
Terminology	10-17
Operating Rules	10-18
Configuring Jumbo Packet Operation	10-18
Overview	10-19
Viewing the Current Jumbo Configuration	10-19
Enabling or Disabling Jumbo Traffic on a VLAN	10-21
Operating Notes for Jumbo Traffic-Handling	10-22
Troubleshooting	10-24
QoS Pass-Through Mode	10-25
General Operation	10-25
Priority Mapping With and Without QoS Pass-Through Mode ..	10-26
How to enable/disable QoS Pass-Through Mode	10-26
Configuring Port-Based Priority for Incoming Packets	10-28
The Role of 802.1Q VLAN Tagging	10-28
Outbound Port Queues and Packet Priority Settings	10-29
Operating Rules for Port-Based Priority	10-30

Port Status and Basic Configuration

Contents

Configuring and Viewing Port-Based Priority	10-31
Messages Related to Prioritization	10-32
Troubleshooting Prioritization	10-32
Using Friendly (Optional) Port Names	10-33
Configuring and Operating Rules for Friendly Port Names	10-33
Configuring Friendly Port Names	10-34
Displaying Friendly Port Names with Other Port Data	10-35

Overview

This chapter describes how to view the current port configuration and how to configure ports to non-default settings, including

- Enable/Disable
- Mode (speed and duplex)
- Flow Control
- Broadcast Limit
- Auto-MDIX
- Jumbo Packets
- QoS Pass-Through Mode
- Configuring Port-Based Priority for Incoming Packets
- Using Friendly (Optional) Port Names

Viewing Port Status and Configuring Port Parameters

Port Status and Configuration Features

Feature	Default	Menu	CLI	Web
viewing port status	n/a	page 10-5	page 10-7	page 10-16
configuring ports	See Table 10-1 on pages 10-4 and 10-4.	page 10-6	page 10-11	page 10-16

Note On Connecting Transceivers to Fixed-Configuration Devices

If the switch either fails to show a link between an installed transceiver and another device, or demonstrates errors or other unexpected behavior on the link, check the port configuration on both devices for a speed and/or duplex (mode) mismatch. To check the mode setting for a port on the switch, use either the Port Status screen in the menu interface (page 10-5) or **show interfaces brief** in the CLI (page 10-7).

Port Status and Basic Configuration

Viewing Port Status and Configuring Port Parameters

Table 10-1. Status and Parameters for Each Port Type

Status or Parameter	Description
Enabled	<p>Yes (default): The port is ready for a network connection.</p> <p>No: The port will not operate, even if properly connected in a network. Use this setting, for example, if the port needs to be shut down for diagnostic purposes or while you are making topology changes.</p>
Status (read-only)	<p>Up: The port senses a linkbeat.</p> <p>Down: The port is not enabled, has no cables connected, or is experiencing a network error. For troubleshooting information, see the installation manual you received with the switch. See also chapter 11, "Troubleshooting" (in this manual).</p>
Mode	<p>10/100/1000Base-T:</p> <ul style="list-style-type: none">• Auto-10: Allows the port to negotiate between half-duplex (HDx) and full-duplex (FDx) while keeping speed at 10 Mbps. Also negotiates flow control (enabled or disabled). ProCurve recommends Auto-10 for links between 10/100 autosensing ports connected with Cat 3 cabling. (Cat 5 cabling is required for 100 Mbps links.)• 10HDx: 10 Mbps, Half-Duplex• 10FDx: 10 Mbps, Full-Duplex• Auto (default): Senses speed and negotiates with the port at the other end of the link for port operation (MDI-X or MDI). To see what the switch negotiates for the Auto setting, use the CLI show interfaces brief command or the "3. Port Status" option under "1. Status and Counters" in the menu interface.• Auto-100: Uses 100 Mbps and negotiates with the port at the other end of the link for other port operation features.• Auto-1000: Uses 1000 Mbps and negotiates with the port at the other end of the link for other port operation features.• 100Hdx: Uses 100 Mbps, half-duplex.• 100Fdx: Uses 100 Mbps, Full-Duplex <p>Port Mode Notes: Ensure that the device attached to the port is configured for the same setting that you select here. If using "Auto", the device to which the port connects must also be using "Auto" and operate in compliance with the IEEE 802.3ab "Auto Negotiation" standard for 1000Base-T networks.</p> <p>Gigabit fiber-optic ports (Gigabit-SX, Gigabit-LX, Gigabit-LH and Gigabit 100FX):</p> <ul style="list-style-type: none">• 1000FDx: 1000 Mbps (1 Gbps), Full Duplex only• Auto (default): The port operates at 1000FDx and auto-negotiates flow control with the device connected to the port.
Auto-MDIX	<p>The switch supports Auto-MDIX on 1 Gb T/TX (copper) ports. (Fiber ports do not use this feature.)</p> <ul style="list-style-type: none">• Automdix: Configures the port for automatic detection of the cable type (straight-through or crossover).• MDI: Configures the port for connecting to a PC or other MDI device with a crossover cable.• MDIX: Configures the port for connecting to a switch, hub, or other MDI-X device with a straight-through cable.

Status or Parameter	Description
Flow Control	<ul style="list-style-type: none">Disabled (default): The port does not generate flow control packets, and drops any flow control packets it receives.Enabled: The port uses 802.3x Link Layer Flow Control, generates flow control packets, and processes received flow control packets. <p>With the port mode set to Auto (the default) and Flow Control enabled, the switch negotiates Flow Control on the indicated port. If the port mode is not set to Auto, or if Flow Control is disabled on the port, then Flow Control is not used.</p>
Group (menu) or Trunk Group (CLI)	<p>Menu Interface: Specifies the static trunk group, if any, to which a port belongs.</p> <p>CLI: Appears in the show lacp command output to show the LACP trunk, if any, to which a port belongs.</p> <p>Note: An LACP trunk requires a full-duplex link. In most cases, ProCurve recommends that you leave the port Mode setting at Auto (the default). Refer to “Trunk Group Operation Using LACP” on page 11-17. For more on port trunking, see Chapter 11, “Port Trunking” .</p>
Type	<p>This parameter appears in the CLI show trunk listing and, for a port in a trunk group, specifies the type of trunk group. The default Type is passive LACP, which can be displayed by using the CLI show lacp command.</p> <p>For more on port trunking, see “Port Trunking” on page Chapter 11, “Port Trunking” .</p>
Broadcast Limit	<p>Specifies the percentage of the theoretical maximum network bandwidth that can be used for broadcast and multicast traffic. Any broadcast or multicast traffic exceeding that limit will be dropped. Zero (0) means the feature is disabled.</p> <p>The broadcast-limit command operates at the port context level to set the broadcast limit on a per-port basis.</p>

Menu: Viewing Port Status and Configuring Port Parameters

From the menu interface, you can configure and view all port parameter settings and view all port status indicators.

Using the Menu To View Port Status. The menu interface displays the status for ports and (if configured) a trunk group.

From the Main Menu, select:

Status and Counters. . .

Port Status

Port Status and Basic Configuration

Viewing Port Status and Configuring Port Parameters

In this example, ports A7 and A8 have previously been configured as a trunk group.

```
----- CONSOLE - MANAGER MODE -----
                          Status and Counters - Port Status
-----+-----+-----+-----+-----+-----+-----+-----+
Port      Type      Intrusion  Enabled  Status   Mode      Flow
-----+-----+-----+-----+-----+-----+-----+
A1        10/100TX  No        Yes      Up        10HDx     off
A2        10/100TX  No        Yes      Up        100FDx    off
A3        10/100TX  No        Yes      Up        100FDx    off
A4        10/100TX  No        Yes      Up        100FDx    off
A5        10/100TX  No        Yes      Up        100FDx    off
A6        10/100TX  No        Yes      Up        10HDx     off
A7-Trk2   10/100TX  No        Yes      Up        100FDx    off
A8-Trk2   10/100TX  No        Yes      Up        100FDx    off
A9        10/100TX  No        Yes      Down     10HDx     off
A10       10/100TX  No        Yes      Down     10HDx     off
A11       10/100TX  No        Yes      Up        10HDx     off
-----+-----+-----+-----+-----+-----+-----+
Actions->  Back      Intrusion log  Help
-----+-----+-----+-----+-----+-----+
Return to previous screen.
Use up/down arrow keys to scroll to other entries, left/right arrow keys to
change action selection, and <Enter> to execute action.
```

Figure 10-1. Example of the Port Status Screen

Using the Menu To Configure Ports.

Note

The menu interface uses the same screen for configuring both individual ports and port trunk groups. For information on port trunk groups, see Chapter 11, “Port Trunking”.

1. From the Main Menu, Select:
 2. Switch Configuration...
 2. Port/Trunk Settings

```
----- CONSOLE - MANAGER MODE -----
                          Switch Configuration - Port/Trunk Settings
-----+-----+-----+-----+-----+-----+-----+
Port      Type      Enabled   Mode     Flow Ctrl  Group   Type
-----+-----+-----+-----+-----+-----+-----+
A1        10/100TX  | Yes     Auto     Disable    |
A2        10/100TX  | Yes     Auto     Disable    |
A3        10/100TX  | Yes     Auto     Disable    |
A4        10/100TX  | Yes     Auto     Disable    |
A5        10/100TX  | Yes     Auto     Disable    |
A6        10/100TX  | Yes     Auto     Disable    |
A7        10/100TX  | Yes     Auto     Disable    Trk2  Trunk
A8        10/100TX  | Yes     Auto     Disable    Trk2  Trunk
-----+-----+-----+-----+-----+-----+-----+
Actions->  Cancel    Edit      Save      Help
-----+-----+-----+-----+-----+-----+
Cancel changes and return to previous screen.
Use arrow keys to change action selection and <Enter> to execute action.
```

Figure 10-2. Example of Port/Trunk Settings with a Trunk Group Configured

2. Press [E] (for **E**dit). The cursor moves to the **Enabled** field for the first port.
3. Refer to the online help provided with this screen for further information on configuration options for these features.
4. When you have finished making changes to the above parameters, press [Enter], then press [S] (for **S**ave).

CLI: Viewing Port Status and Configuring Port Parameters

Port Status and Configuration Commands

show interfaces brief	below
show interfaces config	page 10-8
show tech transceivers	page 10-9
interface	page 10-11
show spanning tree	page 10-10

From the CLI, you can configure and view all port parameter settings and view all port status indicators.

Using the CLI To View Port Status

Use the following commands to display port status and configuration:

- **show interfaces brief:** Lists the full status and configuration for all ports on the switch.
- **show interface config:** Lists a subset of the data shown by the **show interfaces** command (above); that is, only the enabled/disabled, mode, and flow control status for all ports on the switch.

Syntax: show interfaces [brief | config]

These two commands display the information listed in table 10-2, below.

Table 10-2. Comparing the "Show Interfaces" Command Options*

Feature	Show Interfaces Brief	Show Interfaces Config
Port Number and Type	Yes	Yes
Enabled Y/N	Yes	Yes
Flow Control	Yes	Yes
Status Up/Down	Yes	No
Mode (Operating)	Yes	No

Port Status and Basic Configuration
Viewing Port Status and Configuring Port Parameters

Feature	Show Interfaces Brief	Show Interfaces Config
Intrusion Alert	Yes	No
Mode (Configured)	No	Yes
MDIX Mode	Operating	Configured

* There is also the **show interfaces [< port-number>]** option, which displays port statistics. Refer to “Viewing Port and Trunk Group Statistics and Flow Control Status” on page B-10.

The figures 10-3 through 10-6 list examples of the output of the above two commands for the same port configuration on two different switches.

```
ProCurve> show interfaces brief
Status and Counters - Port Status
Current Operating Mode
Port      Type      | Intrusion Alert  Enabled Status Mode      Flow Ctrl
-----
A1        10/100TX | No               Yes   Up   10HDx  off
A2        10/100TX | No               Yes   Up   100FDx off
A3        10/100TX | No               Yes   Up   100FDx off
A4        10/100TX | No               Yes   Up   100FDx off
A5        10/100TX | No               Yes   Up   100FDx off
A6        10/100TX | No               Yes   Up   100FDx off
A7-Trk2  10/100TX | No               Yes   Up   100FDx off
A8-Trk2  10/100TX | No               Yes   Up   100FDx off
.         .         | .               .     .     .     .
.         .         | .               .     .     .     .
.         .         | .               .     .     .     .
A17       10/100TX | No               Yes   Down 10HDx  off
-- MORE --, next page: Space, next line: Enter, quit: Control-C
```

Figure 10-3. Example Show Interface Command Listing

```
ProCurve> show interface config
Port Settings
Current Configured Mode
Port      Type      | Enabled Mode      Flow Ctrl
-----
A1        10/100TX | Yes   Auto   Disable
A2        10/100TX | Yes   Auto   Disable
A3        10/100TX | Yes   Auto   Disable
A4        10/100TX | Yes   Auto   Disable
A5        10/100TX | Yes   Auto   Disable
A6        10/100TX | Yes   Auto   Disable
A7-Trk2  10/100TX | Yes   Auto   Disable
A8-Trk2  10/100TX | Yes   Auto   Disable
.         .         | .     .     .
.         .         | .     .     .
.         .         | .     .     .
A18       10/100TX | Yes   Auto   Disable
-- MORE --, next page: Space, next line: Enter, quit: Control-C
```

Figure 10-4. Example Show Interface Config Command Listing

```
ProCurve# show interface brief
```

Status and Counters - Port Status

Port	Type	Intrusion Alert	Enabled	Status	Current Operating Mode		Flow Ctrl	Bcast Limit
					Mode	MDI Mode		
1	100/1000T	No	Yes	Down	1000FDx	MDIX	off	0
2	100/1000T	No	Yes	Down	1000FDx	MDIX	off	0
3	100/1000T	No	Yes	Down	1000FDx	MDI	off	0
4	100/1000T	No	Yes	Down	1000FDx	MDI	off	0
5	100/1000T	No	Yes	Down	1000FDx	MDIX	off	0
6	100/1000T	No	Yes	Down	1000FDx	MDI	off	0
7	100/1000T	No	Yes	Down	1000FDx	MDI	off	0
8	100/1000T	No	Yes	Down	1000FDx	MDIX	off	0
9	100/1000T	No	Yes	Down	1000FDx	MDIX	off	0
10	100/1000T	No	Yes	Down	1000FDx	MDIX	off	0

Figure 10-5. Example Show Interface Brief Command Listing

```
ProCurve# show interface config
```

Port Settings

Port	Type	Current Configured Mode			
		Enabled	Mode	Flow Ctrl	MDI
1	100/1000T	Yes	Auto	Disable	Auto
2	100/1000T	Yes	Auto	Disable	Auto
3	100/1000T	Yes	Auto	Disable	Auto
4	100/1000T	Yes	Auto	Disable	Auto
5	100/1000T	Yes	Auto	Disable	Auto
6	100/1000T	Yes	Auto	Disable	Auto
7	100/1000T	Yes	Auto	Disable	Auto
8	100/1000T	Yes	Auto	Disable	Auto
9	100/1000T	Yes	Auto	Disable	Auto
10	100/1000T	Yes	Auto	Disable	Auto

Figure 10-6. Example Show Interface Config Command Listing

Viewing Transceiver Status

The **show tech transceivers** command allows you to:

- Remotely identify transceiver type and revision number without having to physically remove an installed transceiver from its slot.
- Display real-time status information about all installed transceivers, including non-operational transceivers.

Figure 10-7 shows sample output from the **show tech transceivers** command.

```
ProCurve# show tech transceivers

Transceiver Technical Information:
Port # | Type      | Prod # | Serial #      | Part #
-----+-----+-----+-----+-----
21     | 1000SX   | J4858B | CN605MP23K   |
22     | 1000LX   | J4859C | H117E7X      | 2157-2345
23     | ??       | ??     | non operational |

The following transceivers may not function correctly:
Port #      Message
-----+-----
Port 23     Self test failure.
```

Figure 10-7. Example of Show Tech Transceivers Command

Operating Notes:

- The following information is displayed for each installed transceiver:
 - Port number on which transceiver is installed.
 - Type of transceiver.
 - Product number—Includes revision letter, such as A, B, or C. If no revision letter follows a product number, this means that no revision is available for the transceiver.
 - Part number—Allows you to determine the manufacturer for a specified transceiver and revision number.
- For a non-ProCurve installed transceiver (see line 23 Figure 10-7), no transceiver type, product number, or part information is displayed. In the Serial Number field, **non-operational** is displayed instead of a serial number.
- The following error messages may be displayed for a non-operational transceiver:
 - Unsupported Transceiver. (SelfTest Err#060)
Check: www.hp.com/rnd/device_help/2_inform for more info.
 - This switch only supports revision B and above transceivers. Check: www.hp.com/rnd/device_help/2_inform for more info.
 - Self test failure.
 - Transceiver type not supported in this port.

- Transceiver type not supported in this software version.
- Not a ProCurve Transceiver. Please go to: www.hp.com/rnd/device_help/2_inform for more info.

Displaying Spanning Tree Configuration Details

To view detailed statistics on spanning tree operation for different ports, use the **show spanning-tree** command.

Syntax: show spanning-tree <port-list> detail

Lists 802.1D and 802.1w port operating statistics for all ports, or those specified.

You can also use this command to view spanning tree parameters on a static trunk (see page 11-8). For information on how to configure spanning tree, see the chapter on “Spanning-Tree Operation” in the *Advanced Traffic Management Guide*.

Using the CLI To Configure Ports

You can configure one or more of the following port parameters. For details on each option, see Table 10-1 on page 10-4.

Syntax: [no] interface <[ethernet] port-list>
disable | enable
speed-duplex
 <10-half | 100-half | 10-full | 100-full | 1000-full | auto |
 auto-10 | auto-100 | auto-1000 >
flow-control

Note that in the above syntax you can substitute an “**int**” for “**interface**” and an “**e**” for “**ethernet**”; that is **int e <port-list>**.

For example, to configure ports C1 through C3 and port C6 for 100 Mbps full-duplex, you would enter these commands:

```
ProCurve(config)# int e c1-c3,c6 speed-duplex 100-full
```

Similarly, to configure a single port with the settings in the above command, you could either enter the same command with only the one port identified, or go to the *context level* for that port and then enter the command. For example, to enter the context level for port C6 and then configure that port for 100FDx:

Port Status and Basic Configuration

Viewing Port Status and Configuring Port Parameters

```
ProCurve(config)# int e c6
ProCurve(eth-C6)# speed-duplex 100-full
```

If port C8 was disabled, and you wanted to enable it and configure it for 100FDx with flow-control active, you could do so with either of the following command sets.

- These commands enable and configure port C8 from the config level:

```
ProCurve(config)# int e c8 enable
ProCurve(config)# int e c8 speed-duplex 100-full
ProCurve(config)# int e c8 flow-control
```

- These commands select the context level for port C8 and then apply all of the configuration commands to port C8:

```
ProCurve(config)# int e c8
ProCurve(eth-C8)# enable
ProCurve(eth-C8)# speed-duplex 100-full
ProCurve(eth-C8)# flow-control
```

Using the CLI To Configure a Broadcast Limit

The switches covered in this guide use per-port broadcast-limit settings. This command operates at the port context level to configure an individual instance of the broadcast limit for the ports included in a given context. The switch implements the new broadcast limit immediately in the running-config file. (Rebooting is not necessary.) Use **write-memory** to save the configuration to the startup-config file.

Syntax: interface < port-list > broadcast-limit < 0 - 99 >

Configures the theoretical maximum bandwidth percentage that can be used on the specified switch port(s) for broadcasts and multicasts. The switch drops any broadcast or multicast traffic exceeding that limit. Zero (0) disables the feature on the specified port(s).

For example, to configure a broadcast limit of 45% on ports 1 - 10 in a switch covered in this guide:

Configures a broadcast limit of 45% on ports 5 - 7 in the running configuration.	ProCurve(config)# int 2-3 broadcast-limit 90 ProCurve(config)# show running
Displays the broadcast-limit in the running-config file.	Running configuration: ; J9022A Configuration Editor; Created on release #N.10.XX
	hostname "ProCurve Switch" interface 1 no lACP exit interface 2 broadcast-limit 90 no lACP exit interface 3 broadcast-limit 90 no lACP

Figure 10-8. Configuring and Displaying a Per-Port Broadcast Limit on Switch 2810

Configuring HP Auto-MDIX

Copper ports on the switch can automatically detect the type of cable configuration (MDI or MDI-X) on a connected device and adjust to operate appropriately.

This means you can use a “straight-through” twisted-pair cable or a “cross-over” twisted-pair cable for any of the connections—the port makes the necessary adjustments to accommodate either one for correct operation. The 10/100/1000-T port supports the IEEE 802.3ab standard, which includes the “Auto MDI/MDI-X” feature.

Using the 10/100/100-T port:

- If you connect a copper port using a straight-through cable to a port on another switch or hub that uses MDI-X ports, the switch port automatically operates as an MDI port.
- If you connect a copper port using a straight-through cable to a port on an end node, such as a server or PC, that uses MDI ports, the switch port automatically operates as an MDI-X port.

HP Auto-MDIX was developed for auto-negotiating devices, and was shared with the IEEE for the development of the IEEE 802.3ab standard. HP Auto-MDIX and the IEEE 802.3ab Auto MDI/MID-X feature are completely compatible. Additionally, HP Auto-MDIX supports operation in forced speed and duplex modes.

If you want more information on this subject please refer to the *IEEE 802.3ab Standard Reference*.

For more information on MDI-X, refer to the appendix titled “Switch Ports and Network Cables” in the *Installation and Getting Started Guide* for your switch.

Manual Auto-MDIX Override

If you require control over the MDI/MDI-X feature you can set the switch to either of two non-default modes:

- Manual MDI
- Manual MDI-X

Table 10-1 shows the cabling requirements for the MDI/MDI-X settings.

Table 10-1. Cable Types for Auto and Manual MDI/MDI-X Settings

Setting	MDI/MDI-X Device Type	
	PC or Other MDI Device Type	Switch, Hub, or Other MDI-X Device
Manual MDI	Crossover Cable	Straight-Through Cable
Manual MDI-X	Straight-Through Cable	Crossover Cable
Auto-MDI-X (The Default)	Either Crossover or Straight-Through Cable	

The Auto-MDIX features apply only to copper port switches using twisted-pair copper Ethernet cables.

Syntax: interface < port-list > mdix-mode < automdix | mdi | mdix >

automdix is the automatic, default setting. This configures the port for automatic detection of the cable (either straight-through or crossover).

mdi is the manual mode setting that configures the port for connecting to either a PC or other MDI device with a crossover cable, or to a switch, hub, or other MDI-X device with a straight-through cable.

mdix is the manual mode setting that configures the port for connecting to either a switch, hub, or other MDI-X device with a crossover cable, or to a PC or other MDI device with a straight-through cable.

Syntax: show interfaces config

Lists the current per-port Auto/MDI/MDI-X configuration.

Syntax: show interfaces brief

*Where a port is linked to another device, this command lists the MDI mode the port is currently using. In the case of ports configured for **Auto (auto-mdix)**, the MDI mode appears as either **MDI** or **MDIX**, depending upon which option the port has negotiated with the device on the other end of the link. In the case of ports configured for **MDI** or **MDIX**, the mode listed in this display matches the configured setting. If the link to another device was up, but has gone down, this command shows the last operating MDI mode the port was using. If a port on a given switch has not detected a link to another device since the last reboot, this command lists the MDI mode to which the port is currently configured.*

For example, **show interfaces config** displays the following data when port 1 is configured for **auto-mdix**, port 2 is configured for **mdi**, and port 3 is configured for **mdix**.

```
ProCurve(config)# show interfaces config
```

Port Settings						Per-Port MDI Configuration
Port	Type	Enabled	Mode	Flow Ctrl	MDI	
1	10/100TX	Yes	Auto	Disable	Auto	
2	10/100TX	Yes	Auto	Disable	MDI	
3	10/100TX	Yes	Auto	Disable	MDIX	
4	10/100TX	Yes	Auto	Disable	Auto	
5	10/100TX	Yes	Auto	Disable	Auto	
:	:	:	:	:	:	
:	:	:	:	:	:	

Figure 10-9. Example of Displaying the Current MDI Configuration

```
ProCurve(config)# show interfaces brief
```

Status and Counters - Port Status								Per-Port MDI Operating Mode
Port	Type	Intrusion Alert	Enabled	Status	Mode	MDI Mode	Flow Ctrl	
1	10/100TX	No	Yes	Up	100FDx	MDIX	off	
2	10/100TX	No	Yes	Up	100FDx	MDI	off	
3	10/100TX	No	Yes	Up	100FDx	MDIX	off	
4	10/100TX	No	Yes	Down	10FDx	Auto	off	
5	10/100TX	No	Yes	Down	10FDx	Auto	off	
:	:	:	:	:	:	:	:	
:	:	:	:	:	:	:	:	

Figure 10-10. Example of Displaying the Current MDI Operating Mode

Note

Port Response to Switch Software Updates

- Switch software updated from xx.xx.xx or earlier
 1. Copper ports in auto-negotiation still default to **auto-mdix** mode.
 2. Copper ports in forced speed/duplex default to **mdix** mode.

The default is **auto-mdix**. If the switch is reset to the factory defaults, these ports are configured as **auto-mdix**. Use the following CLI command to change the setting for individual ports:

```
interface < port-list > mdix-mode < automdix | mdi | mdix >
```

Web: Viewing Port Status and Configuring Port Parameters

In the web browser interface:

1. Click on the **Configuration** tab.
2. Click on **Port Configuration**.
3. Select the ports you want to modify and click on **Modify Selected Ports**.
4. After you make the desired changes, click on **Apply Settings**.

Note that the web browser interface displays an existing port trunk group. However, to configure a port trunk group, you must use the CLI or the menu interface. For more on this topic, see Chapter 11, “Port Trunking”.

Jumbo Packets

Feature	Default	Menu	CLI	Web
display VLAN jumbo status	n/a	—	10-19	—
configure jumbo VLANs	Disabled	—	10-21	—

The *Maximum Transmission Unit* (MTU) is the maximum size IP packet the switch can receive for Layer 2 packets inbound on a port. The switch drops any inbound packets larger than the MTU allowed on the port. On ports operating at 10 Mbps or 100 Mbps, the MTU is fixed at 1522 bytes. However, ports operating at 1 Gbps or 10 Gbps speeds accept forward packets of up to 9220 bytes (including four bytes for a VLAN tag) when configured for jumbo traffic. In switches covered in this guide, you can enable inbound jumbo packets on a per-VLAN basis. That is, on a VLAN configured for jumbo traffic, all ports belonging to that VLAN and *operating* at 1 Gbps or 10 Gbps allow inbound jumbo packets of up to 9220 bytes. (Regardless of the mode configured on a given jumbo-enabled port, if the port is operating at only 10 Mbps or 100 Mbps, only packets that do not exceed 1522 bytes are allowed inbound on that port.)

Terminology

Jumbo Packet: An IP packet exceeding 1522 bytes in size. The maximum Jumbo packet size is 9220 bytes. (This size includes 4 bytes for the VLAN tag.)

Jumbo VLAN: A VLAN configured to allow inbound jumbo traffic. All ports belonging to a jumbo and operating at 1 Gbps or higher can receive jumbo packets from external devices.

MTU (*Maximum Transmission Unit*): This is the maximum-size IP packet the switch can receive for Layer 2 packets inbound on a port. The switch allows jumbo packets of up to 9220 bytes.

Standard MTU: An IP packet of 1522 bytes in size. (This size includes 4 bytes for the VLAN tag.)

Operating Rules

- **Required Port Speed:** The switches allow inbound and outbound jumbo packets on ports operating at speeds of 1 gigabit or higher. At lower port speeds, only standard (1522-byte or smaller) packets are allowed, regardless of the jumbo configuration.
- **Flow Control:** Disable flow control (the default setting) on any ports or trunks through which you want to transmit or receive jumbo packets. Leaving flow control enabled on a port can cause a high rate of jumbo drops to occur on the port.
- **GVRP Operation:** A VLAN enabled for jumbo traffic cannot be used to create a dynamic VLAN. A port belonging to a statically configured, jumbo-enabled VLAN cannot join a dynamic VLAN.
- **Port Adds and Moves:** If you add a port to a VLAN that is already configured for jumbo traffic, the switch enables that port to receive jumbo traffic. If you remove a port from a jumbo-enabled VLAN, the switch disables jumbo traffic capability on the port only if the port is not currently a member of another jumbo-enabled VLAN. This same operation applies to port trunks.
- **Jumbo Traffic Sources:** A port belonging to a jumbo-enabled VLAN can receive inbound jumbo packets through any VLAN to which it belongs, including non-jumbo VLANs. For example, if VLAN 10 (without jumbos enabled) and VLAN 20 (with jumbos enabled) are both configured on a switch, and port 1 belongs to both VLANs, then port 1 can receive jumbo traffic from devices on either VLAN. For a method to allow only some ports in a VLAN to receive jumbo traffic, refer to “Operating Notes for Jumbo Traffic-Handling” on page 10-22.

Configuring Jumbo Packet Operation

Command	Page
show vlans	10-20
show vlans ports < port-list >	10-20
show vlans < vid >	10-21
jumbo	10-21

Overview

1. Determine the VLAN membership of the ports or trunks through which you want the switch to accept inbound jumbo traffic. For operation with GVRP enabled, refer to the GVRP topic under “Operating Rules”, above.
2. Ensure that the ports through which you want the switch to receive jumbo packets are operating at least at gigabit speed. (Check the **Mode** field in the output for the **show interfaces brief <port-list>** command.)
3. Use the **jumbo** command to enable jumbo packets on one or more VLANs statically configured in the switch. (All ports belonging to a jumbo-enabled VLAN can receive jumbo packets.)
4. Execute **write memory** to save your configuration changes to the startup-config file.

Viewing the Current Jumbo Configuration

Syntax: show vlans

*Lists the static VLANs configured on the switch and includes a **Jumbo** column to indicate which VLANs are configured to support inbound jumbo traffic. All ports belonging to a jumbo-enabled VLAN can receive jumbo traffic. (For more information refer to “Operating Notes for Jumbo Traffic-Handling” on page 10-22.) See figure 10-11, below.*

```
ProCurve(config)# show vlans
```

Status and Counters - VLAN Information

Maximum VLANs to support : 8
Primary VLAN : DEFAULT_VLAN
Management VLAN :

802.1Q VLAN ID	Name	Status	Voice	Jumbo
1	DEFAULT_VLAN		No	Yes
5	VLAN5		No	No
22	VLAN22		No	No

Indicates which static VLANs are configured to enable jumbo packets.

Figure 10-11. Example Listing of Static VLANs To Show Jumbo Status Per VLAN

Syntax: show vlans ports < port-list >

*Lists the static VLANs to which the specified port(s) belong, including the **Jumbo** column to indicate which VLANs are configured to support jumbo traffic. Entering only one port in < port-list > results in a list of all VLANs to which that port belongs. Entering multiple ports in < port-list > results in a superset list that includes the VLAN memberships of all ports in the list, even though the individual ports in the list may belong to different subsets of the complete VLAN listing. For example, if port 1 belongs to VLAN 1, port 2 belongs to VLAN 10, and port 3 belongs to VLAN 15, then executing this command with a < port-list > of **1-3** results in a listing of all three VLANs, even though none of the ports belong to all three VLANs. (Refer to figure 10-12.)*

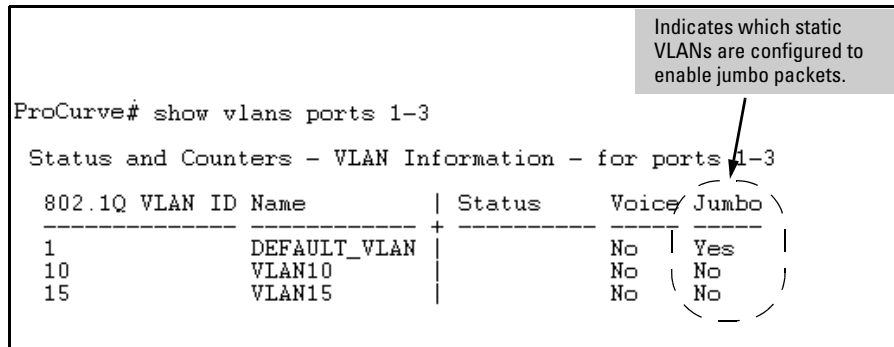

Figure 10-12. Example of Listing the VLAN Memberships for a Range of Ports

Syntax: show vlans < vid >

This command shows port membership and jumbo configuration for the specified < vid >.

```

ProCurve(config)# show vlan 100
Status and Counters - VLAN Information - Ports - VLAN 100
802.1Q VLAN ID : 100
Name : VLAN100
Status :
Voice : No
Jumbo : No

```

Port	Information Mode	Unknown VLAN	Status
1	Tagged	Learn	Up
2	Tagged	Learn	Up
3	Tagged	Learn	Up
4	Tagged	Learn	Down
5	Tagged	Learn	Up

Lists the ports belonging to VLAN 100 and whether the VLAN is enabled for jumbo packet traffic.

Figure 10-13. Example of Listing the Port Membership and Jumbo Status for a VLAN

Enabling or Disabling Jumbo Traffic on a VLAN

Syntax: `vlan < vid > jumbo`
`[no] vlan < vid > jumbo`

*Configures the specified VLAN to allow jumbo packets on all ports on the switch that belong to that VLAN. If the VLAN is not already configured on the switch, **vlan < vid > jumbo** also creates the VLAN. Note that a port belonging to one jumbo VLAN can receive jumbo packets through any other VLAN statically configured on the switch, regardless of whether the other VLAN is enabled for jumbo packets. The **[no]** form of the command disables inbound jumbo traffic on all ports in the specified VLAN that do not also belong to another VLAN that is enabled for jumbo traffic. In a VLAN context, the command forms are **jumbo** and **no jumbo**. (Default: Jumbos disabled on the specified VLAN.)*

Operating Notes for Jumbo Traffic-Handling

- ProCurve does not recommend configuring a voice VLAN to accept jumbo packets. Voice VLAN packets are typically small, and allowing a voice VLAN to accept jumbo packet traffic can degrade the voice transmission performance.
- You can configure the default, primary, and/or (if configured) the management VLAN to accept jumbo packets on all ports belonging to the VLAN.
- When the switch applies the default MTU (1522-bytes) to a VLAN, all ports in the VLAN can receive incoming packets of up to 1522 bytes in length. When the switch applies the jumbo MTU (9220 bytes) to a VLAN, all ports in that VLAN can receive incoming packets of up to 9220 bytes in length. A port receiving packets exceeding the applicable MTU drops such packets, causing the switch to generate an Event Log message and increment the “Giant Rx” counter (displayed by **show interfaces < port-list >**).
- The switch does not allow flow control and jumbo packet capability to co-exist on a port. Attempting to configure both on the same port generates an error message in the CLI and sends a similar message to the Event Log.
- The default MTU is 1522 bytes (including 4 bytes for the VLAN tag). The jumbo MTU is 9220 bytes (including 4 bytes for the VLAN tag).
- When a port is not a member of any jumbo-enabled VLAN, it drops all jumbo traffic. If the port is receiving “excessive” inbound jumbo traffic, the port generates an Event Log message to notify you of this condition. This same condition generates a Fault-Finder message in the Alert log of the switch’s web browser interface, and also increments the switch’s “Giant Rx” counter.
- If you do not want all ports in a given VLAN to accept jumbo packets, you can consider creating one or more jumbo VLANs with a membership comprised of only the ports you want to receive jumbo traffic. Because a port belonging to one jumbo-enabled VLAN can receive jumbo packets through any VLAN to which it belongs, this method enables you to include both jumbo-enabled and non-jumbo ports within the same VLAN. For example, suppose you wanted to allow inbound jumbo packets only on ports 6, 7, 12, and 13. However, these ports are spread across VLAN 100 and VLAN 200, and also share these VLANs with other ports you want

excluded from jumbo traffic. A solution is to create a third VLAN with the sole purpose of enabling jumbo traffic on the desired ports, while leaving the other ports on the switch disabled for jumbo traffic. That is:

	VLAN 100	VLAN 200	VLAN 300
Ports	6-10	11-15	6, 7, 12, and 13
Jumbo-Enabled?	No	No	Yes

If there are security concerns with grouping the ports as shown for VLAN 300, you can either use source-port filtering to block unwanted traffic paths or create separate jumbo VLANs, one for ports 6 and 7, and another for ports 12 and 13.

- Outbound Jumbo Traffic.** Any port operating at 1 Gbps or higher can transmit outbound jumbo packets through any VLAN, regardless of the jumbo configuration. The VLAN is not required to be jumbo-enabled, and the port is not required to belong to any other, jumbo-enabled VLANs. This can occur in situations where a non-jumbo VLAN includes some ports that do not belong to another, jumbo-enabled VLAN and some ports that do belong to another, jumbo-enabled VLAN. In this case, ports capable of receiving jumbo packets can forward them to the ports in the VLAN that do not have jumbo capability.

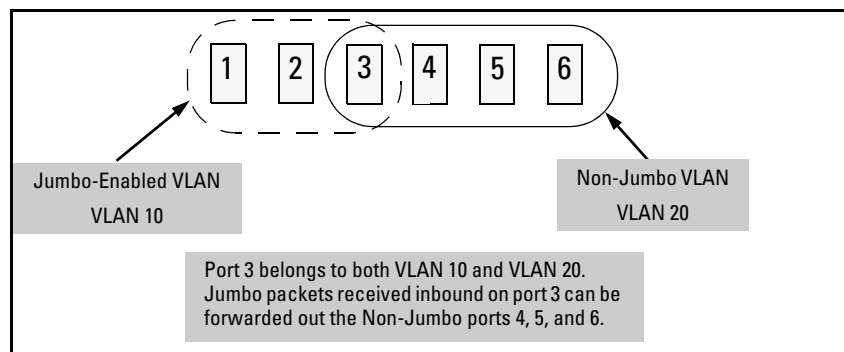

Figure 10-14. Forwarding Jumbo Packets Through Non-Jumbo Ports

Jumbo packets can also be forwarded out non-jumbo ports when the jumbo packets received inbound on a jumbo-enabled VLAN are routed to another, non-jumbo VLAN for outbound transmission on ports that have no memberships in other, jumbo-capable VLANs. Where either of the above scenarios is a possibility, the downstream device must be configured to accept the jumbo traffic. Otherwise, this traffic will be dropped by the downstream device.

Troubleshooting

A VLAN is configured to allow jumbo packets, but one or more ports drops all inbound jumbo packets. The port may not be operating at 1 gigabit or higher. Regardless of a port's configuration, if it is actually operating at a speed lower than 1 gigabit, it drops inbound jumbo packets. For example, if a port is configured for **Auto** mode (**speed-duplex auto**), but has negotiated a 100 Mbps speed with the device at the other end of the link, then the port cannot receive inbound jumbo packets. To determine the actual operating speed of one or more ports, view the **Mode** field in the output for the following command:

```
show interfaces brief <port-list >
```

A non-jumbo port is generating “Excessive undersize/giant packets” messages in the Event Log. The switch can transmit outbound jumbo traffic on any port, regardless of whether the port belongs to a jumbo VLAN. In this case, another port in the same VLAN on the switch may be jumbo-enabled through membership in a different, jumbo-enabled VLAN, and may be forwarding jumbo packets received on the jumbo VLAN to non-jumbo ports. Refer to “Outbound Jumbo Traffic” on page 10-23.

QoS Pass-Through Mode

QoS Pass-Through mode is designed to enhance the performance of line-rate traffic transfers through the switches covered in this guide. This feature should only be used in environments where Quality of Service (QoS) is not of major importance, but where lossless data transfers are key. This command disables any discrimination of QoS queues for traffic, consolidating packet buffer memory to provide line-rate flows with no loss of data.

General Operation

The port buffering design for the switch has been optimized for gigabit-to-gigabit traffic flows. For this reason, some flows from Gigabit-to-100Base or even 100Base-to-10Base may not perform as well as would be expected. The QoS Pass-Through mode enhancement can provide a significant performance improvement for high-bandwidth traffic flows through the switch, particularly when running traffic flows from 1000Base to either 100Base or 10Base connections.

QoS Pass-Through mode is enabled by default. If it has been disabled, you can re-enable it via the “config” context of the CLI by entering the CLI command **qos-passthrough-mode**, followed by **write memory** and rebooting the switch.

QoS Pass-Through mode, when enabled, results in the following general changes to switch operation:

- Alters the switch's default outbound priority queue scheme from four queues (low, normal, medium, and high), to two queues (normal & high).
- Optimizes outbound port buffers for a two-queue scheme.
- All packets received with an 802.1p priority tag of 0 to 5 (low, normal, or medium priorities), or tagged by the switch's QoS feature, will be serviced by the (now larger) "normal" priority queue.
- All packets received with an 802.1p priority tag of 6 or 7 (high priority), or tagged by the switch's QoS feature, will be serviced by the "high" priority queue.
- High priority packets sourced by the switch itself, such as Spanning Tree packets, will be serviced in the "high" priority queue.

- Any 802.1p tagging on a received packet, or any tag added to a received frame by the switch via its QoS configuration, will be preserved as it is transmitted from the switch.

Note

As stated earlier, use of this QoS-Passthrough-Mode feature generally assumes that QoS tagged packets are not being sent through the switch. The receipt of priority 6 or 7 packets may in fact suffer packet drops depending on the traffic load of non-priority 6 or 7 packets.

Priority Mapping With and Without QoS Pass-Through Mode

The switch supports 802.1p VLAN tagging, which is used in conjunction with the outbound port priority queues to prioritize outbound traffic.

An 802.1Q VLAN tagged packet carries an 802.1p priority setting (0-7). If the switch receives a tagged packet, it is placed into the appropriate queue based on the frame's 802.1p priority setting. The mapping with/without QoS Pass-Through Mode is as follows:

802.1p Priority Setting	Prioritization Queue Placement	
	Default QoS Setting	QoS Passthrough Mode
1	1 (low)	2 (normal)
2	1 (low)	2 (normal)
0 or Unspecified	2 (normal)	2 (normal)
3	2 (normal)	2 (normal)
4	3 (medium)	2 (normal)
5	3 (medium)	2 (normal)
6	4 (high)	4 (high)
7	4 (high)	4 (high)

How to enable/disable QoS Pass-Through Mode

QoS Pass-Through Mode is enabled by default.

Syntax: [no] qos-passthrough-mode
write memory
reload

*The above command sequence enables QoS pass-through mode. The **no** form of the command sequence disables QoS pass-through mode. (Default: Enabled)*

For example:

```
ProCurveconfig)# qos-passthrough-mode  
Command will take effect after saving configuration and  
reboot  
ProCurveconfig)# write memory  
ProCurve(config)# reload
```

This command can be enabled and disabled only from the switch's CLI. QoS passthrough mode cannot be enabled or disabled through either the switch's menu or web browser interfaces.

Once enabled, this feature adds **qos-passthrough-mode** to the switch's startup-config file. For example, in an otherwise default configuration, executing **show config** lists the startup-config file (with QoS pass-through mode enabled) as follows:

```
ProCurve Switch 2810-48G# show config  
  
; J9022A Configuration Editor; Created on release #N.10.XX  
  
hostname "ProCurve Switch"  
cdp run  
qos-passthrough-mode  
snmp-server community "public" Unrestricted
```

← Indicates QoS Pass-Through mode enabled.

Figure 10-15. Example of the Startup-Config File Listing with QoS Pass-Through Mode Enabled

Configuring Port-Based Priority for Incoming Packets

Feature	Default	Menu	CLI	Web
Assigning a priority level to traffic on the basis of incoming port	Disabled	n/a	page 10-31	n/a

When network congestion occurs, it is important to move traffic on the basis of relative importance. However, without prioritization:

- Traffic from less important sources can consume bandwidth and slow down or halt delivery of more important traffic.
- Most traffic from all ports is forwarded as normal priority, and competes for bandwidth with all other normal-priority traffic, regardless of its relative importance.

Traffic received in tagged VLAN packets carries a specific 802.1p priority level (0 - 7) that the switch recognizes and uses to assign packet priority at the outbound port. With the default port-based priority, the switch handles traffic received in untagged packets as “Normal” (priority level = 0).

You can assign a priority level to:

- Inbound, untagged VLAN packets
- Inbound, tagged VLAN packets having a priority level of 0 (zero)

(The switch does not alter the existing priority level of inbound, tagged VLAN packets carrying a priority level of 1-7.)

Thus, for example, high-priority tagged VLAN traffic received on a port retains its priority in the switch. However, you have the option of configuring the port to assign a priority level to untagged traffic and 0-priority tagged traffic the port receives.

The Role of 802.1Q VLAN Tagging

An 802.1Q-tagged VLAN packet carries the packet’s VLAN assignment and the 802.1p priority setting (0 - 7). (By contrast, an untagged packet does not have a tag and does not carry a priority setting.) Generally, the switch preserves and uses a packet’s priority setting to determine which outbound queue the packet belongs in on the outbound port. If the outbound port is a tagged member of the VLAN, the packet carries its priority setting to the next, downstream device. If the outbound port is not configured as a tagged member of the VLAN, then the tag is stripped from the packet, which then exits from the switch without a priority setting.

Outbound Port Queues and Packet Priority Settings

Ports on the ProCurve switches have the following outbound port queue structure:

Switch Model	Outbound Port Queues
Switch 6108	4
Series 5300xl Switch	4
Series 4100gl Switch	3
Series 3400cl Switch	
Series 2600, 2600-PWR Switch	4
Series 2800 Switch	4
Switch 2810	4
Series 2500 Switch	2
Switches 1600M/2400M/2424M/4000M/8000M	2

As shown below, these port queues map to the eight priority settings specified in the 802.1p standard.

Table 10-3. Mapping Priority Settings to Device Queues

802.1p Priority Settings Used In Tagged VLAN Packets	Switches with 3 Outbound Port Queues	Queue Assignment in Downstream Devices With:		
		4 Queues	8 Queues	2 Queues
1 (low)	Low	Low	↓ Low ↓ High	Low
2 (low)	Low	Low		Low
0 (normal priority)	Normal	Normal		High
3	Normal	Normal		
4	High	Medium		
5	High	Medium		
6	High	High		
7 (high priority)	High	High		

For example, suppose you have configured port A10 to assign a priority level of 1 (low):

- An untagged packet coming into the switch on port A10 and leaving the switch through any other port configured as a tagged VLAN member would leave the switch as a tagged packet with a priority level of 1.

- A tagged packet with an 802.1p priority setting of 0 (zero) coming into the switch on port A10 and leaving the switch through any other port configured as a tagged VLAN member would leave the switch as a tagged packet with a priority level of 1.
- A tagged packet with an 802.1p priority setting (1 - 7) coming into the switch on port A10 and leaving the switch through any other port configured as a tagged VLAN member would keep its original priority setting (regardless of the port-based priority setting on port A10).

Note

For a packet to carry a given 802.1p priority level from end-to-end in a network, the VLAN for the packet must be configured as tagged on all switch-to-switch links. Otherwise the tag is removed and the 802.1p priority is lost as the packet moves from one switch to the next.

Operating Rules for Port-Based Priority

These rules apply to the operation of port-based priority on the switch.

- In the switch's default configuration, port-based priority is configured as "0" (zero) for inbound traffic on all ports.
- On a given port, when port-based priority is configured as 0 - 7, an inbound, *untagged* packet adopts the specified priority and is sent to the corresponding outbound queue on the outbound port. (See table 10-3, "Mapping Priority Settings to Device Queues", on page 10-29.) If the outbound port is a tagged member of the applicable VLAN, then the packet carries a tag with that priority setting to the next downstream device.
- On a given port, when port-based priority is configured as 0 - 7, an inbound, *tagged* packet with a priority of 0 (zero) adopts the specified priority and is sent to the corresponding outbound queue on the outbound port. (See table 10-3, "Mapping Priority Settings to Device Queues", on page 10-29.) If the outbound port is a tagged member of the applicable VLAN, then the packet carries a tag with that priority setting to the next downstream device.
- On a given port, an inbound, *tagged* packet received on the port with a preset priority of 1 - 7 in its tag keeps that priority and is assigned an outbound queue on the basis of that priority (regardless of the port-based priority configured on the port). (Refer to table 10-3, "Mapping Priority Settings to Device Queues" on page 10-29.)
- If a packet leaves the switch through an outbound port configured as an untagged member of the packet's VLAN, then the packet leaves the switch without a VLAN tag and thus without an 802.1p priority setting.

- Trunked ports do not allow non-default (1 - 7) port-based priority settings. If you configure a non-default port-based priority value on a port and then add the port to a port trunk, then the port-based priority for that port is returned to the default “0”.

Configuring and Viewing Port-Based Priority

This command enables or disables port-based priority on a per-port basis. You can either enter the command on the interface context level or include the interface in the command.

Syntax: interface <port #> qos priority < 1 .. 7 >

Configures a non-default port-based 802.1p priority for incoming, untagged packets or tagged packets arriving with a "0" priority on the designated ports, as described under "Operating Rules for Port-Based Priority", above.

interface <port #> qos priority 0

Returns a port-based priority setting to the default “0” for untagged packets received on the designated port(s). In this state the switch handles the untagged packets with “Normal” priority. (Refer to table 10-3 on page 10-29.)

show running-config

*Lists any non-default (1 - 7) port-based priority settings in the running-config file on a per-port basis. If the priority is set to the (default) "0", the setting is not included in the **show config** listing.*

show config

*Lists any non-default (1 - 7) port-based priority settings in the startup-config file on a per-port basis. If the priority is set to the (default) "0", the setting is not included in the **show config** listing.*

For example, suppose you wanted to configure ports A10 -A12 on the switch to prioritize all untagged, inbound VLAN traffic as “Low” (priority level = 1; refer to table 10-3 on page 10-29).

```
ProCurve Switch 2810-48G(config)# int 1-3 qos priority 1
ProCurve Switch 2810-48G(config)# write mem
ProCurve Switch 2810-48G(config)# show config

Startup configuration:

; J9022A Configuration Editor; Created on release #N.10.XX

hostname "ProCurve Switch 2810-48G"
interface 1
|   qos priority 1 |
|   no lacp       |
|_exit_          |
interface 2
|   qos priority 1 |
|   no lacp       |
|_exit_          |
interface 3
|   qos priority 1 |
|_no_lacp_ _ _ _ |
|_exit_          |
```

Ports 1-3 are now configured to assign a priority level of "1" (Low) to untagged, incoming traffic. (Any inbound, tagged traffic retains its priority level while transiting the switch.)

Ports 1-3 are now configured to assign a priority level of "1" (Low) to untagged, incoming traffic. (Any inbound, tagged traffic retains its priority level while transiting the switch.)

Figure 10-16. Example of Configuring Non-Default Prioritization on Untagged, Inbound Traffic

Messages Related to Prioritization

Message	Meaning
< priority-level >: Unable to create.	The port(s) on which you are trying to configure a qos priority may belong to a port trunk. Trunked ports cannot be configured for qos priority.

Troubleshooting Prioritization

Refer to "Prioritization Problems" on page C-10 in the "Troubleshooting" chapter.

Using Friendly (Optional) Port Names

Feature	Default	Menu	CLI	Web
Configure Friendly Port Names	Standard Port Numbering	n/a	page 34	n/a
Display Friendly Port Names	n/a	n/a	page 35	n/a

This feature enables you to assign alphanumeric port names of your choosing to augment automatically assigned numeric port names. This means you can configure meaningful port names to make it easier to identify the source of information listed by some **Show** commands. (Note that this feature *augments* port numbering, but *does not replace* it.)

Configuring and Operating Rules for Friendly Port Names

- At either the global or context configuration level you can assign a unique name to any port on the switch. You can also assign the same name to multiple ports.
- The friendly port names you configure appear in the output of the **show name [port-list]**, **show config**, and **show interface <port-number>** commands. They do not appear in the output of other show commands or in Menu interface screens. (See “Displaying Friendly Port Names with Other Port Data” on page 10-35.)
- Friendly port names are not a substitute for port numbers in CLI commands or Menu displays.
- Trunking ports together does not affect friendly naming for the individual ports. (If you want the same name for all ports in a trunk, you must individually assign the name to each port.)
- A friendly port name can have up to 64 contiguous alphanumeric characters.
- Blank spaces within friendly port names are not allowed, and if used, cause an **invalid input** error. (The switch interprets a blank space as a name terminator.)
- In a port listing, **not assigned** indicates that the port does not have a name assignment other than its fixed port number.

- To retain friendly port names across reboots, you must save the current running-configuration to the startup-config file after entering the friendly port names. (In the CLI, use the **write memory** command.)

Configuring Friendly Port Names

Syntax: interface <port-list> name <port-name-string>
Assigns a port name to port-list.

no interface <port-list> name
Deletes the port name from port-list.

Configuring a Single Port Name. Suppose that you have connected port A3 on the switch to Bill Smith's workstation, and want to assign Bill's name and workstation IP address (10.25.101.73) as a port name for port A3:

```
ProCurve(config)# int e A3 name Bill_Smith@10.25.101.73
ProCurve(config)# write mem
ProCurve(config)# show name A3

Port Names
  Port : A3
  Type : 10/100TX
  Name : Bill_Smith@10.25.101.73
```

Figure 10-17. Example of Configuring a Friendly Port Name

Configuring the Same Name for Multiple Ports. Suppose that you want to use ports A5 through A8 as a trunked link to a server used by a drafting group. In this case you might configure ports A5 through A8 with the name “Draft-Server:Trunk”.

```
ProCurve(config)# int e A5-A8 name Draft-Server:Trunk
ProCurve(config)# write mem
ProCurve(config)# show name 5-8

Port Names

Port : A5
Type : 10/100TX
Name : Draft-Server:Trunk

Port : A6
Type : 10/100TX
Name : Draft-Server:Trunk

Port : A7
Type : 10/100TX
Name : Draft-Server:Trunk

Port : A8
Type : 10/100TX
Name : Draft-Server:Trunk
```

Figure 10-18. Example of Configuring One Friendly Port Name on Multiple Ports

Displaying Friendly Port Names with Other Port Data

You can display friendly port name data in the following combinations:

- **show name:** Displays a listing of port numbers with their corresponding friendly port names and also quickly shows you which ports do not have friendly name assignments. (**show name** data comes from the running-config file.)
- **show interface <port-number>:** Displays the friendly port name, if any, along with the traffic statistics for that port. (The friendly port name data comes from the running-config file.)
- **show config:** Includes friendly port names in the per-port data of the resulting configuration listing. (**show config** data comes from the startup-config file.)

To List All Ports or Selected Ports with Their Friendly Port Names.

This command lists names assigned to a specific port.

Syntax: show name [port-list]
*Lists the friendly port name with its corresponding port number and port type. The **show name** command alone lists this data for all ports on the switch.*

For example:

```
ProCurve(config)# show name
Port Names
Port Type      Name
-----
A1 10/100TX not assigned
A2 10/100TX not assigned
A3 10/100TX Bill_Smith@10.25.101.73
A4 10/100TX not assigned
A5 10/100TX Draft-Server:Trunk
A6 10/100TX Draft-Server:Trunk
A7 10/100TX Draft-Server:Trunk
A8 10/100TX Draft-Server:Trunk
A9 10/100TX not assigned
A10 10/100TX not assigned
A11 10/100TX not assigned
A12 10/100TX not assigned
:      :
:      :
```

Figure 10-19. Example of Friendly Port Name Data for All Ports on the Switch

```
ProCurve(config)# show name A2, A3, A5
Port Names
Port : A2
Type : 10/100TX
Name : not assigned
Port : A3
Type : 10/100TX
Name : Bill_Smith@10.25.101.73
Port : A5
Type : 10/100TX
Name : Draft-Server:Trunk
```

Figure 10-20. Example of Friendly Port Name Data for Specific Ports on the Switch

Including Friendly Port Names in Per-Port Statistics Listings. A friendly port name configured to a port is automatically included when you display the port's statistics output.

Syntax: show interface <port-number>
Includes the friendly port name with the port's traffic statistics listing.

For example, if you configure port A1 with the name "O'Connor_10.25.101.43", the show interface output for this port appears similar to the following:

```
ProCurve(config)# show interface A1
Status and Counters - Port Counters for port A1

Name      : O'Connor@10.25.101.43 ← Friendly Port Name

Link Status      : Up

Bytes Rx         : 894,568           Bytes Tx         : 2470
Unicast Rx      : 1179              Unicast Tx       : 13
Bcast/Mcast Rx  : 5280              Bcast/Mcast Tx   : 13

FCS Rx          : 36                Drops Tx         : 0
Alignment Rx    : 2                 Collisions Tx    : 0
Runts Rx        : 0                 Late Colln Tx   : 0
Giants Rx       : 0                 Excessive Colln : 0
Total Rx Errors : 38                Deferred Tx      : 0
```

Figure 10-21. Example of a Friendly Port Name in a Per-Port Statistics Listing

Port Status and Basic Configuration

Using Friendly (Optional) Port Names

For a given port, if a friendly port name does not exist in the running-config file, the Name line in the above command output appears as:

```
Name : not assigned
```

To Search the Configuration for Ports with Friendly Port Names.

This option tells you which friendly port names have been saved to the startup-config file. (**show config** does not include ports that have only default settings in the startup-config file.)

Syntax: show config
Includes friendly port names in a listing of all interfaces (ports) configured with non-default settings. Excludes ports that have neither a friendly port name nor any other non-default configuration settings.

For example, if you configure port A1 with a friendly port name:

```
ProCurve(config)# int e A1 name Print_Server@10.25.101.43
ProCurve(config)# write mem
ProCurve(config)# int e A2 name Herbert's_PC
ProCurve(config)# show config

Startup configuration:
; J9022A Configuration Editor; Created on release #N.10.XX
hostname "ProCurve switch"
time daylight-time-rule None
no cdp run
interface A1
  name "Print_Server@10.25.101.43"
exit

snmp-server community "public" Unrestricted
vlan 1
  name "DEFAULT_VLAN"
  untagged 1-24
  ip address dhcp-bootp
  exit
no aaa port-access authenticator active
```

This command sequence saves the friendly port name for port A1 in the startup-config file, but does not do so for the name entered for port A2.

Listing includes friendly port name for port A1 only.

In this case, **show config** lists only port A1. Executing **write mem** after entering the name for port A2, and then executing **show config** again would result in a listing that includes both

Figure 10-22. Example Listing of the Startup-Config File with a Friendly Port Name Configured (and Saved)

Port Trunking

Contents

Overview	11-2
Port Status and Configuration	11-2
Port Connections and Configuration	11-3
Link Connections	11-3
Port Trunk Options and Operation	11-3
Trunk Configuration Methods	11-4
Menu: Viewing and Configuring a Static Trunk Group	11-9
CLI: Viewing and Configuring a Static or Dynamic Port Trunk Group	11-11
Using the CLI To View Port Trunks	11-11
Using the CLI To Configure a Static or Dynamic Trunk Group	11-14
Web: Viewing Existing Port Trunk Groups	11-17
Trunk Group Operation Using LACP	11-17
Default Port Operation	11-20
LACP Notes and Restrictions	11-22
Trunk Group Operation Using the “Trunk” Option	11-24
How the Switch Lists Trunk Data	11-24
Outbound Traffic Distribution Across Trunked Links	11-25

Overview

This chapter describes creating and modifying port trunk groups. This includes non-protocol trunks and LACP (802.3ad) trunks.

Port Status and Configuration

Feature	Default	Menu	CLI	Web
viewing port trunks	n/a	page 11-9	page 11-11	page 11-17
configuring a static trunk group	none	page 11-9	page 11-15	—
configuring a dynamic LACP trunk group	LACP passive	—	page 11-15	—

Port trunking allows you to assign physical links to one logical link (trunk) that functions as a single, higher-speed link providing dramatically increased bandwidth. This capability applies to connections between backbone devices as well as to connections in other network areas where traffic bottlenecks exist.

Port Trunking Support	ProCurve 2810 Switch
Ports per trunk (maximum)	8
Trunks per switch (maximum)	24

A *trunk group* is a set of ports configured as members of the same port trunk. Note that the ports in a trunk group do not have to be consecutive. For example:

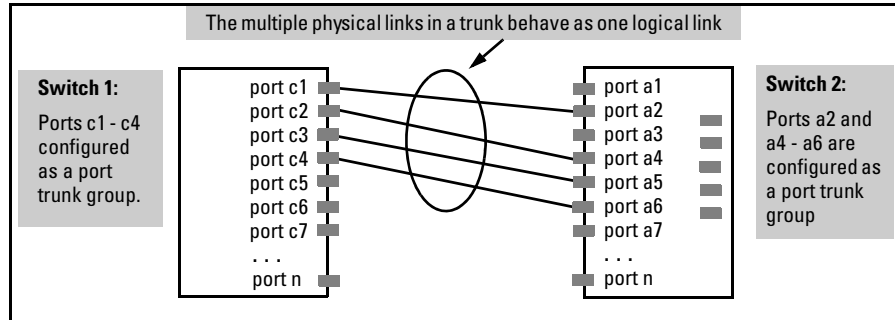

Figure 11-1. Conceptual Example of Port Trunking

Port Connections and Configuration

All port trunk links must be point-to-point connections between the switch and a router, server, workstation, or another switch configured for port trunking. No intervening, non-trunking devices are allowed. It is important to note that ports on both ends of a port trunk group must have the same mode (speed and duplex) and flow control settings.

Note

Link Connections

The switch does not support trunking through an intermediate, non-trunking device such as a hub, or using more than one media type in a port trunk group. Similarly, all links in the same trunk group must have the same speed, duplex, and flow control.

Port Trunk Options and Operation

The switch offers these options for port trunking:

- LACP (IEEE 802.3ad—page 11-17)
- Trunk (non-protocol—page 11-24)

The switch supports six trunk groups of up to four ports each. (Using the Link Aggregation Control Protocol—LACP—option, you can include standby trunked ports in addition to the maximum of four actively trunking ports.)

LACP Note

LACP operation requires full-duplex (FDx) links. For most installations, ProCurve recommends that you leave the port Mode settings at **Auto** (the default). LACP also operates with **Auto-10**, **Auto-100**, and **Auto-1000** (if negotiation selects FDx); **10FDx**, **100FDx**, and **1000FDx** settings.

Fault Tolerance: If a link in a port trunk fails, the switch redistributes traffic originally destined for that link to the remaining links in the trunk. The trunk remains operable as long as there is at least one link in operation. If a link is restored, that link is automatically included in the traffic distribution again. The LACP option also offers a standby link capability, which enables you to keep links in reserve for service if one or more of the original active links fails. See “Trunk Group Operation Using LACP” on page 11-17.)

Trunk Configuration Methods

Dynamic LACP Trunk: The switch automatically negotiates trunked links between LACP-configured ports on separate devices, and offers one dynamic trunk option: LACP. To configure the switch to initiate a dynamic LACP trunk with another device, use the **interface ethernet** command in the CLI to set the default LACP option to **Active** on the ports you want to use for the trunk. For example, the following command configures ports C1-C4 to LACP active:

```
ProCurve(config) int c1-c4 lacp active
```

Note that the above example works if the ports are not already operating in a trunk. To change the LACP option on ports already operating as a trunk, you must first disable the trunked ports that you want to reconfigure. For example, if ports C1 - C4 were LACP-active and operating in a trunk with another device, you would do the following to change them to LACP-passive:

1. Go to the port context for ports c1 - c4 and disable these ports.

```
ProCurve(config)# interface c1-c4  
ProCurve(eth-c1-c4)#_  
ProCurve(eth-c1-c4)# disable
```
2. Change all four ports to LACP-passive and re-enable the ports.

```
ProCurve(eth-c1-c4)# lacp passive  
ProCurve(eth-c1-c4)# enable
```

Note

If you change the port trunk configuration on a link, ensure that the port trunk configuration on the other end of the link matches the new configuration.

Ensure that all ports in a dynamic trunk belong to the same port group. The switches covered in this guide do not support trunks comprised of ports from different port groups. (Refer to “Trunk Group Boundary Requirement” in table 11-3 on page 11-7.)

Static Trunk: The switch uses the links you configure with the Port/Trunk Settings screen in the menu interface or the **trunk** command in the CLI to create a static port trunk. The switch offers LACP and Trunk static trunks.

Table 11-1. Trunk Types Used in Static and Dynamic Trunk Groups

Trunking Method	LACP	Trunk
Dynamic	Yes	No
Static	Yes	Yes

Table 11-2. Trunk Configuration Protocols

Protocol	Trunking Options
LACP (802.3ad)	<p>Provides dynamic and static LACP trunking options.</p> <ul style="list-style-type: none">• Dynamic LACP — Use the switch-negotiated dynamic LACP trunk when:<ul style="list-style-type: none">– The port on the other end of the trunk link is configured for Active or Passive LACP.– You want to achieve fault-tolerance for high-availability applications where you want a four-link trunk or an eight-link trunk with one or more standby links available in case an active link goes down. (Both ends of the link must be dynamic LACP.)• Static LACP — Use the manually configured static LACP trunk when:<ul style="list-style-type: none">– The port on the other end of the trunk link is configured for a static LACP trunk– You want to configure non-default spanning tree (STP) or IGMP parameters on an LACP trunk group.– You want an LACP trunk group to operate in a VLAN other than the default VLAN and GVRP is disabled. (Refer to “VLANs and Dynamic LACP” on page 11-23.)– You want to use a monitor port on the switch to monitor an LACP trunk. <p>See “Trunk Group Operation Using LACP” on page 11-17.</p>
Trunk (non-protocol)	<p>Provides manually configured, static-only trunking to:</p> <ul style="list-style-type: none">• Most ProCurve switches and routing switches not running the 802.3ad LACP protocol.• Windows NT and HP-UX workstations and servers <p>Use the Trunk option when:</p> <ul style="list-style-type: none">– The device to which you want to create a trunk link is using a non-802.3ad trunking protocol– You are unsure which type of trunk to use, or the device to which you want to create a trunk link is using an unknown trunking protocol.– You want to use a monitor port on the switch to monitor traffic on a trunk. <p>Refer to “Trunk Group Operation Using the “Trunk” Option” on page 11-24.</p>

Table 11-3. General Operating Rules for Port Trunks

Media: All ports on both ends of a trunk group must have the same media type and mode (speed and duplex). The switch blocks any trunked links that do not conform to this rule. (For the switches covered in this guide, ProCurve recommends leaving the port Mode setting at **Auto** or, in networks using Cat 3 cabling, **Auto-10**.)

Port Configuration: The default port configuration is Auto, which enables a port to sense speed and negotiate duplex with an Auto-enabled port on another device. ProCurve recommends that you use the **Auto** setting for all ports you plan to use for trunking. Otherwise, you must manually ensure that the mode setting for each port in a trunk is compatible with the other ports in the trunk.

Recommended Port Mode Setting for LACP				
<pre>ProCurve (config)# show interface config</pre>				
<pre>Port Settings</pre>				
Port	Type	Enabled	Mode	Flow Ctrl
-----	-----	+ -----	-----	-----
C1	10/100TX	Yes	Auto	Disable
C2	10/100TX	Yes	Auto	Disable

All of the following operate on a per-port basis, regardless of trunk membership:

- Enable/Disable
- Flow control (Flow Ctrl)

LACP is a full-duplex protocol. See “Trunk Group Operation Using LACP” on page 11-17.

Trunk Configuration: All ports in the same trunk group must be the same trunk type (LACP or Trunk). All LACP ports in the same trunk group must be either all static LACP or all dynamic LACP.

A trunk appears as a single port labeled **Dyn1** (for an LACP dynamic trunk) or **Trk1** (for a static trunk of any type: LACP or Trunk) on various menu and CLI screens. For a listing of which screens show which trunk types, see “How the Switch Lists Trunk Data” on page 11-24.

For STP or VLAN operation, configuration for all ports in a trunk is done at the trunk level. (You cannot separately configure individual ports within a trunk for STP or VLAN operation.)

Traffic Distribution: All of the switch trunk protocols use the SA/DA (Source Address/Destination Address) method of distributing traffic across the trunked links. See “Outbound Traffic Distribution Across Trunked Links” on page 11-25.

Port Trunking

Port Status and Configuration

Spanning Tree: Spanning Tree operates as a global setting on the switch (one instance of Spanning Tree per switch). However, you can adjust Spanning Tree parameters on a per-port basis. A static trunk of any type appears in the Spanning Tree configuration display, and you can configure Spanning Tree parameters for a static trunk in the same way that you would configure Spanning Tree parameters on a non-trunked port. (Note that the switch lists the trunk by name—such as **Trk1**—and does not list the individual ports in the trunk.) For example, if ports C1 and C2 are configured as a static trunk named **Trk1**, they are listed in the Spanning Tree display as **Trk1** and do not appear as individual ports in the Spanning Tree displays.

Port	Type	Cost	Priority	State	Designated Bridge
C3	100/1000T	5	128	Forwarding	0020c1-b27ac0
C4	100/1000T	5	128	Forwarding	0060b0-889e00
C5	100/1000T	5	128	Disabled	
C6	100/1000T	5	128	Disabled	
Trk1		1	64	Forwarding	0001e7-a0ec00

In this example showing part of the **show spanning-tree** listing, ports C1 and C2 are members of TRK1 and do not appear as individual ports in the port configuration part of the listing.

When Spanning Tree forwards on a trunk, all ports in the trunk will be forwarding. Conversely, when Spanning Tree blocks a trunk, all ports in the trunk are blocked.

Note: A dynamic LACP trunk operates only with the default Spanning Tree settings and does not appear in the Spanning Tree configuration display or **show ip igmp** listing.

If you remove a port from a static trunk, the port retains the same Spanning Tree settings that were configured for the trunk.

IP Multicast Protocol (IGMP): A static trunk of any type appears in the IGMP configuration display, and you can configure IGMP for a static trunk in the same way that you would configure IGMP on a non-trunked port. (Note that the switch lists the trunk by name—such as **Trk1**—and does not list the individual ports in the trunk.) Also, creating a new trunk automatically places the trunk in IGMP Auto status if IGMP is enabled for the default VLAN. A dynamic LACP trunk operates only with the default IGMP settings and does not appear in the IGMP configuration display or **show ip igmp** listing.

VLANs: Creating a new trunk automatically places the trunk in the DEFAULT_VLAN, regardless of whether the ports in the trunk were in another VLAN. Similarly, removing a port from a trunk group automatically places the port in the default VLAN. You can configure a static trunk in the same way that you configure a port for membership in any VLAN.

Note: For a dynamic trunk to operate in a VLAN other than the default VLAN (DEFAULT_VLAN), GVRP must be enabled. See “Trunk Group Operation Using LACP” on page 11-17.

Port Security: Trunk groups (and their individual ports) cannot be configured for port security, and the switch excludes trunked ports from the **show port-security** listing. If you configure non-default port security settings for a port, then subsequently try to place the port in a trunk, you will see the following message and the command will not be executed:

```
< port-list > Command cannot operate over a logical port.
```

Monitor Port:

Note: A trunk cannot be a monitor port. A monitor port can monitor a static trunk but cannot monitor a dynamic LACP trunk.

Menu: Viewing and Configuring a Static Trunk Group

Important

Configure port trunking *before* you connect the trunked links to another switch, routing switch, or server. Otherwise, a broadcast storm could occur. (If you need to connect the ports before configuring them for trunking, you can temporarily disable the ports until the trunk is configured. See “Using the CLI To Configure Ports” on page 10-11.)

To View and/or Configure Static Port Trunking: This procedure uses the Port/Trunk Settings screen to configure a static port trunk group on the switch.

1. Follow the procedures in the Important note above.
2. From the Main Menu, Select:
 - 2. Switch Configuration . . .**
 - 2. Port/Trunk Settings**
3. Press [E] (for **E**dit) and then use the arrow keys to access the port trunk parameters.

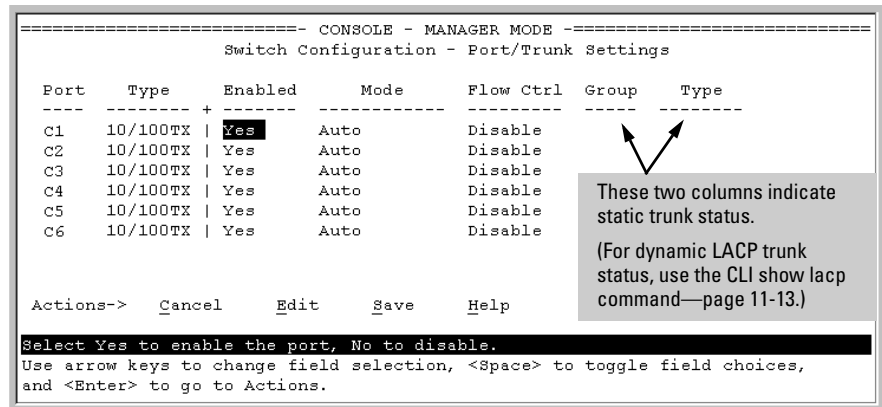

Figure 11-2. Example of the Menu Screen for Configuring a Port Trunk Group

4. In the Group column, move the cursor to the port you want to configure.
5. Use the Space bar to choose a trunk group (**Trk1**, **Trk2** . . .) trunk group assignment for the selected port.

- All ports in a trunk must have the same media type and mode (such as 10/100TX set to 100FDx, or 100FX set to 100FDx). The flow control settings must also be the same for all ports in a given trunk. To verify these settings, see “Viewing Port Status and Configuring Port Parameters” on page 10-3.
- You can configure the trunk group with one to eight ports. If multiple VLANs are configured, all ports within a trunk will be assigned to the same VLAN or set of VLANs. (With the 802.1Q VLAN capability built into the switch, more than one VLAN can be assigned to a trunk. See the chapter “Port-Based Virtual LANs (VLANs) and GVRP” in the *Advanced Traffic Management Guide*.)

(To return a port to a non-trunk status, keep pressing the Space bar until a blank appears in the highlighted Group value for that port.)

```
===== CONSOLE - MANAGER MODE =====
Switch Configuration - Port/Trunk Settings

Port   Type      Enabled  Mode      Flow Ctrl  Group  Type
-----+-----
C1     10/100TX | Yes     Auto      Disable    -----
C2     10/100TX | Yes     Auto      Disable    -----
C3     10/100TX | Yes     Auto      Disable    -----
C4     10/100TX | Yes     Auto      Disable    -----
C5     10/100TX | Yes     Auto      Disable    Trk1  Trunk
C6     10/100TX | Yes     Auto      Disable    Trk1  Trunk

Actions->  _Cancel    _Edit     _Save     _Help

Select whether the port is part of a trunk or Mesh.
Use arrow keys to change field selection, <Space> to toggle field choices,
and <Enter> to go to Actions.
```

Figure 11-3. Example of the Configuration for a Two-Port Trunk Group

6. Move the cursor to the Type column for the selected port and use the Space bar to select the trunk type:
 - LACP
 - Trunk (the default type if you do not specify a type)

All ports in the same trunk group on the same switch must have the same Type (**LACP** or **Trunk**).

7. When you are finished assigning ports to the trunk group, press **[Enter]**, then **[S]** (for **Save**) and return to the Main Menu. (It is not necessary to reboot the switch.)

During the Save process, traffic on the ports configured for trunking will be delayed for several seconds. If the Spanning Tree Protocol is enabled, the delay may be up to 30 seconds.

8. Connect the trunked ports on the switch to the corresponding ports on the opposite device. If you previously disabled any of the trunked ports on the switch, enable them now. (See “Viewing Port Status and Configuring Port Parameters” on page 10-3.)

Check the Event Log (“Using Logging To Identify Problem Sources” on page C-23) to verify that the trunked ports are operating properly.

CLI: Viewing and Configuring a Static or Dynamic Port Trunk Group

Trunk Status and Configuration Commands

show trunks	below
show lacp	page 11-13
trunk	page 11-15
interface lacp	page 11-15

Using the CLI To View Port Trunks

You can list the trunk type and group for all ports on the switch or for selected ports. You can also list LACP-only status information for LACP-configured ports.

Listing Static Trunk Type and Group for All Ports or Selected Ports.

Syntax: show trunks [<port-list>]

Omitting the < **port-list** > parameter results in a static trunk data listing for all LAN ports in the switch. For example, in a switch where ports A4 and A5 belong to Trunk 1 and ports A7 and A8 belong to Trunk 2, you have the options shown in figures 11-4 and 11-5 for displaying port data for ports belonging to static trunks.

Using a port list specifies, for switch ports in a static trunk group, only the ports you want to view. In this case, the command specifies ports A5 through A7. However, because port A6 is not in a static trunk group, it does not appear in the resulting listing:

```

Port A5 appears with an example of a name that you can optionally assign using the
Friendly PortNames feature. (See "Using Friendly (Optional) PortNames" on page 10-33.)

ProCurve> show trunks a5-a7

Load Balancing

  Port | Name | Type | Group | Type
-----+-----+-----+-----+-----
  A5   | Print-Server-Trunk | 10/100TX | Trk1 | Trunk
  A7   | not assigned | 10/100TX | Trk2 | Trunk
  
```

Port A6 does not appear in this listing because it is not assigned to a static trunk.

Figure 11-4. Example Listing Specific Ports Belonging to Static Trunks

The **show trunks <port-list>** command in the above example includes a port list, and thus shows trunk group information only for specific ports that have membership in a static trunk. In figure 11-5, the command does not include a port list, so the switch lists all ports having static trunk membership.

```

ProCurve> show trunks

Load Balancing

  Port | Name | Type | Group | Type
-----+-----+-----+-----+-----
  A4   | Print-Server-Trunk | 10/100TX | Trk1 | Trunk
  A5   | Print-Server-Trunk | 10/100TX | Trk1 | Trunk
  A7   | not assigned | 10/100TX | Trk2 | Trunk
  A8   | not assigned | 10/100TX | Trk2 | Trunk
  
```

Figure 11-5. Example of a Show Trunk Listing Without Specifying Ports

Listing Static LACP and Dynamic LACP Trunk Data. This command lists data for only the LACP-configured ports.

Syntax: show lacp

In the following example, ports A1 and A2 have been previously configured for a static LACP trunk. (For more on “Active”, see table 11-5 on page 11-21.)

```
ProCurve> show lacp
```

LACP					
PORT NUMB	LACP ENABLED	TRUNK GROUP	PORT STATUS	LACP PARTNER	LACP STATUS
----	-----	-----	-----	-----	-----
A1	Active	Trk1	Up	Yes	Success
A2	Active	Trk1	Up	Yes	Success
A3	Active	A3	Down	No	Success
A4	Passive	A4	Down	No	Success
A5	Passive	A5	Down	No	Success
A6	Passive	A6	Down	No	Success

Figure 11-6. Example of a Show LACP Listing

Dynamic LACP Standby Links. Dynamic LACP trunking enables you to configure standby links for a trunk by including more than the maximum number of allowed ports in a dynamic LACP trunk configuration. When the maximum number of allowed ports (trunk links) are up, the remaining link(s) will be held in standby status. If a trunked link that is “Up” fails, it will be replaced by a standby link, which maintains your intended bandwidth for the trunk. (See also the “Standby” entry under “Port Status” in table 11-5, "LACP Port Status Data", on page 11-21.) In the next example, ports A1 through A5 have been configured for the same dynamic LACP trunk, even though a maximum of four ports are allowed in a trunk by the switch. Notice that one of the links shows Standby status, while the remaining four links are “Up”.

```
ProCurve> show lacp
```

		LACP					
		PORT	LACP	TRUNK	PORT	LACP	LACP
		NUMB	ENABLED	GROUP	STATUS	PARTNER	STATUS
		----	-----	-----	-----	-----	-----
"Up" Links	→	A1	Active	Dyn1	Up	Yes	Success
	→	A2	Active	Dyn1	Up	Yes	Success
	→	A3	Active	Dyn1	Up	Yes	Success
	→	A4	Active	Dyn1	Up	Yes	Success
Standby Link	→	A5	Active	Dyn1	Standby	Yes	Success

Figure 11-7. Example of a Dynamic LACP Trunk with One Standby Link

Using the CLI To Configure a Static or Dynamic Trunk Group

Important

Configure port trunking *before* you connect the trunked links between switches. Otherwise, a broadcast storm could occur. (If you need to connect the ports before configuring them for trunking, you can temporarily disable the ports until the trunk is configured. See “Using the CLI To Configure Ports” on page 10-11.)

On the switches covered by this guide you can configure up to 24 port trunk groups having up to 8 links each (with additional standby links if you’re using dynamic LACP). You can configure trunk group types as follows:

Trunk Type	Trunk Group Membership	
	TrkX (Static)	DynX (Dynamic)
LACP	Yes	Yes
Trunk	Yes	No

Note

Trunks configured as FEC (Fast Ethernet Channel) are not supported. To configure port trunk groups, use static or LACP trunks. For release notes describing the latest software updates, visit the ProCurve Networking website at <http://www.procurve.com>. Click on **Technical support**, and then click on **Product manuals**.

The following examples show how to create different types of trunk groups.

Configuring a Static Trunk or Static LACP Trunk Group.

For switches covered in this guide:

Syntax: trunk <port-list> <trk1 ... trk24 > <trunk | lacp >

The following example uses ports C4 - C6 to create a non-protocol static trunk group with the group name of **Trk2**.

```
ProCurve(config)# trunk c4-c6 trk2 trunk
```

Removing Ports from a Static Trunk Group. This command removes one or more ports from an existing **Trk x** trunk group.

Caution

Removing a port from a trunk can result in a loop and cause a broadcast storm. When you remove a port from a trunk where STP is not in use, ProCurve recommends that you first disable the port or disconnect the link on that port.

Syntax: no trunk <port-list>

This example removes ports C4 and C5 from an existing trunk group.

```
ProCurve(config)# no trunk c4-c5
```

Enabling a Dynamic LACP Trunk Group. In the default port configuration, all ports on the switch are set to LACP **Passive**. However, to enable the switch to automatically form a trunk group that is dynamic on both ends of the link, the ports on one end of a set of links must be LACP **Active**. The ports on the other end can be either LACP **Active** or LACP **Passive**. This command enables the switch to automatically establish a dynamic LACP trunk group when the device ports on the other end of the link are configured for LACP **Passive**.

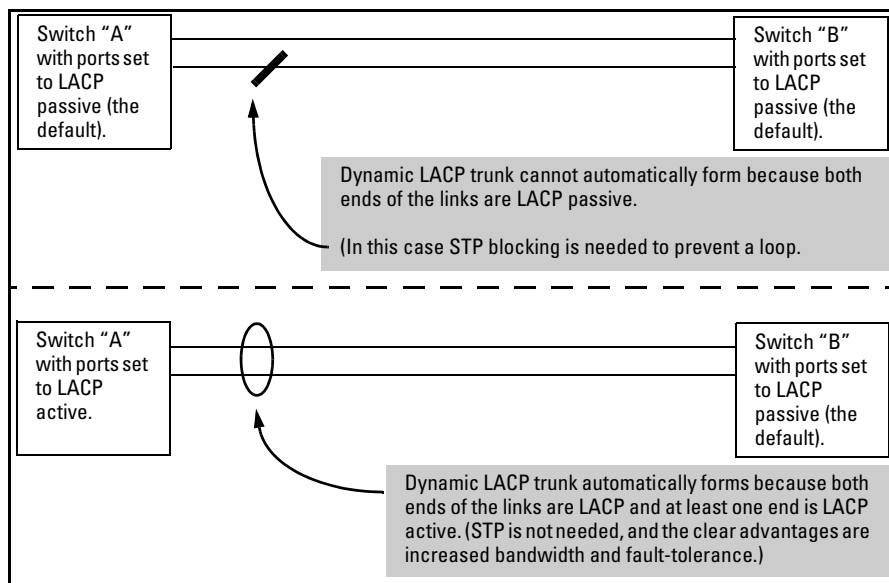

Figure 11-8. Example of Criteria for Automatically Forming a Dynamic LACP Trunk

Syntax: interface < port-list > lACP active

This example uses ports C4 and C5 to enable a dynamic LACP trunk group.

```
ProCurve(config)# interface c4-c5 lACP active
```

Removing Ports from a Dynamic LACP Trunk Group. To remove a port from dynamic LACP trunk operation, you must turn off LACP on the port. (On a port in an operating, dynamic LACP trunk, you cannot change between LACP **Active** and LACP **passive** without first removing LACP operation from the port.)

Caution

Unless STP is running on your network, removing a port from a trunk can result in a loop. To help prevent a broadcast storm when you remove a port from a trunk where STP is not in use, ProCurve recommends that you first disable the port or disconnect the link on that port.

Syntax: no interface <port-list> lacp

In this example, port C6 belongs to an operating, dynamic LACP trunk. To remove port C6 from the dynamic trunk and return it to passive LACP, you would do the following:

```
ProCurve>(config)# no interface c6 lacp  
ProCurve>(config)# interface c6 lacp passive
```

Note that in the above example, if the port on the other end of the link is configured for active LACP or static LACP, the trunked link will be re-established almost immediately.

Web: Viewing Existing Port Trunk Groups

While the web browser interface does not enable you to configure a port trunk group, it does provide a view of an existing trunk group.

To view any port trunk groups:

Click on the **Status** tab.

Click on **Port Status**.

Trunk Group Operation Using LACP

The switch can automatically configure a dynamic LACP trunk group or you can manually configure a static LACP trunk group.

Note

LACP requires full-duplex (FDx) links of the same media type (10/100Base-T, 100FX, etc.) and the same speed, and enforces speed and duplex conformance across a trunk group.

LACP trunk status commands include:

Trunk Display Method	Static LACP Trunk	Dynamic LACP Trunk
CLI show lacp command	Included in listing.	Included in listing.
CLI show trunk command	Included in listing.	Not included.
Port/Trunk Settings screen in menu interface	Included in listing.	Not included

Thus, to display a listing of dynamic LACP trunk ports, you must use the **show lacp** command.

Note

Dynamic LACP trunks operate only in the default VLAN (unless GVRP is enabled and **Forbid** is used to prevent the trunked ports from joining the default VLAN). Thus, if an LACP dynamic trunk forms using ports that are not in the default VLAN, the trunk will automatically move to the default VLAN unless GVRP operation is configured to prevent this from occurring. In some cases, this can create a traffic loop in your network. For more on this topic, refer to “VLANs and Dynamic LACP” on page 11-23.

In most cases, trunks configured for LACP operate as described in table 11-4 on the next page.

Table 11-4. LACP Trunk Types

LACP Port Trunk Configuration	Operation
Dynamic LACP	<p>This option automatically establishes an 802.3ad-compliant trunk group, with LACP for the port Type parameter and DynX for the port Group name, where X is an automatically assigned value 1 to 24 depending on how many dynamic and static trunks are currently on the switch.</p> <p>Under the following conditions, the switch automatically establishes a dynamic LACP port trunk group and assigns a port Group name:</p> <ul style="list-style-type: none"> • The ports on both ends of a link have compatible mode settings (speed and duplex). • The port on one end of a link must be configured for LACP Active and the port on the other end of the same link must be configured for either LACP Passive (the default) or LACP Active. For example: <div style="text-align: center; margin: 10px 0;"> <pre> graph LR subgraph Switch1 [Switch 1] P1[Port X: LACP Enable: Active] P2[Port Y: LACP Enable: Active] end subgraph Switch2 [Switch 2] P3[Port A: LACP Enable: Active] P4[Port B: LACP Enable: Passive] end P1 --- Active-to-Active P3 P2 --- Active-to-Passive P4 </pre> </div> <p>Either of the above link configurations allow a dynamic LACP trunk link.</p> <p>Standby Links: A maximum of eight operating links are allowed in the trunk, but, with dynamic LACP, you can configure one or more backup links that the switch automatically activates if a primary link fails. To configure a link as a standby for an existing dynamic LACP trunk, ensure that the ports in the standby link are configured the same as either of the above examples.</p> <p>Displaying Dynamic LACP Trunk Data: To list the configuration and status for a dynamic LACP trunk, use the CLI show lacp command.</p> <p style="margin-left: 40px;">Note: The dynamic trunk is automatically created by the switch, and is not listed in the static trunk listings available in the menu interface or in the CLI show trunk listing.</p>
Static LACP	<p>The trunk operates if the trunk group on the opposite device is running one of the following trunking protocols:</p> <ul style="list-style-type: none"> • Active LACP • Passive LACP • Trunk <p>This option uses LACP for the port Type parameter and TrkX for the port Group parameter, where X is an automatically assigned value from 1 to 24, depending on how many static trunks are currently operating on the switch. (The switch allows the maximum number of trunk groups in any combination of static and dynamic trunks.)</p> <p>Displaying Static LACP Trunk Data: To list the configuration and status for a static LACP trunk, use the CLI show lacp command. To list a static LACP trunk with its assigned ports, use the CLI show trunk command or display the menu interface Port/Trunk Settings screen.</p> <p>Static LACP does not allow standby ports.</p>

Default Port Operation

In the default configuration, all ports are configured for passive LACP. However, if LACP is not configured, the port will not try to detect a trunk configuration and will operate as a standard, untrunked port.

Note

Passive and active LACP port will pause and listen for LACP packets once a link is established. Once this pause is complete then the port, if a trunk is not detected, will be placed in forwarding mode. Some end-node applications have been found to be sensitive to this pause and may require LACP to be disabled on the port.

The following table describes the elements of per-port LACP operation. To display this data for a particular switch, execute the following command in the CLI:

```
ProCurve> show lacp
```

Table 11-5. LACP Port Status Data

Status Name	Meaning
Port Numb	Shows the physical port number for each port configured for LACP operation (C1, C2, C3 . . .). Unlisted port numbers indicate that the missing ports are assigned to a static Trunk group or are not configured for any trunking.
LACP Enabled	<p>Active: The port automatically sends LACP protocol packets.</p> <p>Passive: The port does not automatically send LACP protocol packets, and responds only if it receives LACP protocol packets from the opposite device.</p> <p>A link having either two active LACP ports or one active port and one passive port can perform dynamic LACP trunking. A link having two passive LACP ports will not perform LACP trunking because both ports are waiting for an LACP protocol packet from the opposite device.</p> <p>Note: In the default switch configuration, all ports are configured for passive LACP operation.</p>
Trunk Group	<p>TrkX: This port has been manually configured into a static LACP trunk.</p> <p>Trunk Group Same as Port Number: The port is configured for LACP, but is not a member of a port trunk.</p>
Port Status	<p>Up: The port has an active LACP link and is not blocked or in Standby mode.</p> <p>Down: The port is enabled, but an LACP link is not established. This can indicate, for example, a port that is not connected to the network or a speed mismatch between a pair of linked ports.</p> <p>Disabled: The port cannot carry traffic.</p> <p>Blocked: LACP, or STP has blocked the port. (The port is not in LACP Standby mode.) This may be due to a trunk negotiation (very brief) or a configuration error such as differing port speeds on the same link or attempting to connect the switch to more than the maximum number of supported trunks.</p> <p>Standby: The port is configured for dynamic LACP trunking to another device, but the maximum number of ports for the Dynamic trunk to that device has already been reached on either the switch itself or the other device. This port will remain in reserve, or “standby” unless LACP detects that another, active link in the trunk has become disabled, blocked, or down. In this case, LACP automatically assigns a Standby port, if available, to replace the failed port.</p>
LACP Partner	<p>Yes: LACP is enabled on both ends of the link.</p> <p>No: LACP is enabled on the switch, but either LACP is not enabled or the link has not been detected on the opposite device.</p>
LACP Status	<p>Success: LACP is enabled on the port, detects and synchronizes with a device on the other end of the link, and can move traffic across the link.</p> <p>Failure: LACP is enabled on a port and detects a device on the other end of the link, but is not able to synchronize with this device, and therefore not able to send LACP packets across the link. This can be caused, for example, by an intervening device on the link (such as a hub), a bad hardware connection, or if the LACP operation on the opposite device does not comply with the IEEE 802.3ad standard.</p>

LACP Notes and Restrictions

802.1X (Port-Based Access Control) Configured on a Port. To maintain security, LACP is not allowed on ports configured for 802.1X authenticator operation. If you configure port security on a port on which LACP (active or passive) is configured, the switch removes the LACP configuration, displays a notice that LACP is disabled on the port(s), and enables 802.1X on that port.

```
ProCurve(config)# aaa port-access authenticator e b1  
LACP has been disabled on 802.1X port(s).
```

The switch will not allow you to configure LACP on a port on which port access (802.1X) is enabled. For example:

```
ProCurve(config)# int b1 lacp passive  
Error configuring port < port-number >: LACP and 802.1X cannot be run  
together.
```

To restore LACP to the port, you must first remove the port's 802.1X configuration and then re-enable LACP active or passive on the port.

Port Security Configured on a Port. To maintain security, LACP is not allowed on ports configured for port security. If you configure port security on a port on which LACP (active or passive) is configured, the switch removes the LACP configuration, displays a notice that LACP is disabled on the port(s), and enables port security on that port. For example:

```
ProCurve(config)# port-security a17 learn-mode static address-limit 2  
LACP has been disabled on secured port(s).
```

The switch will not allow you to configure LACP on a port on which port security is enabled. For example:

```
ProCurve(config)# int a17 lacp passive  
Error configuring port A17: LACP and port security cannot be run together.
```

To restore LACP to the port, you must remove port security and re-enable LACP active or passive.

Changing Trunking Methods. To convert a trunk from static to dynamic, you must first eliminate the static trunk.

Static LACP Trunks. Where a port is configured for LACP (Active or Passive), but does not belong to an existing trunk group, you can add that port to a static trunk. Doing so disables dynamic LACP on that port, which means you must manually configure both ends of the trunk.

Dynamic LACP Trunks. You can configure a port for LACP-active or LACP-passive, but on a dynamic LACP trunk you cannot configure the other options that you can on static trunks. If you want to manually configure a trunk, use the **trunk** command. (Refer to “Using the CLI To Configure a Static or Dynamic Trunk Group” on page 11-14.)

VLANs and Dynamic LACP. A dynamic LACP trunk operates only in the default VLAN (unless you have enabled GVRP on the switch and use **Forbid** to prevent the ports from joining the default VLAN).

- If you want to use LACP for a trunk on a non-default VLAN and GVRP is disabled, configure the trunk as a static trunk.
- If there are ports that you do not want on the default VLAN, ensure that they cannot become dynamic LACP trunk members. Otherwise a traffic loop can unexpectedly occur. For example:

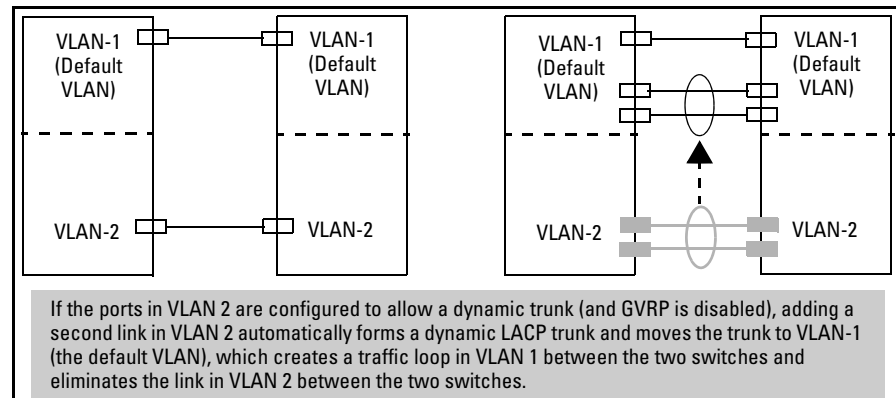

Figure 11-9. A Dynamic LACP Trunk Forming in a VLAN Can Cause a Traffic Loop

Easy control methods include either disabling LACP on the selected ports or configuring them to operate in static LACP trunks.

STP and IGMP. If spanning tree (STP) and/or IGMP is enabled in the switch, a dynamic LACP trunk operates only with the default settings for these features and does not appear in the port listings for these features.

Half-Duplex and/or Different Port Speeds Not Allowed in LACP

Trunks. The ports on both sides of an LACP trunk must be configured for the same speed and for full-duplex (FDx). The 802.3ad LACP standard specifies a full-duplex (FDx) requirement for LACP trunking.

A port configured as LACP passive and not assigned to a port trunk can be configured to half-duplex (HDx). However, in any of the following cases, a port cannot be reconfigured to an HDx setting:

- If a port is set to LACP Active, you cannot configure it to HDx.
- If a port is already a member of a static or dynamic LACP trunk, you cannot configure it to HDx.
- If a port is already set to HDx, the switch does not allow you to configure it for a static or dynamic LACP trunk.

Dynamic/Static LACP Interoperation: A port configured for dynamic LACP can properly interoperate with a port configured for static (TrkX) LACP, but any ports configured as standby LACP links will be ignored.

Trunk Group Operation Using the “Trunk” Option

This method creates a trunk group that operates independently of specific trunking protocols and does not use a protocol exchange with the device on the other end of the trunk. With this choice, the switch simply uses the SA/DA method of distributing outbound traffic across the trunked ports without regard for how that traffic is handled by the device at the other end of the trunked links. Similarly, the switch handles incoming traffic from the trunked links as if it were from a trunked source.

Use the Trunk option when you are trying to establish a trunk group between the switch and another device, but the other device’s trunking operation fails to interoperate properly with LACP trunking configured on the switch itself.

How the Switch Lists Trunk Data

Static Trunk Group: Appears in the menu interface and the output from the CLI **show trunk** and **show interfaces** commands.

Dynamic LACP Trunk Group: Appears in the output from the CLI **show lacp** command.

Interface Option	Dynamic LACP Trunk Group	Static LACP Trunk Group	Static Non-Protocol Trunk Group
Menu Interface	No	Yes	Yes
CLI:			
show trunk	No	Yes	Yes
show interfaces	No	Yes	Yes
show lacp	Yes	Yes	No
show spanning-tree	No	Yes	Yes
show igmp	No	Yes	Yes
show config	No	Yes	Yes

Outbound Traffic Distribution Across Trunked Links

Both trunk group options (LACP and Trunk) use source-destination address pairs (SA/DA) for distributing outbound traffic over trunked links.

SA/DA (source address/destination address) causes the switch to distribute outbound traffic to the links within the trunk group on the basis of source/destination address pairs. That is, the switch sends traffic from the same source address to the same destination address through the same trunked link, and sends traffic from the same source address to a different destination address through a different link, depending on the rotation of path assignments among the links in the trunk. Likewise, the switch distributes traffic for the same destination address but from different source addresses through different links. Because the amount of traffic coming from or going to various nodes in a network can vary widely, it is possible for one link in a trunk group to be fully utilized while others in the same trunk have unused bandwidth capacity even though the address assignments are evenly distributed across the links in a trunk. In actual networking environments, this is rarely a problem. However, if it becomes a problem, you can use the ProCurve Manager Plus network management software to quickly and easily identify the sources of heavy traffic (top talkers) and make adjustments to improve performance.

Broadcasts, multicasts, and floods from different source addresses are distributed evenly across the links. As links are added or deleted, the switch redistributes traffic across the trunk group. For example, in figure 11-10 showing a three-port trunk, traffic could be assigned as shown in table 11-6.

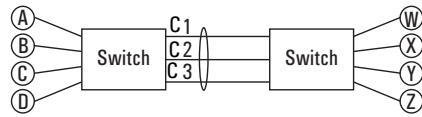

Figure 11-10. Example of Port-Trunked Network

Table 11-6. Example of Link Assignments in a Trunk Group (SA/DA Distribution)

Source:	Destination:	Link:
Node A	Node W	1
Node B	Node X	2
Node C	Node Y	3
Node D	Node Z	1
Node A	Node Y	2
Node B	Node W	3

Configuring for Network Management Applications

Contents

Using SNMP Tools To Manage the Switch	12-3
Overview	12-3
SNMP Management Features	12-4
Configuring for SNMP Access to the Switch	12-4
Configuring for SNMP Version 3 Access to the Switch	12-5
SNMP Version 3 Commands	12-6
SNMPv3 Enable	12-7
SNMP Version 3 Users	12-8
Group Access Levels	12-11
SNMP Communities	12-12
Menu: Viewing and Configuring non-SNMP version 3 Communities	12-14
CLI: Viewing and Configuring SNMP Community Names	12-16
SNMP Notification and Traps	12-18
Trap Features	12-20
Using the CLI To Enable Authentication Traps	12-23
Advanced Management: RMON	12-24
LLDP (Link-Layer Discovery Protocol)	12-25
Terminology	12-26
General LLDP Operation	12-27
Packet Boundaries in a Network Topology	12-27
Configuration Options	12-28
Options for Reading LLDP Information Collected by the Switch ..	12-30
LLDP Standards Compatibility	12-31
LLDP Operating Rules	12-31

Configuring LLDP Operation	12-32
Viewing the Current Configuration	12-32
Configuring Global LLDP Packet Controls	12-34
Configuring SNMP Notification Support	12-38
Configuring Per-Port Transmit and Receive Modes	12-39
Configuring Basic LLDP Per-Port Advertisement Content	12-40
Displaying Advertisement Data	12-42
Displaying Switch Information Available for Outbound Advertisements	12-43
Displaying LLDP Statistics	12-47
LLDP Operating Notes	12-50
LLDP and CDP Data Management	12-51
LLDP and CDP Neighbor Data	12-51
CDP Operation and Commands	12-53

Using SNMP Tools To Manage the Switch

Overview

You can manage the switch via SNMP from a network management station running an application such as ProCurve Manager (PCM) or ProCurve Manager Plus (PCM+). For more on PCM and PCM+, visit the ProCurve web site at:

<http://www.procurve.com>

Click on **products index** in the sidebar, then click on the appropriate link appearing under the **Network Management** heading.

This section includes:

- An overview of SNMP management for the switch
- Configuring the switches for:
 - SNMP Communities (page 12-12)
 - Trap Receivers and Authentication Traps (page 12-18)
- Information on advanced management through RMON Support (page 12-24)

To implement SNMP management, the switch must have an IP address, configured either manually or dynamically (using DHCP or Bootp). If multiple VLANs are configured, each VLAN interface should have its own IP address. For DHCP use with multiple VLANs, see the chapter on VLANs in the *Advanced Traffic Management Guide*.

Note

If you use the switch's Authorized IP Managers and Management VLAN features, ensure that the SNMP management station and/or the choice of switch port used for SNMP access to the switch are compatible with the access controls enforced by these features. Otherwise, SNMP access to the switch will be blocked. For more on Authorized IP Managers, refer to the *Access Security Guide* on the Documentation CD-ROM shipped with your switch. (For the latest version of this guide, visit the ProCurve web site.) For information on the Management VLAN feature, see the chapter on VLANs in the *Advanced Traffic Management Guide*.

SNMP Management Features

SNMP management features on the switch include:

- SNMP version 1, version 2c or version 3 over IP
- Security via configuration of SNMP communities (page 12-4)
- Security via authentication and privacy for SNMP Version 3 access
- Event reporting via SNMP
 - Version 1 traps
 - RMON
- ProCurve Manager/Plus support
- Flow sampling using either EASE or sFlow
- Standard MIBs, such as the Bridge MIB (RFC 1493), Ethernet MAU MIB (RFC 1515), and others

The switch SNMP agent also uses certain variables that are included in a Hewlett-Packard proprietary MIB (Management Information Base) file. To ensure that you have the latest version in the database of your SNMP network management tool, you can copy the MIB file from the ProCurve Networking web site at:

<http://www.procurve.com>

Click on **software**, then **MIBs**.

Configuring for SNMP Access to the Switch

SNMP access requires an IP address and subnet mask configured on the switch. For managed switches, ProCurve recommends permanent IP addressing. (Refer to “IP Configuration” on page 8-3.)

Once an IP address has been configured, the main steps for configuring SNMP version 1 and version 2c access management features are:

1. Configure the appropriate SNMP communities. (Refer to “SNMP Communities” on page 12-12.)
2. Configure the appropriate trap receivers. (Refer to “SNMP Notification and Traps” on page 12-18.)

In some networks, authorized IP manager addresses are not used. In this case, all management stations using the correct community name may access the switch with the View and Access levels that have been set for that community.

If you want to restrict access to one or more specific nodes, you can use the switch's IP Authorized Manager feature. (Refer to the *Access Security Guide* for your switch.)

Caution

The “public” community exists by default and is used by ProCurve’s network management applications. Deleting the “public” community disables many network management functions (such as auto-discovery, traffic monitoring, SNMP trap generation, and threshold setting). If security for network management is a concern, it is recommended that you change the write access for the “public” community to “Restricted”.

Configuring for SNMP Version 3 Access to the Switch

SNMP version 3 (SNMPv3) access requires an IP address and subnet mask configured on the switch. (See “IP Configuration” on page 8-3.) If you are using DHCP/Bootp to configure the switch, ensure that the DHCP/Bootp process provides the IP address. (See “DHCP/Bootp Operation” on page 8-12.)

Once an IP address has been configured, the main steps for configuring SNMP version 3 access management features are:

1. Enable SNMPv3 for operation on the switch (Refer to “SNMP Version 3 Commands” on page 12-6).
2. Configure the appropriate SNMP users. (Refer to “SNMP Version 3 Users” on page 12-8).
3. Configure the appropriate SNMP communities. (Refer to “SNMP Communities” on page 12-12.)
4. Configure the appropriate trap receivers. (Refer to “SNMP Notification and Traps” on page 12-18.)

In some networks, authorized IP manager addresses are not used. In this case, all management stations using the correct User and community name may access the switch with the View and Access levels that have been set for that community. If you want to restrict access to one or more specific nodes, you can use the switch's IP Authorized Manager feature. (Refer to the *Access Security Guide* for your switch.)

SNMP Version 3 Commands

SNMP version 3 (SNMPv3) adds new commands to the CLI for configuring SNMPv3 functions. You can:

- Enable SNMPv3 with the **snmpv3 enable** command. An initial user entry will be generated with MD5 authentication and DES privacy.
- Restrict access to only SNMPv3 agents with the **snmpv3 only** command.
- Restrict write access to only SNMPv3 agents with the **snmpv3 restricted-access** command

Caution

Restricting access to only version 3 messages will make the community named “public” inaccessible to network management applications (such as auto-discovery, traffic monitoring, SNMP trap generation, and threshold setting).

Syntax: [no] snmpv3 enable

Enable and disable the switch for access from SNMPv3 agents. This includes the creation of the initial user record.

[no] snmpv3 only

Enables or disables restrictions to access from only SNMPv3 agents. When enabled, the switch rejects all non-SNMPv3 messages.

[no] snmpv3 restricted-access

Enables or disables restrictions from all non-SNMPv3 agents to read only access.

show snmpv3 enable

Displays the operating status of SNMPv3.

show snmpv3 only

Displays the status of message reception of non-SNMPv3 messages.

show snmpv3 restricted-access

Displays the status of write messages of non-SNMPv3 messages.

SNMPv3 Enable

The **snmpv3 enable** command starts a dialog that performs three functions: enabling the switch to receive SNMPv3 messages, configuring the initial users, and, optionally, to restrict non version-3 messages to “read only”. Figure 12-1 shows an example of this dialog.

Note:
SNMP
Version 3
Initial Users

For most SNMPv3 management software to be able to create new users, they must have an initial user record clone. These records can be downgraded, (given fewer features), but not upgraded with new features added. For this reason ProCurve recommends that you create a second user with SHA and DES at when you enable SNMPv3

```
ProCurve (config)# snmpv3 enable
SNMPv3 Initialization process.
Creating user 'initial'
Authentication Protocol: MD5
Enter authentication password: *****
Privacy protocol is DES
Enter privacy password: *****

User 'initial' is created
Would you like to create a user that uses SHA? y
Enter user name: templateSHA
Authentication Protocol: SHA
Enter authentication password: *****
Privacy protocol is DES
Enter privacy password: *****

User creation is done.  SNMPv3 is now functional.
Would you like to restrict SNMPv1 and SNMPv2c messages to have read only
access (you can set this later by the command 'snmp restrict-access'): n
```

The diagram shows three callout boxes with arrows pointing to the terminal output:

- Enable**: Points to the `snmpv3 enable` command.
- Create initial user models for SNMPv3 management applications.**: Points to the section where the 'initial' user is created and the 'templateSHA' user is created.
- Set restriction on non-SNMPv3 messages.**: Points to the final question about restricting SNMPv1 and SNMPv2c messages.

Figure 12-1. Example of SNMP version 3 Enable Command

SNMP Version 3 Users

The second step to using SNMPv3 on the switch is to configure the users that you assign to different groups. To establish users on the switch:

- a. Add the users to the User table. This is done with the **snmpv3 user** command. To view the users in the list you use the **show snmpv3 user** command.
- b. Assign users to Security Groups based on their security model.

Caution

When stacking is enabled, SNMPv3 provides security only between an SNMPv3 management station and the stack manager. Communications between the stack commander and stack members is not secure.

Syntax: [no] snmpv3 user user_name [auth <md5 | sha><auth_pass>] [priv priv_pass]

Add or Deletes an user entry for snmpv3. Authorization and Privacy are optional, but to use privacy you must use authorization. When deleting a user only the user_name is required

[auth <md5 | sha> <auth_pass>]

With authorization you can select either md5 authentication or sha authentication. The auth_pass must be 6-32 characters in length and must be included when authentication is included. (Default: None)

[priv priv_pass]

With privacy the switch only supports DES (56-bit) encryption. The privacy password priv_pass must be 6-32 characters in length and must be included when priv is included. (Default: None)

[no] snmpv3 group group_name user user_name sec-model <ver1| ver2c | ver3>

This command assigns or removes a user to a security group for access right to the with. To delete a entry all fields must be used.

group group_name

This is the group privileges that will be assigned to the user. For more details see "Group Access Levels" on page 12-11.

(— Continued —)

```
[no] snmpv3 group group_name user user_name sec-model <ver1| ver2c  
| ver3>
```

```
user user_name
```

*This is the user to be added to the access group. This must match the user name added with the **snmpv3 user** command.*

```
sec-model <ver1 | ver2c | ver3>
```

This defines which security model to use for the added user. A SNMPv3 access Group should only use the ver3 security model.

To establish a user you must first add the user names to the list of known users. Add user names with the **snmpv3 user** CLI command.

```
ProCurve (config)# snmpv3 user NetworkAdmin
ProCurve (config)# [snmpv3 user NetworkMgr auth md5 authpass priv privpass]
```

Annotations:

- Add user NetworkAdmin with no Authentication or Privacy
- Add user Network Mgr with authentication and privacy
- Authentication is set to Md5 and the password is authpass
- Privacy is used and the password is set privpass

```
ProCurve (config)# show snmpv3 user

Status and Counters - SNMP v3 Global Configuration Information

User Name                Auth. Protocol  Privacy Protocol
-----
NetworkAdmin             None           None
NetworkMgr               MD5           des
initial                  MD5           des
templateSHA              SHA            des
```

Figure 12-2. Adding and showing Users for SNMPv3

Then you must set the group access level to the user. This is done with the **snmpv3 group** command. For more details on the MIBs access for a give group see “Group Access Levels” on page 12-11.

```
ProCurve (config)# snmpv3 group operatornoauth user NetworkAdmin sec-model ver3
ProCurve (config)# snmpv3 group managerpriv user NetworkMgr sec-model ver3
ProCurve (config)# show snmpv3 group
```

Status and Counters - SNMP v3 Global Configuration Information

Security Name	Security Model	Group Name
CommunityManagerReadOnly	ver1	ComManagerR
CommunityManagerReadWrite	ver1	ComManagerRW
CommunityOperatorReadOnly	ver1	ComOperatorRW
CommunityOperatorReadWrite	ver1	ComOperatorRW
CommunityManagerReadOnly	ver2c	ComManagerR
CommunityManagerReadWrite	ver2c	ComManagerRW
CommunityOperatorReadOnly	ver2c	ComOperatorRW
CommunityOperatorReadWrite	ver2c	ComOperatorRW
NetworkMgr	ver3	ManagerPriv
NetworkAdmin	ver3	OperatorNoAuth

Annotations:

- “Add NetworkAdmin to operator noauth group” points to the `operatornoauth` group in the configuration.
- “Add NetworkMgr to managerpriv group” points to the `managerpriv` group in the configuration.
- “Pre-assigned groups for access by Version 2c and version 1 management applications” points to the ver1 and ver2c groups in the table.

Figure 12-3. Assign Users to group for SNMPv3

Caution

Adding a user without authentication and/or privacy to a group that requires it will cause the user to not be able to access the switch. You should only add users to the group that is appropriate for their security parameters

Group Access Levels

The switch supports eight predefined group access levels. There are four levels for use with version 3 users and four are used for access by version 2c or version 1 management applications.

Group Name	Group Access Type	Group Read View	Group Write View
managerpriv	Ver3 Must have Authentication and Privacy	ManagerReadView	ManagerWriteView
managerauth	Ver3 Must have Authentication	ManagerReadView	ManagerWriteView
operatorauth	Ver3 Must have Authentication	OperatorReadView	DiscoveryView
operatornoauth	Ver3 No Authentication	OperatorReadView	DiscoveryView
commanagerrw	Ver2c or Ver1	ManagerReadView	ManagerWriteView
commanagerr	Ver2c or Ver1	ManagerReadView	DiscoveryView
comoperatorrw	Ver2c or Ver1	OperatorReadView	OperatorReadView
comoperatorr	Ver2c or Ver1	OperatorReadView	DiscoveryView

Each view allows you to view or modify a different set of MIBs.

- **Manager Read View** – access to all managed objects
- **Manager Write View** – access to all managed objects *except* the following: vacmContextTable, vacmAccessTable, vacmViewTreeFamilyTable
- **OperatorReadView** – no access to icfSecurityMIB, ProCurveIpTftp-Mode, vacmContextTable, vacmAccessTable, vacmViewTreeFamilyTable, usmUserTable, snmpCommunityTable
- **Discovery View** – Access limited to samplingProbe MIB.

Note

All access groups and views are predefined on the switch. There is no method to modify or add groups or views to those that are pre-defined on the switch.

SNMP Communities

SNMP communities are supported by the switch to allow management application that use version 2c or version 1 to access the switch. The communities are mapped to Group Access Levels that are used for version 2c or version 1 support. For more information see “Group Access Levels” on page 12-11. This mapping will happen automatically based on the communities access privileges, but special mappings can be added with the **snmpv3 community** command.

Syntax: [no] snmpv3 community

This command maps or removes a mapping of a community name to a group access level. To remove a mapping you only need the index_name.

< index < index-name >>

This is an index number or title for the mapping. The values of 1-5 are reserved and can not be mapped.

< name < com-name >>

This is the community name that is being mapped to a group access level

< sec-name < security-name >>

This is the group level that the community is being mapped. For more information see “Group Access Levels” on page 12-11.

< tag < tag-value >>

This is used to specify which target address may have access via this index reference.

Figure 12-4 shows the assigning of the Operator community on MgrStation1 to the **CommunityOperatorReadWrite** group. Any other Operator only has an access level of **CommunityOperatorReadOnly**.

```

Add mapping to allow write access for
Operator community on MgrStation1
ProCurve (config)# snmpv3 community index 30 name Operator sec-name
CommunityManagerReadWrite tag MgrStation1
ProCurve (config)# show snmpv3 community

snmpCommunityTable [rfc2576]
-----
Index Name          Community Name      Security Name
-----
1                   public              CommunityManagerReadWrite
2                   Operator            CommunityOperatorReadOnly
3                   Manager             CommunityManagerReadWrite
30                  Operator            CommunityManagerReadWrite
  
```

Two Operator Access Levels

Figure 12-4. Assigning a Community to a Group Access Level

Table 12-1. SNMP Community Features

Feature	Default	Menu	CLI	Web
show SNMP communities	n/a	page 12-14	page 12-16	—
configure identity information	none	—	page 12-17	—
configure community names	public	page 12-14	page 12-17	—
MIB view for a community name (operator, manager)	manager	"	"	"
write access for default community name	unrestricted	"	"	"

Use SNMP communities to restrict access to the switch by SNMP management stations by adding, editing, or deleting SNMP communities. You can configure up to five SNMP communities, each with either an operator-level or a manager-level view, and either restricted or unrestricted write access.

Using SNMP requires that the switch have an IP address and subnet mask compatible with your network.

Caution

Deleting or changing the community named “public” prevents network management applications (such as auto-discovery, traffic monitoring, SNMP trap generation, and threshold setting) from operating in the switch. (Changing or deleting the “public” name also generates an Event Log message.) If security for network management is a concern, it is recommended that you change the write access for the “public” community to “Restricted”.

Menu: Viewing and Configuring non-SNMP
version 3 Communities

To View, Edit, or Add SNMP Communities:

1. From the Main Menu, Select:
 - 2. Switch Configuration...**
 - 6. SNMP Community Names**

Note: This screen gives an overview of the SNMP communities that are currently configured. All fields in this screen are read-only.

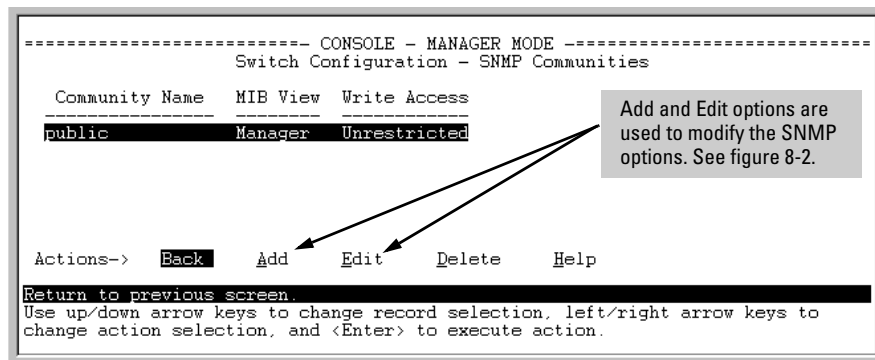

Figure 12-5. The SNMP Communities Screen (Default Values)

2. Press **[A]** (for **Add**) to display the following screen:

If you are adding a community, the fields in this screen are blank.

If you are editing an existing community, the values for the currently selected Community appear in the fields.

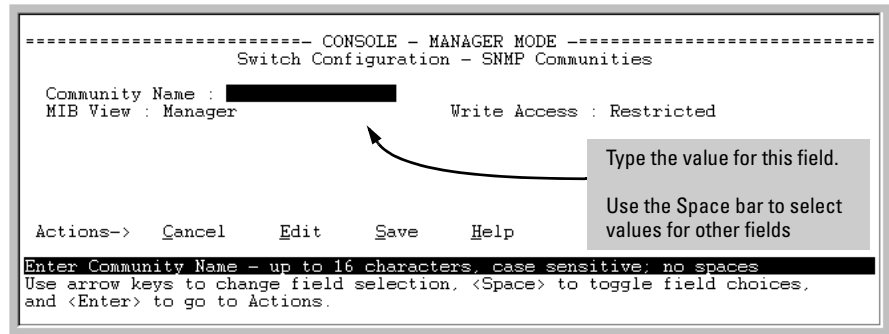

Figure 12-6. The SNMP Add or Edit Screen

Need Help? If you need information on the options in each field, press **[Enter]** to move the cursor to the Actions line, then select the **H**elp option on the Actions line. When you are finished with Help, press **[E]** (for **E**dit) to return the cursor to the parameter fields.

3. Enter the name you want in the Community Name field, and use the Space bar to select the appropriate value in each of the other fields. (Use the **[Tab]** key to move from one field to the next.)
4. Press **[Enter]**, then **[S]** (for **S**ave).

CLI: Viewing and Configuring SNMP Community Names

Community Name Commands	Page
show snmp-server [<i><community-string></i>]	12-16
[no] snmp-server	12-17
[community <i><community-str></i>]	12-17
[host <i><community-str></i> <i><ip-addr></i>] [<i><none debug all not-info critical></i>]	12-22
[enable traps <i><authentication></i>]	12-23

Listing Community Names and Values. This command lists the data for currently configured SNMP community names (along with trap receivers and the setting for authentication traps — see “SNMP Notification and Traps” on page 12-18).

Syntax: show snmp-server [*<community-string>*]

This example lists the data for all communities in a switch; that is, both the default ProCurve “public” community name and another community named “blue-team”.

```

ProCurve# show snmp-server

SNMP Communities

Community Name  MIB View  Write Access
-----
public          Manager   Unrestricted
blue-team       Operator  Restricted

Trap Receivers

Send Authentication Traps [No] : No

Address                Community      Events Sent in Trap
-----
  
```

Figure 12-7. Example of the SNMP Community Listing with Two Communities

To list the data for only one community, such as the “public” community, use the above command with the community name included. For example:

```
ProCurve# show snmp-server public
```

Configuring Community Names and Values. The **snmp-server** command enables you to add SNMP communities with either default or specific access attributes, and to delete specific communities.

Syntax: [no] snmp-server community < community-name >

*Configures a new community name. If you do not also specify **operator** or **manager**, the switch automatically assigns the community to the **operator** MIB view. If you do not specify **restricted** or **unrestricted**, the switch automatically assigns the community to **restricted** (read-only) access. The **no** form uses only the <**community-name**> variable and deletes the named community from the switch.*

[operator | manager]

*Optionally assigns an access level. At the **operator** level the community can access all MIB objects except the CONFIG MIB. At the **manager** level the community can access all MIB objects.*

[restricted | unrestricted]

*Optionally assigns MIB access type. Assigning the **restricted** type allows the community to read MIB variables, but not to set them. Assigning the **unrestricted** type allows the community to read and set MIB variables.*

For example, to add the following communities:

Community	Access Level	Type of Access
red-team	manager (Access to all MIB objects.)	unrestricted (read/write)
blue-team	operator (Access to all MIB objects except the CONFIG MIB.)	restricted (read-only)

```
ProCurve(config)# snmp-server community red-team  
manager unrestricted  
ProCurve(config)# snmp-server community blue-team  
operator restricted
```

To eliminate a previously configured community named "gold-team":

```
ProCurve(config) # no snmp-server community gold-team
```

SNMP Notification and Traps

The switches covered in this guide support the SNMPv3 notification process. They also support version 1 or version 2c traps. For more information on version 1 or version 2c traps, see “Trap Features” on page 12-20. The SNMPv3 notification process allows for the messages passed to be authenticated and encrypted if you choose. To set up a SNMPv3 notification there are three steps:

1. Establish a Notification with the **snmpv3 notify** command.
2. Point the notification to a Address with the **snmpv3 targetaddress** command.
3. Establish a parameter record for the target address with the **snmpv3 params** command.

Syntax: [no] snmpv3 notify < notify-name > [tagvalue < tag-name >]

This adds or deletes a notification request. To remove a mapping you only need the notify-name.

[no] snmpv3 targetaddress < addr-name > params < parms-name >
< IP-Addr >

Add or delete an address where notification messages are sent.

filter < none | debug | all | not-info | critical >

This filter messages to restrict type of messages transmitted to address. (Default: none)

udp-port < port >

This specifies the UDP port to use. (Default: 162)

port-mask < mask >

Used to specify a range of UDP ports. (Default: 0)

addr-mask < mask >

Used to specify a range of address to transit notify messages. (Default: 0)

retries < value >

Number times to retransmit a message when no response is reviewed. (Default: 3)

timeout < value >

How long to wait for a response for the target. (Default: 1500) (— Continued —)

```
[no] snmpv3 targetaddress <addr-name> params < params-name>  
< IP-Addr>
```

```
max-msg-size<size>
```

The maximum number of bytes of length a message to this target can be. (Default:1472)

```
taglist < tag-params>
```

*Set list of values used to select this entry from **snmpNotifyTable**.*

Note: You are only allowed up to 103 characters for this value.

```
[no] snmpv3 params < params-name> user < user-name>
```

*Add or delete a user parameter for use with target address. The params-name must match the params-name in the **targetaddress** command. The user-name should be a User from the user table. For more information on users see “SNMP Version 3 Users” on page 12-8*

*A complete **params** command must also have a sec-model and msg-processing entry.*

```
< sec-model < ver1 | ver2c | ver3 >>
```

This established the security model to use for messages passed to the targetaddress. IF ver3 is used then the msg-processing must also be ver3.

```
< msg-processing < ver1 | ver2c | ver3> [noauth | auth | priv >
```

*Establish the msg-processing for algorithm for messages passed to the target address. If **ver3** is used and **sec-model** is **ver3** then you must select a security services level (< noauth | auth | priv >)*

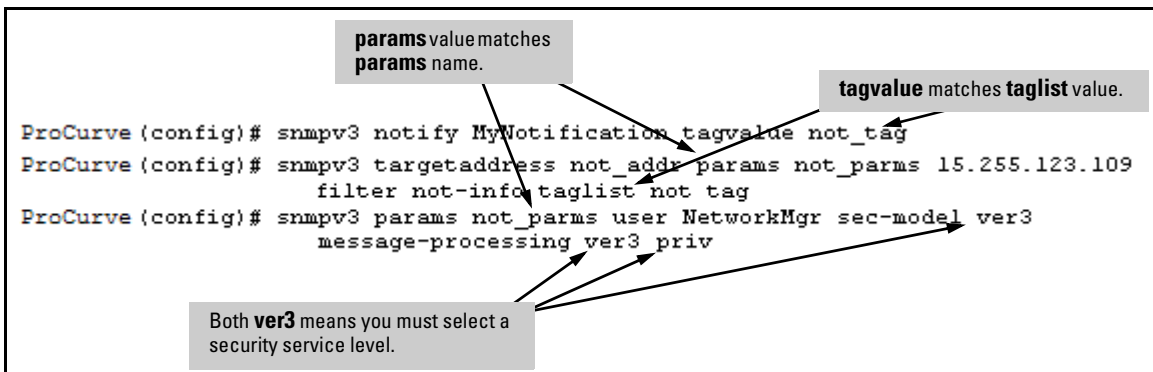

Figure 12-8. Example of SNMPv3 Configuration Session

Trap Features

Feature	Default	Menu	CLI	Web
snmp-server host (trap receiver)	public	—	page 12-22	—
snmp-server enable (authentication trap)	none	—	page 12-23	—

A *trap receiver* is a management station designated by the switch to receive SNMP traps sent from the switch. An *authentication trap* is a specialized SNMP trap sent to trap receivers when an unauthorized management station tries to access the switch.

Note

Fixed or "Well-Known" Traps: The switch automatically sends fixed traps (such as "coldStart", "warmStart", "linkDown", and "linkUp") to trap receivers using the **public** community name. These traps cannot be redirected to other communities. Thus, if you change or delete the default **public** community name, these traps will be lost.

Thresholds: The switch automatically sends all messages resulting from thresholds to the network management station(s) that set the thresholds, regardless of the trap receiver configuration.

In the default configuration, there are no trap receivers configured, and the authentication trap feature is disabled. From the CLI you can configure up to ten SNMP trap receivers to receive SNMP traps from the switch. As an option, you can also configure the switch to send Event Log messages as traps. CLI: Configuring and Displaying Trap Receivers

Trap Receiver Commands	Page
show snmp-server	12-21
snmp-server host <ip-addr> <community-name> [none all non-infol critical debug]	12-22
snmp-server enable traps authentication	12-22

Using the CLI To List Current SNMP Trap Receivers.

This command lists the currently configured trap receivers and the setting for authentication traps (along with the current SNMP community name data — see “SNMP Communities” on page 12-12).

Syntax: show snmp-server

Displays current community and trap receiver data.

In the next example, the **show snmp-server** command shows that the switch has been previously configured to send SNMP traps to management stations belonging to the “public”, “red-team”, and “blue-team” communities.

```
ProCurve# show snmp-server
```

SNMP Communities			
Community Name	MIB View	Write	Access
public	Operator	Restricted	
blue-team	Manager	Unrestricted	
red-team	Manager	Unrestricted	

Trap Receivers

Send Authentication Traps : No

Address	Community	Events Sent in Trap
10.28.227.200	public	All
10.28.227.105	red-team	Critical
10.28.227.120	blue-team	Not-INFO

Example of Community Name Data (See page 12-12.)

Example of Trap Receiver Data

Authentication Trap Setting

Figure 12-9. Example of Show SNMP-Server Listing

Configuring Trap Receivers. This command specifies trap receivers by community membership, management station IP address, and the type of Event Log messages to send to the trap receiver.

Note

If you specify a community name that does not exist—that is, has not yet been configured on the switch—the switch still accepts the trap receiver assignment. However, no traps will be sent to that trap receiver until the community to which it belongs has been configured on the switch.

Syntax: snmp-server host < community-string > < ip-address >

Using community name and destination IP address, this command designates a destination network-management station for receiving SNMP event log messages from the switch. If you do not specify the event level, then the switch does not send event log messages as traps. You can specify up to ten trap receivers (network management stations).

Note: *In all cases, the switch sends any threshold trap(s) to the network management station(s) that explicitly set the threshold(s).*

[<none | all | non-info | critical | debug>]

Options for sending switch Event Log messages to a trap receiver. Refer to Table 12-2, “Options for Sending Event Log Messages as Traps,” on page 12-22. The levels specified with these options apply only to Event Log messages, and not to threshold traps.

Table 12-2. Options for Sending Event Log Messages as Traps

Event Level	Description
None (default)	Send no log messages.
All	Send all log messages.
Not INFO	Send the log messages that are not information-only.
Critical	Send critical-level log messages.
Debug	Reserved for HP-internal use.

For example, to configure a trap receiver in a community named "red-team" with an IP address of 10.28.227.130 to receive only "critical" log messages:

```
ProCurve(config)# snmp-server trap-receiver red-team  
10.28.227.130 critical
```

Notes

To replace one community name with another for the same IP address, you must use **no snmp-server host < community-name> < ip-address >** to delete the unwanted community name. Otherwise, adding a new community name with an IP address already in use with another community name simply creates two allowable community name entries for the same management station.

If you do not specify the event level ([<none | all | non-info | critical | debug>]) then the switch does not send event log messages as traps. "Well-Known" traps and threshold traps (if configured) will still be sent.

Using the CLI To Enable Authentication Traps

Note

For this feature to operate, one or more trap receivers must be configured on the switch. See "Configuring Trap Receivers" on page 12-22.

Using the CLI To Enable Authentication Traps.

Syntax: [no] snmp-server enable traps authentication

Enables or disables sending an authentication trap to the configured trap receiver(s) if an unauthorized management station attempts to access the switch.

For example:

```
ProCurve(config)# snmp-server enable traps authentication
```

Check the Event Log in the console interface to help determine why the authentication trap was sent. (Refer to "Using Logging To Identify Problem Sources" on page C-23.)

Advanced Management: RMON

The switches covered in this guide support RMON (Remote Monitoring) on all connected network segments. This allows for troubleshooting and optimizing your network. The following RMON groups are supported:

- Ethernet Statistics (except the numbers of packets of different frame sizes)
- Alarm
- History (of the supported Ethernet statistics)
- Event

The RMON agent automatically runs in the switch. Use the RMON management station on your network to enable or disable specific RMON traps and events.

LLDP (Link-Layer Discovery Protocol)

To standardize device discovery on all ProCurve switches, LLDP has been implemented while offering limited read-only support for CDP as documented in this manual. For current information on your switch model, consult the latest Release Notes (available on the ProCurve Networking web site). If LLDP has not yet been implemented (or if you are running an older version of software), consult a previous version of the Management and Configuration Guide for device discovery details.

Table 12-3. LLDP and Features

Feature	Default	Menu	CLI	Web
View the switch's LLDP configuration	n/a	—	page 12-32	—
Enable or disable LLDP on the switch	Enabled	—	page 12-28	—
Change the transmit interval (refresh-interval) for LLDP packets	30 seconds	—	page 12-35	—
Change the holdtime multiplier for LLDP Packets (holdtime-multiplier x refresh-interval = time-to-live)	4 seconds	—	page 12-28	—
Change the delay interval between advertisements	2 seconds	—	page 12-36	—
Changing the reinitialization delay interval	2 seconds	—	page 12-37	—
Configuring SNMP notification support	Disabled	—	page 12-38	—
Configuring transmit and receive modes	tx_rx	—	page 12-39	—
Configuring basic LLDP per-port advertisement content	Enabled	—	page 12-40	—

LLDP (Link Layer Discovery Protocol): provides a standards-based method for enabling the switches covered in this guide to advertise themselves to adjacent devices and to learn about adjacent LLDP devices.

An SNMP utility can progressively discover LLDP devices in a network by:

1. Reading a given device's Neighbors table (in the Management Information Base, or MIB) to learn about other, neighboring LLDP devices.
2. Using the information learned in step 1 to find and read the neighbor devices' Neighbors tables to learn about additional devices, and so on.

Also, by using **show** commands to access the switch's neighbor database for information collected by an individual switch, system administrators can learn about other devices connected to the switch, including device type (capability) and some configuration information.

Terminology

Adjacent Device: Refer to “Neighbor or Neighbor Device”.

Advertisement: See LLDPDU.

Active Port: A port linked to another active device (regardless of whether MSTP is blocking the link).

ELIN (Emergency Location Identification Number): A valid telephone number in the North American Numbering Plan format and assigned to a multiline telephone system operator by the appropriate authority. This number calls a public service answering point (PSAP) and relays automatic location identification data to the PSAP.

LLDP: Link Layer Discovery Protocol:

- Switches covered in this guide: IEEE 802.1AB

LLDP-Aware: A device that has LLDP in its operating code, regardless of whether LLDP is enabled or disabled.

LLDP Device: A switch, server, router, or other device running LLDP.

LLDP Neighbor: An LLDP device that is either directly connected to another LLDP device or connected to that device by another, non-LLDP Layer 2 device (such as a hub) Note that an 802.1D-compliant switch does not forward LLDP data packets even if it is not LLDP-aware.

LLDPDU (LLDP Data Unit): LLDP data packet are transmitted on active links and include multiple TLVs containing global and per-port switch information. In this guide, LLDPDUs are termed “advertisements” or “packets”.

MIB (Management Information Base): An internal database the switch maintains for configuration and performance information.

MLTS (Multiline Telephone System): A network-based and/or premises-based telephone system having a common interface with the public switched telephone system and having multiple telephone lines, common control units, multiple telephone sets, and control hardware and software.

NANP (North American Numbering Plan): A ten-digit telephone number format where the first three digits are an area code and the last seven-digits are a local telephone number.

Neighbor: See “LLDP Neighbor”.

Non-LLDP Device: A device that is not capable of LLDP operation.

PD (Powered Device): This is an IEEE 802.3af-compliant device that receives its power through a direct connection to a 10/100Base-TX PoE RJ-45 port in a ProCurve fixed-port or chassis-based switch. Examples of PDs include Voice-over-IP (VoIP) telephones, wireless access points, and remote video cameras.

PSAP (Public Safety Answering Point): PSAPs are typically emergency telephone facilities established as a first point to receive emergency (911) calls and to dispatch emergency response services such as police, fire and emergency medical services.

TLV (Type-Length-Value): A data unit that includes a data type field, a data unit length field (in bytes), and a field containing the actual data the unit is designed to carry (as an alphanumeric string, a bitmap, or a subgroup of information). Some TLVs include subelements that occur as separate data points in displays of information maintained by the switch for LLDP advertisements. (That is, some TLVs include multiple data points or subelements.)

General LLDP Operation

An LLDP packet contains data about the transmitting switch and port. The switch advertises itself to adjacent (neighbor) devices by transmitting LLDP data packets out all ports on which outbound LLDP is enabled, and reading LLDP advertisements from neighbor devices on ports that are inbound LLDP-enabled. (LLDP is a one-way protocol and does not include any acknowledgement mechanism.) An LLDP-enabled port receiving LLDP packets inbound from neighbor devices stores the packet data in a Neighbor database (MIB).

Packet Boundaries in a Network Topology

- Where multiple LLDP devices are directly connected, an outbound LLDP packet travels only to the next LLDP device. An LLDP-capable device does not forward LLDP packets to any other devices, regardless of whether they are LLDP-enabled.

- An intervening hub or repeater forwards the LLDP packets it receives in the same manner as any other multicast packets it receives. Thus, two LLDP switches joined by a hub or repeater handle LLDP traffic in the same way that they would if directly connected.
- Any intervening 802.1D device or Layer-3 device that is either LLDP-unaware or has disabled LLDP operation drops the packet.

Configuration Options

Enable or Disable LLDP on the Switch. In the default configuration, LLDP is globally enabled on the switch. To prevent transmission or receipt of LLDP traffic, you can disable LLDP operation (page 12-28)

Change the Frequency of LLDP Packet Transmission to Neighbor Devices. On a global basis, you can increase or decrease the frequency of outbound LLDP advertisements (page 12-28).

Change the Time-To-Live for LLDP Packets Sent to Neighbors. On a global basis, you can increase or decrease the time that the information in an LLDP packet outbound from the switch will be maintained in a neighbor LLDP device (page 12-28).

Transmit and Receive Mode. With LLDP enabled, the switch periodically transmits an LLDP advertisement (packet) out each active port enabled for outbound LLDP transmissions, and receives LLDP advertisements on each active port enabled to receive LLDP traffic (page 12-39). Per-Port configuration options include four modes:

- Transmit and Receive (**tx_rx**): This is the default setting on all ports. It enables a given port to both transmit and receive LLDP packets, and to store the data from received (inbound) LLDP packets in the switch's MIB.
- Transmit only (**txonly**): This setting enables a port to transmit LLDP packets that can be read by LLDP neighbors. However, the port drops inbound LLDP packets from LLDP neighbors without reading them. This prevents the switch from learning about LLDP neighbors on that port.
- Receive only (**rxonly**): This setting enables a port to receive and read LLDP packets from LLDP neighbors, and to store the packet data in the switch's MIB. However, the port does not transmit outbound LLDP packets. This prevents LLDP neighbors from learning about the switch through that port.

- **Disable (disable):** This setting disables LLDP packet transmissions and reception on a port. In this state, the switch does not use the port for either learning about LLDP neighbors or informing LLDP neighbors of its presence.

SNMP Notification. You can enable the switch to send a notification to any configured SNMP trap receiver(s) when the switch detects a remote LLDP data change on an LLDP-enabled port (page 12-38).

Per-Port (Outbound) Data Options. The following table lists the information the switch can include in the per-port, outbound LLDP packets it generates. In the default configuration, all outbound LLDP packets include this information in the TLVs transmitted to neighbor devices. However, you can configure LLDP advertisements on a per-port basis to omit some of this information (page 12-40).

Table 12-4. Data Available for Basic LLDP Advertisements

Data Type	Configuration Options	Default	Description
Time-to-Live	See note 1.	120 Seconds	The length of time an LLDP neighbor retains the advertised data before discarding it.
Chassis Type ^{2, 6}	N/A	Always Enabled	Indicates the type of identifier used for Chassis ID.
Chassis ID ⁶	N/A	Always Enabled	Uses base MAC address of the switch.
Port Type ^{3, 6}	N/A	Always Enabled	Uses "Local", meaning assigned locally by LLDP.
Port Id ⁶	N/A	Always Enabled	Uses port number of the physical port. In the switches covered in this guide, this is an internal number reflecting the reserved slot/port position in the chassis. For more information on this numbering scheme, refer to figures D-2 and D-3 in Appendix D, "MAC Address Management" of the <i>Management and Configuration Guide</i> for your switch.
Remote Management Address			
Type ^{4, 6}	N/A	Always Enabled	Shows the network address type.
Address ⁴	Default or Configured	Uses a default address selection method unless an optional address is configured. See "Remote Management Address", below.	
System Name ⁶	Enable/Disable	Enabled	Uses the switch's assigned name.
System Description ⁶	Enable/Disable	Enabled	Includes switch model name and running software version, and ROM version.
Port Description ⁶	Enable/Disable	Enabled	Uses the physical port identifier.
System capabilities supported ^{5, 6}	Enable/Disable	Enabled	Identifies the switch's primary capabilities (bridge, router).

Data Type	Configuration Options	Default	Description
System capabilities enabled ^{5, 6}	Enable/Disable	Enabled	Identifies the primary switch functions that are enabled.

¹The Packet Time-to-Live value is included in LLDP data packets. (Refer to “Changing the Time-to-Live for Transmitted Advertisements” on page 12-36.)

²Subelement of the Chassis ID TLV.

³Subelement of the Port ID TLV.

⁴Subelement of the Remote-Management-Address TLV.

⁵Subelement of the System Capability TLV.

⁶Populated with data captured internally by the switch. For more on these data types, refer to the IEEE P802.1AB Standard.

Remote Management Address. The switch always includes an IP address in its LLDP advertisements. This can be either an address selected by a default process, or an address configured for inclusion in advertisements. Refer to “IP Address Advertisements” on page 12-31.

Debug Logging. You can enable LLDP debug logging to a configured debug destination (Syslog server and/or a terminal device) by executing the **debug lldp** command. (For more on Debug and Syslog, refer to the Troubleshooting appendix in the *Management and Configuration Guide* for your switch.) Note that the switch’s Event Log does not record usual LLDP update messages.

Options for Reading LLDP Information Collected by the Switch

You can extract LLDP information from the switch to identify adjacent LLDP devices. Options include:

- Using the switch’s **show lldp info** command options to display data collected on adjacent LLDP devices—as well as the local data the switch is transmitting to adjacent LLDP devices (page 12-32).
- Using an SNMP application that is designed to query the Neighbors MIB for LLDP data to use in device discovery and topology mapping.
- Using the **walkmib** command to display a listing of the LLDP MIB objects

LLDP Standards Compatibility

The operation covered by this section is compatible with these standards:

- IEEE P802.1AB
- RFC 2922 (PTOPO, or Physical Topology MIB)
- RFC 2737 (Entity MIB)
- RFC 2863 (Interfaces MIB)

LLDP Operating Rules

Port Trunking. LLDP manages trunked ports individually. That is, trunked ports are configured individually for LLDP operation, in the same manner as non-trunked ports. Also, LLDP sends separate advertisements on each port in a trunk, and not on a per-trunk basis. Similarly, LLDP data received through trunked ports is stored individually, per-port.

IP Address Advertisements. In the default operation, if a port belongs to only one static VLAN, then the port advertises the lowest-order IP address configured on that VLAN. If a port belongs to multiple VLANs, then the port advertises the lowest-order IP address configured on the VLAN with the lowest VID. If the qualifying VLAN does not have an IP address, the port advertises 127.0.0.1 as its IP address. For example, if the port is a member of the default VLAN (VID = 1), and there is an IP address configured for the default VLAN, then the port advertises this IP address. In the default operation, the IP address that LLDP uses can be an address acquired by DHCP or Bootp.

You can override the default operation by configuring the port to advertise any IP address that is manually configured on the switch, even if the port does not belong to the VLAN configured with the selected IP address (page 12-40). (Note that LLDP cannot be configured through the CLI to advertise an addresses acquired through DHCP or Bootp. However, as mentioned above, in the default LLDP configuration, if the lowest-order IP address on the VLAN with the lowest VID for a given port is a DHCP or Bootp address, then the switch includes this address in its LLDP advertisements unless another address is configured for advertisements on that port.) Also, although LLDP allows configuring multiple remote management addresses on a port, only the lowest-order address configured on the port will be included in outbound advertisements. Attempting to use the CLI to configure LLDP with an IP address that is either not configured on a VLAN, or has been acquired by DHCP or Bootp results in the following error message.

```
xxx.xxx.xxx.xxx: This IP address is not configured or is  
a DHCP address.
```

Spanning-Tree Blocking. Spanning tree does not prevent LLDP packet transmission or receipt on STP-blocked links.

802.1X Blocking. Ports blocked by 802.1X operation do not allow transmission or receipt of LLDP packets.

Configuring LLDP Operation

In the default configuration, LLDP is enabled and in both transmit and receive mode on all active ports. The LLDP configuration includes global settings that apply to all active ports on the switch, and per-port settings that affect only the operation of the specified ports.

Command	Page
show lldp config	12-34
[no] lldp run	12-35
lldp refresh-interval	12-35
lldp holdtime-multiplier	12-36
lldpTxDelay	12-36
lldpReinitDelay	12-37
lldp enable-notification	12-38
lldpnotificationinterval	12-39
lldp admin-status < txonly rxonly tx_rx disable >	12-39
lldp config < port-list > lpAddrEnable	12-40
lldp config < port-list > basicTlvEnable	12-41

Viewing the Current Configuration

Displaying the Global LLDP, Port Admin, and SNMP Notification Status. This command displays the switch's general LLDP configuration status, including some per-port information affecting advertisement traffic and trap notifications.

Syntax show lldp config

Displays the LLDP global configuration, LLDP port status, and SNMP notification status. For information on port admin status, refer to "Configuring Per-Port Transmit and Receive Modes" on page 12-39.

For example, **show lldp config** produces the following display when the switch is in the default LLDP configuration:

```
ProCurve(config)# show lldp config

LLDP Global Configuration

LLDP Enabled [Yes] : Yes
LLDP Transmit Interval [30] : 30
LLDP Hold time Multiplier [4] : 4
LLDP Delay Interval [2] : 2
LLDP Reinit Interval [2] : 2
LLDP Notification Interval [5] : 5

LLDP Port Configuration
```

Port	AdminStatus	NotificationEnabled	Med Topology Trap Enabled
1	Tx_Rx	False	False
2	Tx_Rx	False	True
3	Tx_Rx	False	False
4	Tx_Rx	False	False
5	Tx_Rx	False	True
6	Tx_Rx	False	False
7	Tx_Rx	False	False
8	Tx_Rx	False	False
.	.	.	
.	.	.	

Note: This value corresponds to the lldp refresh-interval command (page 12-35).

Figure 12-10. Example of Viewing the General LLDP Configuration

Displaying Port Configuration Details. This command displays the port-specific configuration, including.

Syntax show lldp config < port-list >

Displays the LLDP port-specific configuration for all ports in < port-list>, including which optional TLVs and any non-default IP address that are included in the port's outbound advertisements. For information on the notification setting, refer to "Configuring SNMP Notification Support" on page 12-38. For information on the other configurable settings displayed by this command, refer to "Configuring Per-Port Transmit and Receive Modes" on page 12-39.

```
ProCurve(config)# show lldp config a1

LLDP Port Configuration Detail

Port : a1
AdminStatus [Tx_Rx] : Tx_Rx
NotificationEnabled [False] : False
Med Topology Trap Enabled [False] : False

TLVS Advertised:
 * port_descr
 * system_name
 * system_descr
 * system_cap

[ * capabilities
  * network_policy |
  * location_id   |
  * poe           |
  * _ _ _ _ _ _ _ ]
[ * macphy_config ]

IpAddress Advertised:
```

These fields appear when medtlvenable is enabled on the switch, which is the default setting.

This field appears when dot3tlvenable is enabled on the switch, which is the default setting.

The blank IpAddress field indicates that the default IP address will be advertised from this port. (Refer to page 12-40: "Configuring a Remote Management Address for Outbound LLDP Advertisements")

Figure 12-11. Example of Per-Port Configuration Display

Configuring Global LLDP Packet Controls

The commands in this section configure the aspects of LLDP operation that apply the same to all ports in the switch.

Enabling or Disabling LLDP Operation on the Switch. Enabling LLDP operation (the default) causes the switch to:

- Use active, LLDP-enabled ports to transmit LLDP packets describing itself to neighbor devices.
- Add entries to its neighbors table based on data read from incoming LLDP advertisements.

Syntax [no] lldp run

*Enables or disables LLDP operation on the switch. The **no** form of the command, regardless of individual LLDP port configurations, prevents the switch from transmitting outbound LLDP advertisements, and causes the switch to drop all LLDP advertisements received from other devices. The switch preserves the current LLDP configuration when LLDP is disabled. After LLDP is disabled, the information in the LLDP neighbors database remains until it times-out. (Default: Enabled)*

For example, to disable LLDP on the switch:

```
ProCurve(config)# no lldp run
```

Changing the Packet Transmission Interval. This interval controls how often active ports retransmit advertisements to their neighbors.

Syntax lldp refresh-interval < 5 - 32768 >

Changes the interval between consecutive transmissions of LLDP advertisements on any given port. (Default: 30 seconds)

Note: The **refresh-interval** must be greater than or equal to (4 x **delay-interval**). (The default **delay-interval** is 2). For example, with the default **delay-interval**, the lowest **refresh-interval** you can use is 8 seconds (4 x 2 = 8). Thus, if you want a **refresh-interval** of 5 seconds, you must first change the delay interval to 1 (that is, 4 x 1 < 5). If you want to change the **delay-interval**, use the **setmib** command.

Changing the Time-to-Live for Transmitted Advertisements. The Time-to-Live value (in seconds) for all LLDP advertisements transmitted from a switch is controlled by the switch that generates the advertisement, and determines how long an LLDP neighbor retains the advertised data before discarding it. The Time-to-Live value is the result of multiplying the **refresh-interval** by the **holdtime-multiplier** described below.

Syntax `lldp holdtime-multiplier < 2 - 10 >`

Changes the multiplier an LLDP switch uses to calculate the Time-to-Live for the LLDP advertisements it generates and transmits to LLDP neighbors. When the Time-to-Live for a given advertisement expires the advertised data is deleted from the neighbor switch's MIB. (Default: 4; Range: 2 - 10)

For example, if the refresh-interval on the switch is 15 seconds and the **holdtime-multiplier** is at the default, the Time-to-Live for advertisements transmitted from the switch is 60 seconds (4 x 15). To reduce the Time-to-Live, you could lower the **holdtime-interval** to 2, which would result in a Time-to-Live of 30 seconds.

```
ProCurve(config)# lldp holdtime-multiplier 2
```

Changing the Delay Interval Between Advertisements Generated by Value or Status Changes to the LLDP MIB. The switch uses a *delay-interval* setting to delay transmitting successive advertisements resulting from these LLDP MIB changes. If a switch is subject to frequent changes to its LLDP MIB, lengthening this interval can reduce the frequency of successive advertisements. The delay-interval can be changed using either an SNMP network management application or the CLI **setmib** command.

Syntax `setmib lldpTxDelay.0 -i < 1 - 8192 >`

Uses **setmib** to change the minimum time (delay-interval) any LLDP port will delay advertising successive LLDP advertisements due to a change in LLDP MIB content. (Default: 2; Range: 1 - 8192)

Note: The LLDP refresh-interval (transmit interval) must be greater than or equal to (4 x delay-interval). The switch does not allow increasing the delay interval to a value that conflicts with this relationship. That is, the switch displays **Inconsistent value** if (4 x delay-interval) exceeds the current transmit interval, and the command fails. Depending on the current refresh-interval setting, it may be necessary to increase the refresh-interval before using this command to increase the delay-interval.

For example, to change the delay-interval from 2 seconds to 8 seconds when the refresh-interval is at the default 30 seconds, you must first set the refresh-interval to a minimum of 32 seconds ($32 = 4 \times 8$).

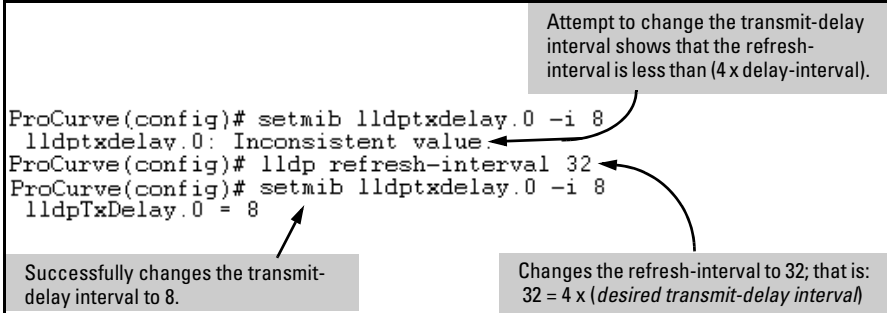

```
ProCurve(config)# setmib lldptxdelay.0 -i 8
lldptxdelay.0: Inconsistent value.
ProCurve(config)# lldp refresh-interval 32
ProCurve(config)# setmib lldptxdelay.0 -i 8
lldpTxDelay.0 = 8
```

Attempt to change the transmit-delay interval shows that the refresh-interval is less than (4 x delay-interval).

Successfully changes the transmit-delay interval to 8.

Changes the refresh-interval to 32; that is: $32 = 4 \times (\text{desired transmit-delay interval})$

Figure 12-12. Example of Changing the Transmit-Delay Interval

Changing the Reinitialization Delay Interval. In the default configuration, a port receiving a **disable** command followed immediately by a **txonly**, **rxonly**, or **tx_rx** command delays reinitializing for two seconds, during which time LLDP operation remains disabled. If an active port is subjected to frequent toggling between the LLDP disabled and enabled states, LLDP advertisements are more frequently transmitted to the neighbor device. Also, the neighbor table in the adjacent device will change more frequently, as it deletes, then replaces LLDP data for the affected port which, in turn, generates SNMP traps (if trap receivers and SNMP notification are configured). All of this can unnecessarily increase network traffic. Extending the reinitialization-

delay interval delays the port's ability to reinitialize and generate LLDP traffic following an LLDP disable/enable cycle.

Syntax `setmib lldpReinitDelay.0 -i < 1 - 10 >`

*Uses **setmib** to change the minimum time (reinitialization delay interval) an LLDP port will wait before reinitializing after receiving an LLDP disable command followed closely by a `txonly` or `tx_rx` command. The delay interval commences with execution of the **lldp admin-status < port-list > disable** command. (Default: 2 seconds; Range: 1 - 10 seconds)*

For example, the following command changes the reinitialization delay interval to five seconds:

```
ProCurve(config)# setmib lldpreinitdelay.0 -i 5
```

Configuring SNMP Notification Support

You can enable SNMP trap notification of LLDP data changes detected on advertisements received from neighbor devices, and control the interval between successive notifications of data changes on the same neighbor.

Enabling LLDP Data Change Notification for SNMP Trap Receivers.

Syntax `[no] lldp enable-notification < port-list >`

Enables or disables each port in < port-list > for sending notification to configured SNMP trap receiver(s) if an LLDP data change is detected in an advertisement received on the port from an LLDP neighbor. (Default: Disabled)

For information on configuring trap receivers in the switch, refer to the chapter titled "Configuring for Network Management Applications" in the Management and Configuration Guide for your switch.

For example, this command enables SNMP notification on ports 1 - 5:

```
ProCurve(config)# lldp enable-notification 1-5
```

Changing the Minimum Interval for Successive Data Change Notifications for the Same Neighbor.

If LLDP trap notification is enabled on a port, a rapid succession of changes in LLDP information received in advertisements from one or more neighbors can generate a high number of traps. To reduce this effect, you can globally change the interval between successive notifications of neighbor data change.

Syntax `setmib lldpnotificationinterval.0 -i < 1 - 3600 >`

Globally changes the interval between successive traps generated by the switch. If multiple traps are generated in the specified interval, only the first trap will be sent. The remaining traps will be suppressed. (A network management application can periodically check the switch MIB to detect any missed change notification traps. Refer to IEEE P802.1AB or later for more information.) (Default: 5 seconds)

For example, the following command limits change notification traps from a particular switch to one per minute.

```
ProCurve(config)# setmib lldpnotificationinterval.0 -i 60  
lldpNotificationInterval.0 = 60
```

Configuring Per-Port Transmit and Receive Modes

These commands control advertisement traffic inbound and outbound on active ports.

Syntax `lldp admin-status < port-list > < txonly | rxonly | tx_rx | disable >`

With LLDP enabled on the switch in the default configuration, each port is configured to transmit and receive LLDP packets. These options enable you to control which ports participate in LLDP traffic and whether the participating ports allow LLDP traffic in only one direction or in both directions.

txonly: *Configures the specified port(s) to transmit LLDP packets, but block inbound LLDP packets from neighbor devices.*

rxonly: *Configures the specified port(s) to receive LLDP packets from neighbors, but block outbound packets to neighbors.*

tx_rx: *Configures the specified port(s) to both transmit and receive LLDP packets. (This is the default setting.)*

disable: *Disables LLDP packet transmit and receive on the specified port(s).*

Configuring Basic LLDP Per-Port Advertisement Content

In the default LLDP configuration, outbound advertisements from each port on the switch include both mandatory and optional data.

Mandatory Data. An active LLDP port on the switch always includes the mandatory data in its outbound advertisements. LLDP collects the mandatory data, and, except for the Remote Management Address, you cannot use LLDP commands to configure the actual data.

- Chassis Type (TLV subelement)
- Chassis ID (TLV)
- Port Type (TLV subelement)
- Port ID (TLV)
- Remote Management Address (TLV; actual IP address is a subelement that can be a default address or a configured address)

Configuring a Remote Management Address for Outbound LLDP Advertisements. This is an optional command you can use to include a specific IP address in the outbound LLDP advertisements for specific ports.

Syntax [no] lldp config < port-list > ipAddrEnable < ip-address >

*Replaces the default IP address for the port with an IP address you specify. This can be any IP address configured in a static VLAN on the switch, even if the port does not belong to the VLAN configured with the selected IP address. The **no** form of the command deletes the specified IP address. If there are no IP addresses configured as management addresses, then the IP address selection method returns to the default operation. (Default: The port advertises the IP address of the lowest-numbered VLAN (VID) to which it belongs. If there is no IP address configured on the VLAN(s) to which the port belongs, and the port is not configured to advertise an IP address from any other (static) VLAN on the switch, then the port advertises an address of 127.0.0.1.)*

Note: This command does not accept either IP addresses acquired through DHCP or Bootp, or IP addresses that are not configured in a static VLAN on the switch

For example, if port 3 belongs to a subnetted VLAN that includes an IP address of 10.10.10.100 and you wanted port 3 to use this secondary address in LLDP advertisements, you would need to execute the following command:

```
ProCurve(config)# lldp config 3 ipAddrEnable 10.10.10.100
```

Optional Data. You can configure an individual port or group of ports to exclude one or more of these data types from outbound LLDP advertisements. Note that optional data types, when enabled, are populated with data internal to the switch; that is, you cannot use LLDP commands to configure their actual content.

- port description (TLV)
- system name (TLV)
- system description (TLV)
- system capabilities (TLV)
 - system capabilities Supported (TLV subelement)
 - system capabilities Enabled (TLV subelement)
- port speed and duplex (TLV subelement)

Syntax: [no] lldp config < port-list > basicTlvEnable < TLV-Type >

port_descr

*For outbound LLDP advertisements, this TLV includes an alphanumeric string describing the port.
(Default: Enabled)*

system_name

*For outbound LLDP advertisements, this TLV includes an alphanumeric string showing the system's assigned name.
(Default: Enabled)*

system_descr

*For outbound LLDP advertisements, this TLV includes an alphanumeric string describing the full name and version identification for the system's hardware type, software version, and networking application.
(Default: Enabled)*

system_cap

*For outbound advertisements, this TLV includes a bitmask of supported system capabilities (device functions). Also includes information on whether the capabilities are enabled.
(Default: Enabled)*

For example, if you wanted to exclude the system name TLV from the outbound LLDP advertisements for all ports on a switch, you would use this command:

```
ProCurve(config)# no lldp config 1-24 basicTlvEnable  
system_name
```

If you later decided to reinstate the system name TLV on ports 1-5, you would use this command:

```
ProCurve(config)# lldp config 1-5 basicTlvEnable  
system_name
```

Displaying Advertisement Data

Command	Page
show lldp info local-device	below
show lldp info remote-device	12-44
show lldp info stats	12-47

Displaying Switch Information Available for Outbound Advertisements

These commands display the current switch information that will be used to populate outbound LLDP advertisements.

Syntax `show lldp info local-device [port-list]`

Without the [port-list] option, this command displays the global switch information and the per-port information currently available for populating outbound LLDP advertisements.

With the [port-list] option, this command displays only the following port-specific information that is currently available for outbound LLDP advertisements on the specified ports:

- **PortType**
- **PortId**
- **PortDesc**

Note: *This command displays the information available on the switch. Use the `lldp config < port-list >` command to change the selection of information that is included in actual outbound advertisements. In the default LLDP configuration, all information displayed by this command is transmitted in outbound advertisements.*

For example, in the default configuration, the switch information currently available for outbound LLDP advertisements appears similar to the display in figure 12-13 on page page 12-44.

```

ProCurve(config)# show lldp info local-device

LLDP Local Device Information

Chassis Type : mac-address
Chassis Id   : 00 08 83 08 db 20
System Name  : HPswitch
System Description : J4900A ProCurve Switch 2626, revision I.08.51, RO...
System Capabilities Supported : bridge, router
System Capabilities Enabled   : bridge
Management Address :
|  Type:ipv4          | ←
|  Address: _ _ _ _ _|

LLDP Port Information

Port      | PortType  PortId  PortDesc
-----+-----+-----+-----
1         | local     1       1
2         | local     2       2
3         | local     3       3
4         | local     4       4
5         | local     5       5
6         | local     6       6
.         | .         .       .
.         | .         .       .
.         | .         .       .
  
```

The Management Address field displays only the LLDP-configurable IP addresses on the switch. (Only manually-configured IP addresses are LLDP-configurable.) If the switch has only an IP address from a DHCP or Bootp server, then the Management Address field is empty (because there are no LLDP-configurable IP addresses available). For more on this topic, refer to "Remote Management Address" on page 12-30.

Figure 12-13. Example of Displaying the Global and Per-Port Information Available for Outbound Advertisements

```

ProCurve(config)# show lldp info local 1-2

LLDP Local Port Information Detail

Port      : 1
PortType  : local
PortId    : 1
PortDesc  : 1
-----
Port      : 2
PortType  : local
PortId    : 2
PortDesc  : 2
  
```

Figure 12-14. Example of the Default Per-Port Information Content for Ports 1 and 2

Displaying Advertisements Currently in the Neighbors MIB. These commands display the content of the inbound LLDP advertisements received from other LLDP devices. These commands can also display the content of inbound CDP advertisements. (For more on how the switches handle data received in CDP advertisements, refer to "LLDP and CDP Data Management" on page 12-51).

Syntax show lldp info remote-device [*port-list*]

*Without the [**port-list**] option, this command provides a global list of the individual devices it has detected by reading LLDP advertisements (and also CDP advertisements). Discovered devices are listed by the inbound port on which they were discovered.*

Multiple devices listed for a single port indicates either or both of the following:

- A discovered device is transmitting both LLDP and CDP packets with different chassis and port ID information.*
- Multiple devices are connected to the switch through a hub.*

Discovering the same device on multiple ports indicates that the remote device may be connected to the switch in one of the following ways:

- Through different VLANs using separate links. (This applies to switches that use the same MAC address for all configured VLANs.)*
- Through different links in the same trunk.*
- Through different links using the same VLAN. (In this case, spanning-tree should be invoked to prevent a network topology loop. Note that LLDP packets travel on links that spanning-tree blocks for other traffic types.)*

*With the [**port-list**] option, this command provides a listing of the LLDP data that the switch has detected in advertisements received on the specified ports. If neighbor data is read from CDP advertisements, the switch remaps this information into the switch's LLDP neighbors MIB in addition to the CDP Neighbors MIB.*

For descriptions of the various types of information displayed by these commands, refer to Table 12-4 on page 12-29.

Configuring for Network Management Applications

LLDP (Link-Layer Discovery Protocol)

```
ProCurve # show lldp info remote

LLDP Remote Devices Information

LocalPort | ChassisId                PortId PortName SysName
-----+-----
1         | 00 11 85 c6 54 60        17    17    ProCurve Switch ...
2         | 00 11 85 cf 66 80        33    33    ProCurve Switch ...

The data shown for port 3 was translated from a
CDP advertisement from a 5300xl switch with
LLDP disabled. (Not all fields expected by the
LLDP device are populated with the CDP data.)
```

Figure 12-15. Example of a Global Listing of Discovered Devices

```
ProCurve(config)# show lldp info remote-device 1

LLDP Remote Device Information Detail

Local PortName:1
ChassisType   : mac-address
ChassisId    : 00 11 0a 50 28 80
PortType     : local
PortId       : 1
SysName      : HP ProCurve Switch 3400cl-48G
System Descr : HP J4906A ProCurve Switch 3400cl-48G, revision M.08.51, R...
PortDescr    : 1
SystemCapSupported : bridge, router
SystemCapEnabled  : bridge
Remote ManagementAddress
  Type:ipv4
  Address:10.10.10.102

Example of an LLDP advertisement received
from a 3400cl-48G neighbor on port 1.
```

Figure 12-16. Example of a Per-Port Listing of Advertisements Received from an LLDP Device

Note

With both LLDP and (read-only) CDP enabled on a switch port, the port can read both LLDP and CDP advertisements, and stores both types of data in its neighbor database. (When reading CDP advertisements, the switch only stores data that has a corresponding field in the LLDP neighbor database.)

Displaying LLDP Statistics

LLDP statistics are available on both a global and a per-port levels. Rebooting the switch resets the LLDP statistics counters to zero. Disabling the transmit and/or receive capability on a port “freezes” the related port counters at their current values.

Syntax `show lldp info stats [port-list]`

The global LLDP statistics command displays an overview of neighbor detection activity on the switch, plus data on the number of frames sent, received, and discarded per-port. The per-port LLDP statistics command enhances the list of per-port statistics provided by the global statistics command with some additional per-port LLDP statistics.

Global LLDP Counters:

Neighbor Entries List Last Updated: *Shows the elapsed time since a neighbor was last added or deleted.*

New Neighbor Entries Count: *Shows the total of new LLDP neighbors detected since the last switch reboot. Disconnecting, then reconnecting a neighbor increments this counter.*

Neighbor Entries Deleted Count: *Shows the number of neighbor deletions from the MIB for AgeOut Count and forced drops for all ports. For example, if the admin status for port on a neighbor device changes from **tx_rx** or **txonly** to **disabled** or **rxonly**, then the neighbor device sends a “shutdown” packet out the port and ceases transmitting LLDP frames out that port. The device receiving the shutdown packet deletes all information about the neighbor received on the applicable inbound port and increments the counter .*

Neighbor Entries Dropped Count: *Shows the number of valid LLDP neighbors the switch detected, but could not add. This can occur, for example, when a new neighbor is detected when the switch is already supporting the maximum number of neighbors. Refer to “Neighbor Maximum” on page 12-50.*

Neighbor Entries AgeOut Count: *Shows the number of LLDP neighbors dropped on all ports due to Time-to-Live expiring.*

— Continued on the next page. —

— Continued from the preceding page. —

Per-Port LLDP Counters:

NumFramesRecvd: Shows the total number of valid, inbound LLDP advertisements received from any neighbor(s) on < port-list >. Where multiple neighbors are connected to a port through a hub, this value is the total number of LLDP advertisements received from all sources.

NumFramesSent: Shows the total number of LLDP advertisements sent from < port-list >.

NumFramesDiscarded: Shows the total number of inbound LLDP advertisements discarded by < port-list >. This can occur, for example, when a new neighbor is detected on the port, but the switch is already supporting the maximum number of neighbors. Refer to “Neighbor Maximum” on page 12-50. This can also be an indication of advertisement formatting problems in the neighbor device.

Frames Invalid: Shows the total number of invalid LLDP advertisements received on the port. An invalid advertisement can be caused by header formatting problems in the neighbor device.

TLVs Unrecognized: Shows the total number of LLDP TLVs received on a port with a type value in the reserved range. This could be caused by a basic management TLV from a later LLDP version than the one currently running on the switch.

TLVs Discarded: Shows the total number of LLDP TLVs discarded for any reason. In this case, the advertisement carrying the TLV may be accepted, but the individual TLV was not usable.

Neighbor Ageouts: Shows the number of LLDP neighbors dropped on the port due to Time-to-Live expiring.

```
ProCurve(config)# show lldp stats

LLDP Device Statistics

Neighbor Entries List Last Updated : 2 hours
New Neighbor Entries Count : 20
Neighbor Entries Deleted Count : 20
Neighbor Entries Dropped Count : 0
Neighbor Entries AgeOut Count : 20

LLDP Port Statistics
```

Port	NumFramesRecvd	NumFramesSent	NumFramesDiscarded
1	628	316	0
2	21	12	0
3	0	252	0
4	446	226	0
5	0	0	0
6	0	0	0
.	.	.	.
.	.	.	.
.	.	.	.

Counters showing frames sent on a port but no frames received on that port indicates an active link with a device that either has LLDP disabled on the link or is not LLDP-aware.

Figure 12-17. Example of a Global LLDP Statistics Display

```
ProCurve(config)# show lldp stats 1

LLDP Port Statistics Detail

PortName : 1
Frames Discarded : 0
Frames Invalid : 0
Frames Received : 658
Frames Sent : 331
TLVs Unrecognized : 0
TLVs Discarded : 0
Neighbor Ageouts : 0
```

Figure 12-18. Example of a Per-Port LLDP Statistics Display

LLDP Operating Notes

Neighbor Maximum. The neighbors table in the switch supports as many neighbors as there are ports on the switch. The switch can support multiple neighbors connected through a hub on a given port, but if the switch neighbor maximum is reached, advertisements from additional neighbors on the same or other ports will not be stored in the neighbors table unless some existing neighbors time-out or are removed.

LLDP Packet Forwarding: If CDP is globally disabled on a switch, the switch forwards CDP packets received from a neighbor CDP device instead of reading and dropping them. However, an 802.1D-compliant switch does not forward LLDP packets, regardless of whether LLDP is globally enabled or disabled on the switch.

One IP Address Advertisement Per-Port: LLDP advertises only one IP address per-port, even if multiple IP addresses are configured by `lldp config < port-list > ipAddrEnable` on a given port.

802.1Q VLAN Information. LLDP packets do not include 802.1Q header information, and are always handled as untagged packets.

Effect of 802.1X Operation. If 802.1X port security is enabled on a port and a connected device is not authorized, LLDP packets are not transmitted or received on that port. Any neighbor data stored in the neighbor MIB for that port prior to the unauthorized device connection remains in the MIB until it ages out. If an unauthorized device later becomes authorized, LLDP transmit and receive operation resumes.

Neighbor Data Can Remain in the Neighbor Database After the Neighbor Is Disconnected. After disconnecting a neighbor LLDP device from the switch, the neighbor can continue to appear in the switch's neighbor database for an extended period if the neighbor's **holdtime-multiplier** is high; especially if the **refresh-interval** is large. Refer to "Changing the Time-to-Live for Transmitted Advertisements" on page 12-36.

LLDP and CDP Data Management

This section describes points to note regarding LLDP (Link-Layer Discovery Protocol) and CDP (Cisco Discovery Protocol) data received by the switch from other devices. LLDP operation includes both transmitting LLDP packets to neighbor devices and reading LLDP packets received from neighbor devices. CDP operation is limited to reading incoming CDP packets from neighbor devices. (ProCurve switches do not generate CDP packets.)

LLDP and CDP Neighbor Data

With both LLDP and (read-only) CDP enabled on a switch port, the port can read both LLDP and CDP advertisements, and stores the data from both types of advertisements in its neighbor database. (The switch only *stores* CDP data that has a corresponding field in the LLDP neighbor database.) The neighbor database itself can be read by either LLDP or CDP methods or by using the **show lldp** commands. Take note of the following rules and conditions:

- If the switch receives both LLDP and CDP advertisements on the same port from the same neighbor the switch stores this information as two separate entries if the advertisements have differences chassis ID and port ID information.
- If the chassis and port ID information are the same, the switch stores this information as a single entry. That is, LLDP data overwrites the corresponding CDP data in the neighbor database if the chassis and port ID information in the LLDP and CDP advertisements received from the same device is the same.
- Data read from a CDP packet does not support some LLDP fields, such as “System Descr”, “SystemCapSupported”, and “ChassisType”. For such fields, LLDP assigns relevant default values. Also:
 - The LLDP “System Descr” field maps to CDP’s “Version” and “Platform” fields.
 - The switch assigns “ChassisType” and “PortType” fields as “local” for both the LLDP and the CDP advertisements it receives.
 - Both LLDP and CDP support the “System Capability” TLV. However, LLDP differentiates between what a device is capable of supporting and what it is actually supporting, and separates the two types of information into subelements of the System Capability TLV. CDP has only a single field for this data. Thus, when CDP System Capability data is mapped to LLDP, the same value appears in both LLDP System Capability fields.
 - System Name and Port Descr are not communicated by CDP, and thus are not included in the switch’s Neighbors database.

Note

Because ProCurve switches do not generate CDP packets, they are not represented in the CDP data collected by any neighbor devices running CDP.

A switch with CDP disabled forwards the CDP packets it receives from other devices, but does not store the CDP information from these packets in its own MIB.

LLDP data transmission/collection and CDP data collection are both enabled in the switch's default configuration. In this state, an SNMP network management application designed to discover devices running either CDP or LLDP can retrieve neighbor information from the switch regardless of whether LLDP or CDP is used to collect the device-specific information.

Protocol State	Packet Generation	Inbound Data Management	Inbound Packet Forwarding
CDP Enabled ¹	n/a	Store inbound CDP data.	No forwarding of inbound CDP packets.
CDP Disabled	n/a	No storage of CDP data from neighbor devices.	Floods inbound CDP packets from connected devices to outbound ports.
LLDP Enabled ¹	Generates and transmits LLDP packets out all ports on the switch.	Store inbound LLDP data.	No forwarding of inbound LLDP packets.
LLDP Disabled	No packet generation.	No storage of LLDP data from neighbor devices.	No forwarding of inbound LLDP packets.

¹Both CDP data collection and LLDP transmit/receive are enabled in the default configuration. If a switch receives CDP packets and LLDP packets from the same neighbor device on the same port, it stores and displays the two types of information separately if the chassis and port ID information in the two types of advertisements is different. In this case, if you want to use only one type of data from a neighbor sending both types, disable the unwanted protocol on either the neighbor device or on the switch. However, if the chassis and port ID information in the two types of advertisements is the same, the LLDP information overwrites the CDP data for the same neighbor device on the same port.

CDP Operation and Commands

By default the switches covered by this guide have CDP enabled on each port. This is a read-only capability, meaning that the switch can receive and store information about adjacent CDP devices but does not generate CDP packets.

When a CDP-enabled switch receives a CDP packet from another CDP device, it enters that device's data in the CDP Neighbors table, along with the port number where the data was received (and does not forward the packet). The switch also periodically purges the table of any entries that have expired. (The hold time for any data entry in the switch's CDP Neighbors table is configured in the device transmitting the CDP packet, and cannot be controlled in the switch receiving the packet.) A switch reviews the list of CDP neighbor entries every three seconds, and purges any expired entries.

Command	Page
show cdp	12-53
show cdp neighbors [< port-list > detail] [detail < port-list >]	12-54
[no] cdp run	12-55
[no] cdp enable < port-list >	12-55

Note

For details on how to use an SNMP utility to retrieve information from the switch's CDP Neighbors table maintained in the switch's MIB (Management Information Base), refer to the documentation provided with the particular SNMP utility.

Viewing the Switch's Current CDP Configuration. CDP is shown as enabled/disabled both globally on the switch and on a per-port basis.

Syntax: show cdp

Lists the switch's global and per-port CDP configuration.

The following example shows the default CDP configuration.

```
ProCurve(config)# show cdp
Global CDP information
  Enable CDP [Yes] : Yes
Port CDP
-----
A1  enabled
A2  enabled
A3  enabled
  .
  .
  .
```

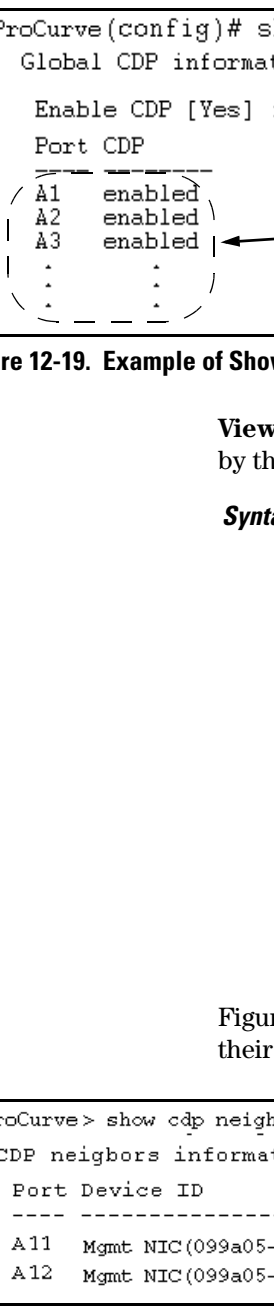

Figure 12-19. Example of Show CDP with the Default CDP Configuration

Viewing the Switch's Current CDP Neighbors Table. Devices are listed by the port on which they were detected.

Syntax: show cdp neighbors

Lists the neighboring CDP devices the switch detects, with a subset of the information collected from the device's CDP packet.

[port-numb [detail]]

*Lists the CDP device connected to the specified port. (Allows only one port at a time.) Using **detail** provides a longer list of details on the CDP device the switch detects on the specified port.*

[detail [port-num]]

Provides a list of the details for all of the CDP devices the switch detects. Using port-num produces a list of details for the selected port.

Figure 12-20 lists two CDP devices that the switch has detected by receiving their CDP packets.

```
ProCurve> show cdp neighbors
CDP neighbors information
-----+-----
Port Device ID | Platform | Capability
-----+-----
A11 Mgmt NIC(099a05-09df9b) | NIC Model X666 | H
A12 Mgmt NIC(099a05-09df11) | NIC Model X666 | H
```

Figure 12-20. Example of CDP Neighbors Table Listing

Enabling CDP Operation. Enabling CDP operation (the default) on the switch causes the switch to add entries to its CDP Neighbors table for any CDP packets it receives from other neighboring CDP devices.

Disabling CDP Operation. Disabling CDP operation clears the switch's CDP Neighbors table and causes the switch to drop inbound CDP packets from other devices without entering the data in the CDP Neighbors table.

Syntax: [no] cdp run

*Enables or disables read-only CDP operation on the switch.
(Default: Enabled)*

For example, to disable CDP read-only operation on the switch:

```
ProCurve(config)# no cdp run
```

When CDP is disabled:

- **show cdp neighbors** displays an empty CDP Neighbors table
- **show cdp** displays

```
Global CDP information  
Enable CDP [Yes]: No
```

Enabling or Disabling CDP Operation on Individual Ports. In the factory-default configuration, the switch has all ports enabled to receive CDP packets. Disabling CDP on a port causes it to drop inbound CDP packets without recording their data in the CDP Neighbors table.

Syntax: [no] cdp enable <port-list>

For example, to disable CDP on port A1:

```
ProCurve(config)# no cdp enable a1
```

Configuring for Network Management Applications
LLDP (Link-Layer Discovery Protocol)

File Transfers

Contents

Overview	A-2
Downloading Switch Software	A-2
General Switch Software Download Rules	A-3
Using TFTP To Download Switch Software from a Server	A-3
Menu: TFTP Download from a Server to Primary Flash	A-4
CLI: TFTP Download from a Server to Primary or Secondary Flash	A-6
Using Secure Copy and SFTP	A-7
How It Works	A-8
The SCP/SFTP Process	A-9
Command Options	A-9
Authentication	A-10
SCP/SFTP Operating Notes	A-10
Using Xmodem to Download Switch Software From a PC or UNIX Workstation	A-11
Menu: Xmodem Download to Primary Flash	A-12
CLI: Xmodem Download from a PC or Unix Workstation to Primary or Secondary Flash	A-13
Switch-to-Switch Download	A-14
Menu: Switch-to-Switch Download to Primary Flash	A-14
CLI: Switch-To-Switch Downloads	A-15
Using ProCurve Manager Plus to Update Switch Software	A-16
Troubleshooting TFTP Downloads	A-17
Transferring Switch Configurations	A-18
Copying Diagnostic Data to a Remote Host, PC, or Unix Workstation .	A-21
Copying Command Output to a Destination Device	A-21
Copying Event Log Output to a Destination Device	A-22
Copying Crash Data Content to a Destination Device	A-22
Copying Crash Log Data Content to a Destination Device	A-23

Overview

You can download new switch software and upload or download switch configuration files. These features are useful for acquiring periodic switch software upgrades and for storing or retrieving a switch configuration.

This appendix includes the following information:

- Downloading switch software (begins below)
- Transferring switch configurations (begins on page A-18)

For information on how switch memory operates, including primary and secondary flash, see Chapter 6, “Switch Memory and Configuration”.

Note

In the switch console interface, the switch software is referred to as the OS, for switch “operating system”.

Downloading Switch Software

ProCurve Networking periodically provides switch software updates through the ProCurve website (<http://www.procurve.com>). For more information, see the support and warranty booklet shipped with the switch. After you acquire a new switch software file, you can use one of the following methods for downloading the switch software code to the switch:

Switch Software Download Features

Feature	Default	Menu	CLI	Web
TFTP	n/a	page A-4	page A-6	—
Xmodem	n/a	page A-12	page A-13	—
Switch-to-Switch	n/a	page A-14	page A-15	
Software Update Manager in ProCurve Manager Plus	Refer to the documentation provided with ProCurve Manager Plus.			

General Switch Software Download Rules

- A switch software image downloaded through the menu interface always goes to primary flash.
- After a switch software download, you must reboot the switch to implement the newly downloaded code. Until a reboot occurs, the switch continues to run on the software it was using before the download started.

Note

Downloading new switch software does not change the current switch configuration. The switch configuration is contained in separate files that can also be transferred. Refer to “Transferring Switch Configurations” on page A-18.

In most cases, if a power failure or other cause interrupts a flash image download, the switch reboots with the image previously stored in primary flash. In the unlikely event that the primary image is corrupted (which may occur if a download is interrupted by a power failure), the switch goes into boot ROM mode. In this case, use the boot ROM console to download a new switch software image to primary flash. Refer to “Restoring a Flash Image” on page C-44.

Using TFTP To Download Switch Software from a Server

This procedure assumes that:

- An switch software file for the switch has been stored on a TFTP server accessible to the switch. (The switch software file is typically available from the ProCurve website at <http://www.procurve.com>.)
- The switch is properly connected to your network and has already been configured with a compatible IP address and subnet mask.
- The TFTP server is accessible to the switch through IP.

Before you use the procedure, do the following:

- Obtain the IP address of the TFTP server in which the switch software file has been stored.
- If VLANs are configured on the switch, determine the name of the VLAN in which the TFTP server is operating.
- Determine the name of the switch software file stored in the TFTP server for the switch (for example, **N0721.swi**).

Note

If your TFTP server is a Unix workstation, *ensure that the case (upper or lower) that you specify for the filename is the same case as the characters in the switch software filenames on the server.*

Menu: TFTP Download from a Server to Primary Flash

Note that the menu interface accesses only the primary flash.

1. In the console Main Menu, select **Download OS** to display this screen:

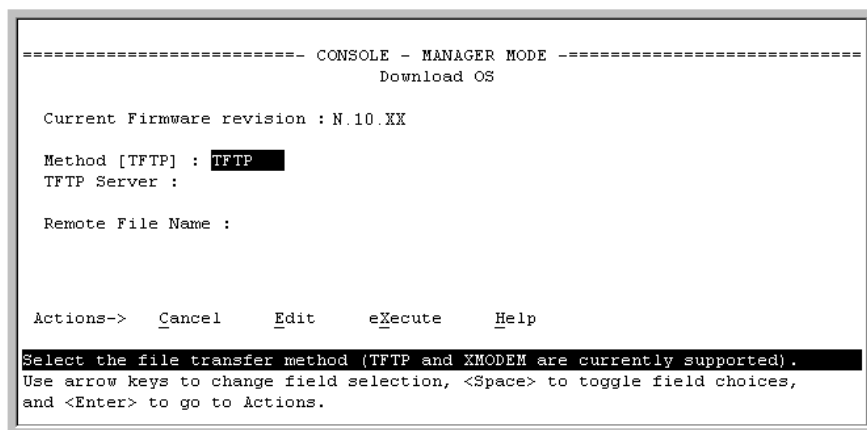

```
----- CONSOLE - MANAGER MODE -----
                          Download OS

Current Firmware revision : N.10.XX

Method [TFTP] : TFTP
TFTP Server :
Remote File Name :

Actions->  _Cancel      _Edit      eXecute      _Help

Select the file transfer method (TFTP and XMODEM are currently supported).
Use arrow keys to change field selection, <Space> to toggle field choices,
and <Enter> to go to Actions.
```

Figure A-1. Example of the Download OS Screen (Default Values)

2. Press **[E]** (for **Edit**).
3. Ensure that the **Method** field is set to **TFTP** (the default).
4. In the **TFTP Server** field, type in the IP address of the TFTP server in which the switch software file has been stored.
5. In the **Remote File Name** field, type the name of the switch software file. If you are using a UNIX system, remember that the filename is case-sensitive.
6. Press **[Enter]**, then **[X]** (for **eXecute**) to begin the switch software download. The following screen then appears:

```
----- CONSOLE - MANAGER MODE -----
                          Download OS
Current Firmware revision : N.10.XX
Method [TFTP] : TFTP
TFTP Server : 13.28.227.105

Remote File Name : G_05_02.swi

Received 370,000 bytes of OS download.
+-----+
|*****|
+-----+
```

Figure A-2. Example of the Download OS Screen During a Download

A “progress” bar indicates the progress of the download. When the entire switch software file has been received, all activity on the switch halts and you will see **Validating and writing system software to FLASH...**

7. After the primary flash memory has been updated with the new switch software, you must reboot the switch to implement the newly downloaded code. From the Main Menu and press **[6]** (for **Reboot Switch**). You will then see this prompt:

```
Continue reboot of system? : No
```

Press the space bar once to change No to Yes, then press **[Enter]** to begin the reboot.

Note

When you use the menu interface to download switch software, the new image is always stored in primary flash. Also, using the **Reboot Switch** option in the Main Menu always reboots the switch from primary flash. Rebooting the switch from the CLI gives you more options. Refer to “Rebooting the Switch” on page 6-17.

8. After you reboot the switch, confirm that the switch software downloaded correctly:
 - a. From the Main Menu, select **1. Status and Counters**, and from the Status and Counters menu, select **1. General System Information**
 - b. Check the **Firmware revision** line.
 - c. From the CLI, use the command **show version** or **show flash**.

CLI: TFTP Download from a Server to Primary or Secondary Flash

This command automatically downloads a switch software image to primary or secondary flash.

Syntax: `copy tftp flash < ip-address > < remote-os-file > [< primary | secondary >]`

Note that if you do not specify the flash destination, the Xmodem download defaults to primary flash.

For example, to download a switch software file named `N_10_XX_A_031706.swi` from a TFTP server with the IP address of `10.28.227.103` to primary flash:

1. Execute **copy** as shown below:

```
ProCurve(config)# copy tftp flash 10.28.227.103 N_10_XX_A_031706.swi
The Primary OS Image will be deleted, continue [y/n] ? y
01431K
```

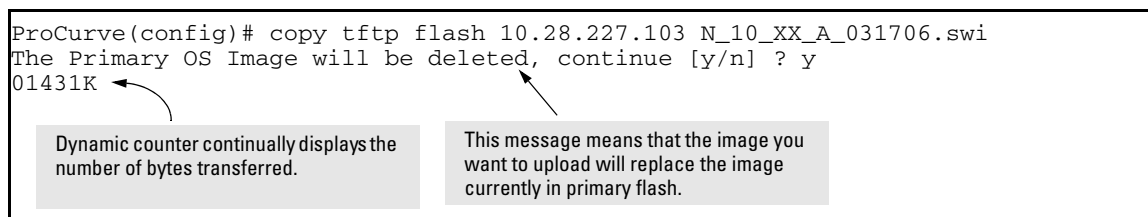

Dynamic counter continually displays the number of bytes transferred.

This message means that the image you want to upload will replace the image currently in primary flash.

Figure A-3. Example of the Command to Download Switch Software

2. When the switch finishes downloading the switch software file from the server, it displays this progress message:

Validating and Writing System Software to FLASH . . .

3. When the switch is ready to activate the downloaded software you will see this message:

System software written to FLASH.

You will need to reboot to activate.

At this point, use the `boot` command to reboot the switch and activate the software you just downloaded:

```
ProCurve # boot
```

(For more on these commands, refer to “Rebooting the Switch” on page 6-17.)

4. To confirm that the switch software downloaded correctly, execute **show system** and check the Firmware revision line.

If you need information on primary/secondary flash memory and the boot commands, refer to “Using Primary and Secondary Flash Image Options” on page 6-12.

Using Secure Copy and SFTP

For some situations you may want to use a secure method to issue commands or copy files to the switch. By opening a secure, encrypted SSH session you can then use a third-party software application to take advantage of Secure Copy (SCP) and Secure ftp (SFTP). SCP and SFTP provide a secure alternative to TFTP for transferring information that may be sensitive (like switch configuration files) to and from the switch. Essentially you are creating a secure SSH tunnel as a way to transfer files with SFTP and SCP channels.

To use these commands you must install on the administrator workstation a third-party application software client that supports the SFTP and/or SCP functions. Some examples of software that supports SFTP and SCP are PuTTY, Open SSH, WinSCP, and SSH Secure Shell. Most of these are freeware and may be downloaded without cost or licensing from the internet. There are differences in the way these clients work, so be sure you also download the documentation.

As described earlier in this chapter you can use a TFTP client on the administrator workstation to update software images. This is a plain text mechanism and it connects to a standalone TFTP server or another ProCurve switch acting as a TFTP server to obtain the software image file(s). Using SCP and SFTP allows you to maintain your switches with greater security. You can also roll out new software images with automated scripts that make it easier to upgrade multiple switches simultaneously and securely.

SFTP (secure file transfer protocol) is unrelated to FTP, although there are some functional similarities. Once you set up an SFTP session through an SSH tunnel, some of the commands are the same as FTP commands. Certain commands are not allowed by the SFTP server on the switch, such as those that create files or folders. If you try to issue commands such as **create** or **remove** using SFTP the switch server returns an error message.

You can use SFTP just as you would TFTP to transfer files to and from the switch, but with SFTP your file transfers are encrypted and require authentication, so they are more secure than they would be using TFTP. SFTP works only with SSH version 2 (SSH v2).

Note

SFTP over SSH version 1 (SSH v1) is not supported. A request from either the client or the switch (or both) using SSH v1 generates an error message. The actual text of the error message differs, depending on the client software in use. Some examples are:

```
Protocol major versions differ: 2 vs. 1  
Connection closed
```

```
Protocol major versions differ: 1 vs. 2  
Connection closed
```

```
Received disconnect from <ip-addr>: /usr/local/  
libexec/sftp-server: command not supported  
Connection closed
```

SCP (secure copy) is an implementation of the BSD **rcp** (Berkeley UNIX remote copy) command tunneled through an SSH connection.

SCP is used to copy files to and from the switch when security is required. SCP works with both SSH v1 and SSH v2. Be aware that the most third-party software application clients that support SCP use SSHv1.

How It Works

The general process for using SCP and SFTP involves three steps:

1. Open an SSH tunnel between your computer and the switch if you haven't already done so. (This step assumes that you have already set up SSH on the switch.)
2. Execute **ip ssh filetransfer** to tell the switch that you want to enable secure file transfer.
3. Use a third-party client application for SCP and SFTP commands.

The SCP/SFTP Process

To use SCP and SFTP:

1. Open an SSH session as you normally would to establish a secure encrypted tunnel between your computer and the switch. For more detailed directions on how to open an SSH session see the chapter titled “*Configuring Secure Shell (SSH)*” in the *Access Security Guide* for your switch. Please note that this is a one-time procedure for new switches or connections. If you have already done it once you should not need to do it a second time.
2. To enable secure file transfer on the switch (once you have an SSH session established between the switch and your computer), open a terminal window and type in the following command:

```
ProCurve(config)# ip ssh filetransfer
```

Command Options

If you need to enable SSH v2 (which is required for SFTP) enter this command:

```
ProCurve(config)# ip ssh version 2
```

Note

As a matter of policy, administrators should *not* enable the SSHv1-only or the SSHv1-or-v2 advertisement modes. SSHv1 is supported on only some legacy switches (such as the ProCurve Series 2500 switches).

To confirm that SSH is enabled type in the command

```
ProCurve(config)# show ip ssh
```

3. Once you have confirmed that you have enabled an SSH session (with the **show ip ssh** command) you can then open your third-party software client application to begin using the SCP or SFTP commands to safely transfer files or issue commands to the switch.

If you need to disable secure file transfer:

```
ProCurve(config)# no ip ssh filetransfer
```

Authentication

Switch memory allows up to ten public keys. This means the authentication and encryption keys you use for your third-party client SCP/SFTP software can differ from the keys you use for the SSH session, even though both SCP and SFTP use a secure SSH tunnel.

Note

SSH authentication through a TACACS+ server and use of SCP or SFTP through an SSH tunnel are mutually exclusive. Thus, if the switch is configured to use TACACS+ for authenticating a secure Telnet SSH session on the switch, you cannot enable SCP or SFTP. Also, if SCP or SFTP is enabled on the switch, you cannot enable TACACS+ authentication for a secure Telnet SSH. The switch displays a message similar to the following if there is an attempt to configure either option when the other is already configured:

```
RADIUS/TACACS authentication for ssh sessions and  
secure file transfer(scp/sftp) may not be configured  
simultaneously.
```

To provide username/password authentication on a switch providing SCP or SFTP support, use the switch's local username/password facility. Otherwise, you can use the switch's local public key for authentication.

Some clients such as PSCP (PuTTY SCP) automatically compare switch host keys for you. Other clients require you to manually copy and paste keys to the **\$HOME/.ssh/known_hosts** file. Whatever SCP/SFTP software tool you use, after installing the client software you must verify that the switch host keys are available to the client.

Because the third-party software utilities you may use for SCP/SFTP vary, you should refer to the documentation provided with the utility you select before performing this process.

SCP/SFTP Operating Notes

- When an SFTP client connects, the switch provides a file system displaying all of its available files and folders. No file or directory creation is permitted by the user. Files may only be uploaded or downloaded, according to the permissions mask. All of the necessary files the switch will need are already in place on the switch. You do not need to (nor can you create) new files.
- The switch supports one SFTP session or one SCP session at a time.

- All files have read-write permission. Several SFTP commands, such as create or remove, are not allowed and return an error message. The switch displays the following files:

```
/
+---cfg
|   running-config
|   startup-config
+---log
|   crash-data
|   crash-log
|   event log
+---os
|   primary
|   secondary
\---ssh
    +---mgr_keys
    |   authorized_keys
    \---oper_keys
        authorized_keys
```

Once you have configured your switch for secure file transfers with SCP and SFTP, files can be copied to or from the switch in a secure (encrypted) environment and TFTP is no longer necessary.

Using Xmodem to Download Switch Software From a PC or UNIX Workstation

This procedure assumes that:

- The switch is connected via the Console RS-232 port to a PC operating as a terminal. (Refer to the *Installation and Getting Started Guide* you received with the switch for information on connecting a PC as a terminal and running the switch console interface.)
- The switch software is stored on a disk drive in the PC.
- The terminal emulator you are using includes the Xmodem binary transfer feature. (For example, in the HyperTerminal application included with Windows NT, you would use the **Send File** option in the **Transfer** dropdown menu.)

Menu: Xmodem Download to Primary Flash

Note that the menu interface accesses only the primary flash.

1. From the console Main Menu, select
 - 7. Download OS**
2. Press **[E]** (for **E**dit).
3. Use the Space bar to select **XMODEM** in the **Method** field.
4. Press **[Enter]**, then **[X]** (for **eXecute**) to begin the switch software download. The following message then appears:

**Press enter and then initiate Xmodem transfer
from the attached computer.....**

5. Press **[Enter]** and then execute the terminal emulator command(s) to begin Xmodem binary transfer. For example, using HyperTerminal:
 - a. Click on **Transfer**, then **Send File**.
 - b. Type the file path and name in the Filename field.
 - c. In the Protocol field, select **Xmodem**.
 - d. Click on the **Send** button.

The download will then commence. It can take several minutes, depending on the baud rate set in the switch and in your terminal emulator.

6. After the primary flash memory has been updated with the new operating system, you must reboot the switch to implement the newly downloaded software. Return to the Main Menu and press **[6]** (for **Reboot Switch**). You will then see this prompt:

```
Continue reboot of system? : No
```

Press the space bar once to change No to Yes, then press **[Enter]** to begin the reboot.

7. To confirm that the switch software downloaded correctly:
 - a. From the Main Menu, select
 - 1. Status and Counters**
 - 1. General System Information**
 - b. Check the **Firmware revision** line.

CLI: Xmodem Download from a PC or Unix Workstation to Primary or Secondary Flash

Using Xmodem and a terminal emulator, you can download a switch software file to either primary or secondary flash.

Syntax: copy xmodem flash [< primary | secondary >]

Note that if you do not specify the flash destination, the Xmodem download defaults to primary flash.

For example, to download a switch software file named G0103.swi from a PC (running a terminal emulator program such as HyperTerminal) to primary flash:

1. Execute the following command in the CLI:

```
ProCurve# copy xmodem flash
The Primary OS Image will be deleted, continue [y/n]? y
Press 'Enter' and start XMODEM on your host...
```

Figure A-4. Example of the Command to Download Switch Software Using Xmodem

2. Execute the terminal emulator commands to begin the Xmodem transfer. For example, using HyperTerminal:
 - a. Click on **Transfer**, then **Send File**.
 - b. Type the file path and name in the Filename field.
 - c. In the Protocol field, select **Xmodem**.
 - d. Click on the **Send** button.

The download can take several minutes, depending on the baud rate used in the transfer.

3. When the download finishes, you must reboot the switch to implement the newly downloaded switch software. To do so, use one of the following commands:

boot system flash <primary | secondary>

Reboots the switch from the selected flash memory.

-o/-

reload

Reboots the switch from the flash image currently in use.

(For more on these commands, refer to “Rebooting the Switch” on page 6-17.)

4. To confirm that the operating system downloaded correctly, use the **show system**, **show version**, or **show flash** CLI commands.

Check the **Firmware revision** line. It should show the switch software version that you downloaded in the preceding steps.

If you need information on primary/secondary flash memory and the boot commands, refer to “Using Primary and Secondary Flash Image Options” on page 6-12.

Switch-to-Switch Download

You can use TFTP to transfer a switch software file between two ProCurve switches that use the same software code base. The menu interface enables you to transfer primary-to-primary or secondary-to-primary. The CLI enables all combinations of flash location options.

Menu: Switch-to-Switch Download to Primary Flash

Using the menu interface, you can download switch software from either the primary or secondary flash of one switch to the primary flash of another switch.

1. From the switch console Main Menu in the switch to receive the download, select **7. Download OS** screen.
2. Ensure that the **Method** parameter is set to **TFTP** (the default).
3. In the **TFTP Server** field, enter the IP address of the remote switch containing the switch software you want to download.
4. For the **Remote File Name**, enter one of the following:
 - To download the switch software from the primary flash of the source switch, type **flash** or **/os/primary** in lowercase characters.
 - To download the switch software from the secondary flash of the source switch, type **/os/secondary**.
5. Press **[Enter]**, then **[X]** (for **eXecute**) to begin the switch software download.
6. A “progress” bar indicates the progress of the download. When the entire operating system has been received, all activity on the switch halts and the following messages appear:

Validating and writing system software to FLASH...

7. After the primary flash memory has been updated with the new operating system, you must reboot the switch to implement the newly downloaded software. From the Main Menu, press **[6]** (for **Reboot Switch**). You will then see this prompt:

```
Continue reboot of system? : No
```

Press the space bar once to change No to Yes, then press **[Enter]** to begin the reboot.

8. To confirm that the operating system downloaded correctly:
 - a. From the Main Menu, select

Status and Counters

General System Information

- b. Check the **Firmware revision** line.

CLI: Switch-To-Switch Downloads

You can download a switch software file between two switches that use the same code base and which are connected on your LAN. To do so, use a **copy tftp** command from the destination switch. The options for this CLI feature include:

- Copy from primary flash in the source to either primary or secondary in the destination.
- Copy from either primary or secondary flash in the source to either primary or secondary flash in the destination.

Downloading from Primary Only. This command (executed in the destination switch) downloads the switch software from the source switch's primary flash to either the primary or secondary flash in the destination switch.

Syntax: copy tftp flash < ip-addr > flash [primary | secondary]

If you do not specify either a primary or secondary flash location for the destination, the download automatically goes to primary flash.

For example, to download switch software from primary flash in a switch with an IP address of 10.28.227.103 to the primary flash in the destination switch, you would execute the following command in the destination switch's CLI:

```
ProCurve# copy tftp flash 10.29.227.103 flash
Device will be rebooted, do you want to continue [y/n] Y
00107K
```

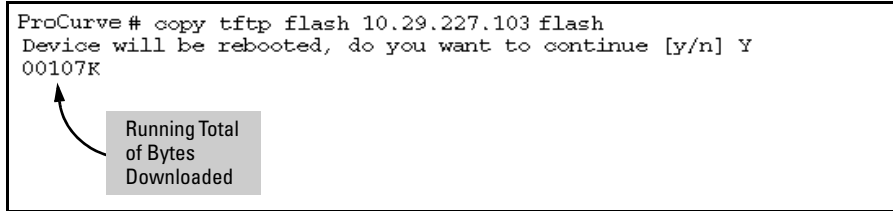

Figure A-5. Switch-To-Switch, from Primary in Source to Either Flash in Destination

Downloading from Either Flash in the Source Switch to Either Flash in the Destination Switch. This command (executed in the destination switch) gives you the most options for downloading between switches.

Syntax: copy tftp flash < ip-addr > < /os/primary > | < /os/secondary >
 [primary | secondary]

If you do not specify either a primary or secondary flash location for the destination, the download automatically goes to primary flash.

For example, to download switch software from secondary flash in a switch with an IP address of 10.28.227.103 to the secondary flash in the destination switch, you would execute the following command in the destination switch's CLI:

```
ProCurve# copy tftp flash 10.29.227.103 /os/secondary secondary
Device will be rebooted, do you want to continue [y/n] Y
01084K
```

Figure A-6. Switch-to-Switch, from Either Flash in Source to Either Flash in Destination

Using ProCurve Manager Plus to Update Switch Software

ProCurve Manager Plus include a software update utility for updating on ProCurve switch products. For further information, refer to the *Getting Started Guide* and the *Administrator's Guide*, provided electronically with the application.

Troubleshooting TFTP Downloads

When using the menu interface, if a TFTP download fails, the Download OS screen indicates the failure.

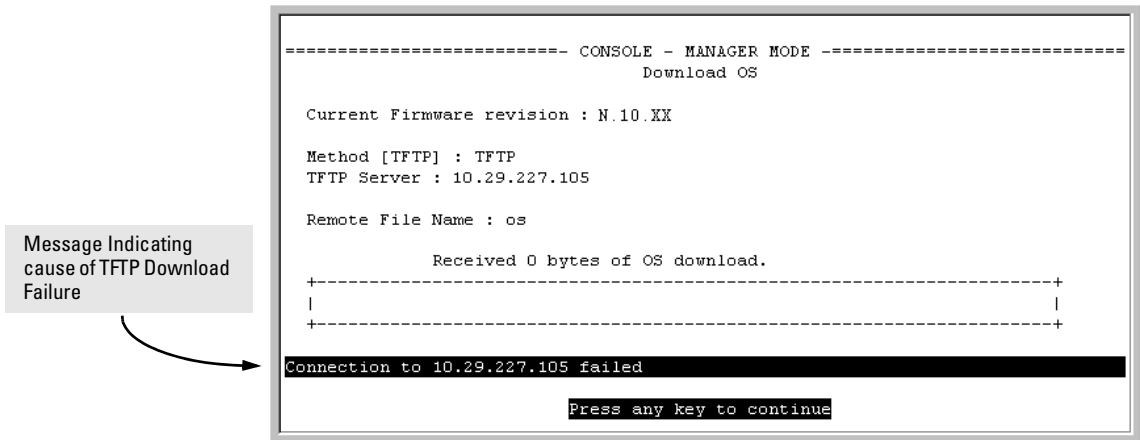

```
----- CONSOLE - MANAGER MODE -----  
Download OS  
  
Current Firmware revision : N.10.XX  
  
Method [TFTP] : TFTP  
TFTP Server : 10.29.227.105  
  
Remote File Name : os  
  
Received 0 bytes of OS download.  
+-----+  
|  
+-----+  
  
Connection to 10.29.227.105 failed  
  
Press any key to continue
```

Message Indicating cause of TFTP Download Failure

Figure A-7. Example of Message for Download Failure

To find more information on the cause of a download failure, examine the messages in the switch’s Event Log by executing this CLI command:

```
ProCurve# show log tftp
```

(For more on the Event Log, see “Using Logging To Identify Problem Sources” on page C-23.)

Some of the causes of download failures include:

- Incorrect or unreachable address specified for the **TFTP Server** parameter. This may include network problems.
- Incorrect VLAN.
- Incorrect name specified for the **Remote File Name** parameter, or the specified file cannot be found on the TFTP server. This can also occur if the TFTP server is a Unix machine and the case (upper or lower) for the filename on the server does not match the case for the filename entered for the **Remote File Name** parameter in the Download OS screen.
- One or more of the switch’s IP configuration parameters are incorrect.

File Transfers

Transferring Switch Configurations

- For a Unix TFTP server, the file permissions for the switch software file do not allow the file to be copied.
- Another console session (through either a direct connection to a terminal device or through Telnet) was already running when you started the session in which the download was attempted.

Note

If an error occurs in which normal switch operation cannot be restored, the switch automatically reboots itself. In this case, an appropriate message is displayed after the switch reboots.

Transferring Switch Configurations

Transfer Features

Feature	Default	Menu	CLI	Web
use TFTP to copy from a remote host to a config file	n/a	—	below	—
use TFTP to copy a config file to a remote host	n/a	—	page A-19	—
use Xmodem to copy a configuration from a serially connected host to a config file	n/a	—	page A-19	—
Use Xmodem to copy a config file to a serially connected host	n/a	—	page A-20	—

Using the CLI commands described in this section, you can copy switch configurations to and from a switch.

TFTP: Copying a Configuration from a Remote Host.

Syntax: `copy tftp < startup-config | running-config> < ip-address > < remote-file >`

This command copies a configuration from a remote host to the startup-config file in the switch. (Refer to Chapter 6, “Switch Memory and Configuration” for information on the startup-config file.)

For example, to download a configuration file named **sw2810** in the **configs** directory on drive “**d**” in a remote host having an IP address of 10.28.227.105:

```
ProCurve# copy tftp startup-config 10.28.227.105
d:\configs\sw2810
```

TFTP: Copying a Configuration File to a Remote Host.

Syntax: copy < startup-config | running-config > tftp < ip-addr > < remote-file >

This command copies the switch's startup configuration (startup-config file) to a remote TFTP host.

For example, to upload the current startup configuration to a file named **sw2810** in the configs directory on drive "d" in a remote host having an IP address of 10.28.227.105:

```
ProCurve# copy startup-config tftp 10.28.227.105
          d:\configs\sw2810
```

Xmodem: Copying a Configuration File from the Switch to a Serially Connected PC or Unix Workstation. To use this method, the switch must be connected via the serial port (this is an RJ45 port on the front panel of the 2810 switch) to a PC or Unix workstation to which you want to copy the configuration file. You will need to:

- Determine a filename to use.
- Know the directory path you will use to store the the configuration file.

Syntax: copy < startup-config | running-config > xmodem < pc | unix >

For example, to copy a configuration file to a PC serially connected to the switch:

1. Determine the file name and directory location on the PC.
2. Execute the following command:

```
ProCurve# copy startup-config xmodem pc
```

3. After you see the following prompt, press **[Enter]**.

```
Press 'Enter' and start XMODEM on your host...
```

4. Execute the terminal emulator commands to begin the file transfer.

Xmodem: Copying a Configuration File from a Serially Connected PC or Unix Workstation. To use this method, the switch must be connected via the serial port to a PC or Unix workstation on which is stored the configuration file you want to copy. To complete the copying, you will need to know the name of the file to copy and the drive and directory location of the file.

Syntax: copy xmodem startup-config < pc | unix >

For example, to copy a configuration file from a PC serially connected to the switch:

1. Execute the following command:

```
ProCurve# copy xmodem startup-config pc
Device will be rebooted, do you want to continue [y/n]? y
Press 'Enter' and start XMODEM on your host...
```

2. After you see the above prompt, press **[Enter]**.
3. Execute the terminal emulator commands to begin the file transfer.
4. When the download finishes, you must reboot the switch to implement the newly downloaded OS. To do so, use one of the following commands:

```
boot system flash < primary | secondary >
                                          Reboots from the selected flash.
```

-or-

```
reload
                                          Reboots from the flash image currently in use.
```

(For more on these commands, refer to “Rebooting the Switch” on page 6-17.)

Copying Diagnostic Data to a Remote Host, PC, or Unix Workstation

You can use the CLI to copy the following types of switch data to a text file in a management device:

- **Command Output:** Sends the output of a switch CLI command as a file on the destination device.
- **Event Log:** Copies the switch's Event Log into a file on the destination device.
- **Crash Data:** OS-specific data useful for determining the reason for a system crash.
- **Crash Log:** Processor-Specific operating data useful for determining the reason for a system crash.

Copying Command Output to a Destination Device

This command directs the displayed output of a CLI command to a file in a destination device.

Syntax: `copy command-output <"cli-command"> tftp <ip-address>`
 `<filepath-filename>`

`copy command-output <"cli-command"> xmodem`

For example, to use Xmodem to copy the output of **show config** to a serially connected PC:

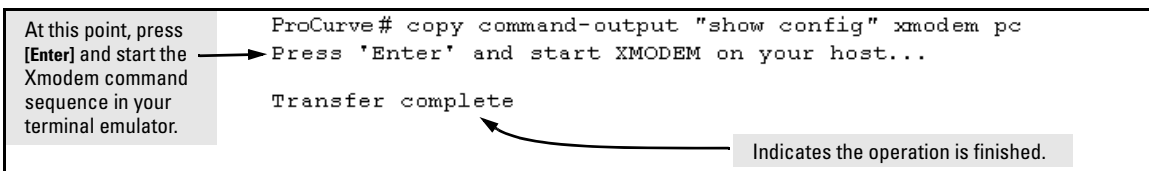

Figure A-8. Example of Sending Command Output to a File on an Attached PC

Note that the command you specify must be enclosed in double-quote marks.

Copying Event Log Output to a Destination Device

This command uses TFTP or Xmodem to copy the Event Log content to a PC or UNIX workstation on the network.

Syntax: `copy event-log tftp < ip-address > < filepath and filename >`
 `copy event-log xmodem`

For example, to copy the event log to a PC connected to the switch:

At this point, press [Enter] and start the Xmodem command sequence in your terminal emulator.	<pre>ProCurve: copy event-log xmodem pc Press 'Enter' and start XMODEM on your host... Transfer complete</pre>
---	---

Figure A-9. Example of Sending Event Log Content to a File on an Attached PC

Copying Crash Data Content to a Destination Device

This command uses TFTP or Xmodem to copy the Crash Data content to a PC or UNIX workstation on the network. You can copy individual slot information or the master switch information. If you do not specify either, the command defaults to the master data.

Syntax: `copy crash-data [< slot-id | master >] xmodem`
 `copy crash-data [< slot-id | master >] tftp < ip-address > < filename >`

where: `slot-id = a - h`, and *retrieves the crash log or crash data from the processor on the module in the specified slot.*

`master` *Retrieves crash log or crash data from the switch's chassis processor.*

For example, to copy the switch's crash data to a file in a PC:

At this point, press [Enter] and start the Xmodem command sequence in your terminal emulator.	<pre>ProCurve(config)# copy crash-data xmodem pc Press 'Enter' and start XMODEM on your host... Transfer complete</pre>
---	--

Figure A-10. Example of Copying Switch Crash Data Content to a PC

File Transfers

Copying Diagnostic Data to a Remote Host, PC, or Unix Workstation

Monitoring and Analyzing Switch Operation

Contents

Overview	B-3
Status and Counters Data	B-4
Menu Access To Status and Counters	B-5
General System Information	B-6
Menu Access	B-6
CLI Access	B-6
Switch Management Address Information	B-7
Menu Access	B-7
CLI Access	B-7
Module Information	B-8
Menu: Displaying Port Status	B-8
CLI Access	B-8
Port Status	B-9
Menu: Displaying Port Status	B-9
CLI Access	B-9
Web Access	B-9
Viewing Port and Trunk Group Statistics and Flow Control Status	B-10
Menu Access to Port and Trunk Statistics	B-11
CLI Access To Port and Trunk Group Statistics	B-12
Web Browser Access To View Port and Trunk Group Statistics	B-12
Viewing the Switch's MAC Address Tables	B-13
Menu Access to the MAC Address Views and Searches	B-13
CLI Access for MAC Address Views and Searches	B-16
Spanning Tree Protocol (STP) Information	B-17
Menu Access to STP Data	B-17
CLI Access to STP Data	B-18
Internet Group Management Protocol (IGMP) Status	B-19
VLAN Information	B-20
Web Browser Interface Status Information	B-22

Monitoring and Analyzing Switch Operation
Contents

Port and Static Trunk Monitoring Features	B-23
Menu: Configuring Port and Static Trunk Monitoring	B-24
CLI: Configuring Port and Static Trunk Monitoring	B-26
Web: Configuring Port Monitoring	B-28
Locating a Device	B-28

Overview

The switch has several built-in tools for monitoring, analyzing, and troubleshooting switch and network operation:

- **Status:** Includes options for displaying general switch information, management address data, port status, port and trunk group statistics, MAC addresses detected on each port or VLAN, and STP, IGMP, and VLAN data (*page B-4*).
- **Counters:** Display details of traffic volume on individual ports (*page B-10*).
- **Event Log:** Lists switch operating events (*“Using Logging To Identify Problem Sources” on page C-23*).
- **Alert Log:** Lists network occurrences detected by the switch—in the Status | Overview screen of the web browser interface (*page 5-6*).
- **Configurable trap receivers:** Uses SNMP to enable management stations on your network to receive SNMP traps from the switch (*“SNMP Notification and Traps” on page 12-18*).
- **Port monitoring (mirroring):** Copy all traffic from the specified ports to a designated monitoring port (*page B-23*).
- **Chassis Locator LED:** The blue Locator LED lights up when you enter the **chassislocate** command (

Note

Link test and ping test—analysis tools in troubleshooting situations—are described in chapter 18, “Troubleshooting”. See page C-35.

Status and Counters Data

This section describes the status and counters screens available through the switch console interface and/or the web browser interface.

Note

You can access all console screens from the web browser interface via Telnet to the console. Telnet access to the switch is available in the Device View window under the **Configuration** tab.

Status or Counters Type	Interface	Purpose	Page
Menu Access to Status and Counters	Menu	Access menu interface for status and counter data.	B-5
General System Information	Menu, CLI	Lists switch-level operating information.	B-6
Management Address Information	Menu, CLI	Lists the MAC address, IP address, and IPX network number for each VLAN or, if no VLANs are configured, for the switch.	B-7
Module Information	Menu, CLI	Lists the module type and description for each slot in which a module is installed.	B-8
Port Status	Menu, CLI, Web	Displays the operational status of each port.	B-9
Port and Trunk Statistics and Flow Control Status	Menu, CLI, Web	Summarizes port activity and lists per-port flow control status.	B-10
VLAN Address Table	Menu, CLI	Lists the MAC addresses of nodes the switch has detected on specific VLANs, with the corresponding switch port.	B-13
Port Address Table	Menu, CLI	Lists the MAC addresses that the switch has learned from the selected port.	B-13
STP Information	Menu, CLI	Lists Spanning Tree Protocol data for the switch and for individual ports. If VLANs are configured, reports on a per-VLAN basis.	B-17
IGMP Status	Menu, CLI	Lists IGMP groups, reports, queries, and port on which querier is located.	B-19
VLAN Information	Menu, CLI	For each VLAN configured in the switch, lists 802.1Q VLAN ID and up/down status.	B-20
Port Status Overview and Port Counters	Web	Shows port utilization and counters, and the Alert Log.	B-22

Menu Access To Status and Counters

Beginning at the Main Menu, display the Status and Counters menu by selecting:

1. Status and Counters

```
===== CONSOLE - MANAGER MODE =====  
Status and Counters Menu  
  
1. General System Information  
2. Switch Management Address Information  
3. Module Information  
4. Port Status  
5. Port Counters  
6. Vlan Address Table  
7. Port Address Table  
8. Spanning Tree Information  
0. Return to Main Menu...  
  
Displays switch management information including software versions.  
To select menu item, press item number, or highlight item and press <Enter>.
```

Figure B-1. The Status and Counters Menu

Each of the above menu items accesses the read-only screens described on the following pages. Refer to the online help for a description of the entries displayed in these screens.

General System Information

Menu Access

From the console Main Menu, select:

1. Status and Counters

1. General System Information

```
===== CONSOLE - MANAGER MODE =====
                        Status and Counters - General System Information

System Contact      :
System Location     :

Firmware revision  : G.05.01           Base MAC Addr   : 0001e7-a09900
ROM Version        : G.05.00           Serial Number    : S2600017409

Up Time            : 2 hours           Memory  - Total  : 24,588,136
CPU Util (%)       : 1                 Free      : 19,613,568

IP Mgmt  - Pkts Rx : 0                 Packet  - Total  : 832
          Pkts Tx  : 0                 Buffers  Free   : 793
                                          Lowest   : 769
                                          Missed   : 0

Actions->  Back  Help

Return to previous screen.
Use arrow keys to change action selection and <Enter> to execute action.
```

Figure B-2. Example of General Switch Information

This screen dynamically indicates how individual switch resources are being used. See the online Help for details.

CLI Access

Syntax: show system-information

Switch Management Address Information

Menu Access

From the Main Menu, select:

1. Status and Counters . . .
2. Switch Management Address Information

```
===== CONSOLE - MANAGER MODE =====
                        Status and Counters - Management Address Information

Time Server Address : Disabled

  VLAN Name      MAC Address      IP Address
-----
DEFAULT VLAN    0001e7-a09900    10.28.227.101
VLAN-22         0001e7-a09901    Disabled
VLAN-33         0001e7-a09902    Disabled

Actions->      Back      Help
Return to previous screen.
Use arrow keys to change action selection and <Enter> to execute action.
```

Figure B-3. Example of Management Address Information with VLANs Configured

This screen displays addresses that are important for management of the switch. If multiple VLANs are *not* configured, this screen displays a single IP address for the entire switch. See the online Help for details.

CLI Access

Syntax: show management

Module Information

Use this feature to determine which slots have modules installed and which type(s) of modules are installed.

Menu: Displaying Port Status

From the Main Menu, select:

1. Status and Counters . . .
3. Module Information

```
=====-- CONSOLE - MANAGER MODE -----  
Status and Counters - Module Information  
  
Slot      Module Type      Module Description  
-----  
A          HP J4863A 10/100/1000Base-TX module  
B          HP J4863A 10/100/1000Base-TX module  
C          HP J4863A 10/100/1000Base-TX module  
D          HP J4863A 10/100/1000Base-TX module  
E          HP J4864A Transceiver module  
F          Slot Available  
G          Slot Available  
H          Slot Available  
  
Actions->  Back      Help  
  
Return to previous screen.  
Use up/down arrow keys to scroll to other entries, left/right arrow keys to  
change action selection, and <Enter> to execute action.
```

Figure B-4. Example of Module Information in the Menu Interface

CLI Access

Syntax: show module

Port Status

The web browser interface and the console interface show the same port status data.

Menu: Displaying Port Status

From the Main Menu, select:

1. **Status and Counters . . .**
4. **Port Status**

```

HPswitch
----- CONSOLE - MANAGER MODE -----
                Status and Counters - Port Status

Port      Type      Intrusion
Alert     Enabled  Status   Mode     Flow
-----
A1      10/100TX  No       Yes      Down    10FDx   off
A2      10/100TX  No       Yes      Down    10FDx   off
A3      10/100TX  No       Yes      Down    10FDx   off
A4      10/100TX  No       Yes      Down    10FDx   off
A5      10/100TX  No       Yes      Down    10FDx   off
A6      10/100TX  No       Yes      Down    10FDx   off
A7      10/100TX  No       Yes      Down    10FDx   off
A8      10/100TX  No       Yes      Down    10FDx   off
A9      10/100TX  No       Yes      Down    10FDx   off
A10     10/100TX  No       Yes      Down    10FDx   off
A11     10/100TX  No       Yes      Down    10FDx   off

Actions->  Back      Intrusion log  Help

Return to previous screen.
Use up/down arrow keys to scroll to other entries, left/right arrow keys to
change action selection, and <Enter> to execute action.
  
```

Figure B-5. Example of Port Status on the Menu Interface

CLI Access

Syntax: show interfaces brief

Web Access

1. Click on the **Status** tab.
2. Click on **Port Status**.

Viewing Port and Trunk Group Statistics and Flow Control Status

Feature	Default	Menu	CLI	Web
viewing port and trunk statistics for all ports, and flow control status	n/a	page B-11	page B-12	page B-12
viewing a detailed summary for a particular port or trunk	n/a	page B-11	page B-12	page B-12
resetting counters	n/a	page B-11	page B-12	page B-12

These features enable you to determine the traffic patterns for each port since the last reboot or reset of the switch. You can display:

- A general report of traffic on all LAN ports and trunk groups in the switch, along with the per-port flow control status (On or Off).
- A detailed summary of traffic on a selected port or trunk group.

You can also reset the counters for a specific port.

The menu interface and the web browser interface provide a dynamic display of counters summarizing the traffic on each port. The CLI lets you see a static “snapshot” of port or trunk group statistics at a particular moment.

As mentioned above, rebooting or resetting the switch resets the counters to zero. You can also reset the counters to zero for the current session. This is useful for troubleshooting. See the “Note On Reset”, below.

Note on Reset

The **Reset** action resets the counter display to zero for the current session, but does not affect the cumulative values in the actual hardware counters. (In compliance with the SNMP standard, the values in the hardware counters are not reset to zero unless you reboot the switch.) Thus, using the **Reset** action resets the displayed counters to zero for the current session only. Exiting from the console session and starting a new session restores the counter displays to the accumulated values in the hardware counters.

Menu Access to Port and Trunk Statistics

To access this screen from the Main Menu, select:

1. Status and Counters . . .
4. Port Counters

```

=====  CONSOLE - MANAGER MODE  =====
                        Status and Counters - Port Counters

Port      Total Bytes  Total Frames  Errors Rx  Drops Tx  Flow
-----  -
A1      195,072      323          0          0      off
A2      651,816      871          0          0      off
A3      290,163      500          0          0      off
A4      260,134      501          0          0      off
A5-Trkl  859,363      5147         0          0      off
A6-Trkl  674,574      1693         0          0      off
C1       26,554       246          0          0      off
C2      113,184       276          0          0      off
C3         0         0            0          0      off

Actions->  Back      Show details  Reset      Help

Return to previous screen.
Use up/down arrow keys to scroll to other entries, left/right arrow keys to
change action selection, and <Enter> to execute action.

```

Figure B-6. Example of Port Counters on the Menu Interface

To view details about the traffic on a particular port, use the  key to highlight that port number, then select **Show Details**. For example, selecting port A2 displays a screen similar to figure B-7, below.

```

=====  CONSOLE - MANAGER MODE  =====
                        Status and Counters - Port Counters - Port A2

Link Status      : up

Bytes Rx         : 630,746          Bytes Tx         : 21,070
Unicast Rx      : 568              Unicast Tx       : 285
Bcast/Mcast Rx  : 18              Bcast/Mcast Tx   : 0

PCS Rx          : 0                Drops Tx         : 0
Alignment Rx    : 0                Collisions Tx    : 0
Runts Rx        : 0                Late Colln Tx   : 0
Giants Rx       : 0                Excessive Colln : 0
Total Rx Errors : 0                Deferred Tx      : 0

Actions->  Back      Reset      Help

Return to previous screen.
Use arrow keys to change action selection and <Enter> to execute action.

```

Figure B-7. Example of the Display for Show details on a Selected Port

This screen also includes the **Reset** action for the current session. (See the “Note on Reset” on page B-10.)

CLI Access To Port and Trunk Group Statistics

To Display the Port Counter Summary Report. This command provides an overview of port activity for all ports on the switch.

Syntax: show interfaces

To Display a Detailed Traffic Summary for Specific Ports. This command provides traffic details for the port(s) you specify.

Syntax: show interfaces [ethernet] <port-list >

To Reset the Port Counters for a Specific Port. This command resets the counters for the specified ports to zero for the current session. (See the “Note on Reset” on page B-10.)

Syntax: clear statistics < [ethernet] port-list >

Web Browser Access To View Port and Trunk Group Statistics

1. Click on the **Status** tab.
2. Click on **Port Counters**.
3. To refresh the counters for a specific port, click anywhere in the row for that port, then click on **Refresh**.

Note

To reset the port counters to zero, you must reboot the switch.

Viewing the Switch's MAC Address Tables

Feature	Default	Menu	CLI	Web
viewing MAC addresses on all ports on a specific VLAN	n/a	page B-13	page B-16	—
viewing MAC addresses on a specific port	n/a	page B-15	page B-16	—
searching for a MAC address	n/a	page B-15	page B-16	—

These features help you to view:

- The MAC addresses that the switch has learned from network devices attached to the switch
- The port on which each MAC address was learned

Menu Access to the MAC Address Views and Searches

Per-VLAN MAC-Address Viewing and Searching. This feature lets you determine which switch port on a selected VLAN is being used to communicate with a specific device on the network. The per-VLAN listing includes:

- The MAC addresses that the switch has learned from network devices attached to the switch
- The port on which each MAC address was learned

1. From the Main Menu, select:

1. Status and Counters
5. VLAN Address Table

2. The switch then prompts you to select a VLAN.

```
Select VLAN : DEFAULT_VLAN
```

3. Use the Space bar to select the VLAN you want, then press **[Enter]**. The switch then displays the MAC address table for that VLAN:

```
----- CONSOLE - MANAGER MODE -----  
Status and Counters - Address Table  
  
MAC Address  Located on Port  
-----  
0030c1-7f49c0 A3  
0030c1-7fec40 A1  
0030c1-b29ac0 A3  
0060b0-17de5b A3  
0060b0-880a80 A2  
0060b0-df1a00 A3  
0060b0-df2a00 A3  
0060b0-e9a200 A3  
009027-e74f90 A3  
080009-21ae84 A3  
080009-62c411 A3  
080009-6563e2 A3  
  
Actions->  Back  Search  Next page  Prev page  Help  
  
Return to previous screen.  
Use up/down arrow keys to scroll to other entries, left/right arrow keys to  
change action selection, and <Enter> to execute action.
```

Figure B-8. Example of the Address Table

To page through the listing, use **N**ext page and **P**rev page.

Finding the Port Connection for a Specific Device on a VLAN. This feature uses a device's MAC address that you enter to identify the port used by that device.

1. Proceeding from figure B-8, press **[S]** (for **S**earch), to display the following prompt:

Enter MAC address: _

2. Type the MAC address you want to locate and press **[Enter]**. The address and port number are highlighted if found. If the switch does not find the MAC address on the currently selected VLAN, it leaves the MAC address listing empty.

Located MAC Address and Corresponding Port Number

```
----- CONSOLE - MANAGER MODE -----  
Status and Counters - Address Table  
  
MAC Address  Located on Port  
-----  
0030c1-7fcc6d 2  
005004-17df9c 1  
0060b0-889e00 1
```

Figure B-9. Example of Menu Indicating Located MAC Address

3. Press **[P]** (for **P**rev page) to return to the full address table listing.

Port-Level MAC Address Viewing and Searching. This feature displays and searches for MAC addresses on the specified port instead of for all ports on the switch.

1. From the Main Menu, select:

1. Status and Counters
7. Port Address Table

```
===== CONSOLE - MANAGER MODE =====
                        Status and Counters Menu

1. General System Information
2. Switch Management Address Information
3. Module Information
4. Port Status
5. Port Counters
6. Vlan Address Table
7. Port Address Table
8. Spanning Tree Information
0. Return to Main Menu...

Select port : A1
Type port number or press <Space> to scroll ports. Press <Enter> to select.
To select menu item, press item number, or highlight item and press <Enter>.
```

Prompt for Selecting
the Port To Search

Figure B-10. Listing MAC Addresses for a Specific Port

2. Use the Space bar to select the port you want to list or search for MAC addresses, then press **[Enter]** to list the MAC addresses detected on that port.

Determining Whether a Specific Device Is Connected to the Selected Port. Proceeding from step 2, above:

1. Press **[S]** (for **Search**), to display the following prompt:
Enter MAC address: _
2. Type the MAC address you want to locate and press **[Enter]**. The address is highlighted if found. If the switch does not find the address, it leaves the MAC address listing empty.
3. Press **[P]** (for **Prev page**) to return to the previous per-port listing.

CLI Access for MAC Address Views and Searches

Syntax: show mac-address
 [vlan < vlan-id >]
 [ethernet]< port-list >
 [< mac-addr >]

To List All Learned MAC Addresses on the Switch, with The Port Number on Which Each MAC Address Was Learned.

```
ProCurve> show mac-address
```

To List All Learned MAC Addresses on one or more ports, with Their Corresponding Port Numbers. For example, to list the learned MAC address on ports A1 through A4 and port A6:

```
ProCurve> show mac-address a1-a4,a6
```

To List All Learned MAC Addresses on a VLAN, with Their Port Numbers. This command lists the MAC addresses associated with the ports for a given VLAN. For example:

```
ProCurve> show mac-address vlan 100
```

Note

The switch operates with a multiple forwarding database architecture. For more on this topic, refer to “Duplicate MAC Addresses Across VLANs” on page C-21.

To Find the Port On Which the Switch Learned a Specific MAC Address. For example, to find the port on which the switch learns a MAC address of 080009-21ae84:

```
ProCurve# show mac-address 080009-21ae84
Status and Counters - Address Table - 080009-21ae84
  MAC Address : 080009-21ae84
  Located on Port : A2
```

Figure B-11. List the Port on which the Switch Deleted a MAC Address

Spanning Tree Protocol (STP) Information

Menu Access to STP Data

From the Main Menu, select:

1. Status and Counters . . .
8. Spanning Tree Information

STP must be enabled on the switch to display the following data:

```
----- CONSOLE - MANAGER MODE -----  
                Status and Counters - Spanning Tree Information  
  
STP Enabled           : Yes  
Switch Priority       : 32,768  
Hello Time           : 2  
Max Age              : 20  
Forward Delay        : 15  
  
Topology Change Count : 3  
Time Since Last Change : 4 mins  
  
Root MAC Address      : 0030c1-7fcc40  
Root Path Cost        : 0  
Root Port             : This switch is root  
Root Priority          : 32768  
  
Actions->  Back  Show ports  Help  
  
Return to previous screen.  
Use arrow keys to change action selection and <Enter> to execute action.
```

Figure B-12. Example of Spanning Tree Information

Use this screen to determine current switch-level STP parameter settings and statistics.

You can use the **Show ports** action at the bottom of the screen to display port-level information and parameter settings for each port in the switch (including port type, cost, priority, operating state, and designated bridge) as shown in figure B-13.

```
----- CONSOLE - MANAGER MODE -----  
Status and Counters - Spanning Tree - Port Information  
  
Port      Type      Cost  Priority  State      Designated Bridge  
-----  
A1 100/1000T 5      128      Forwarding 0001e7-a09900  
A2 100/1000T 5      128      Forwarding 0001e7-a09900  
A3 100/1000T 5      128      Disabled  
A4 100/1000T 5      128      Disabled  
A5 100/1000T 5      128      Disabled  
A6 100/1000T 5      128      Disabled  
C1 1000SX     5      128      Forwarding 0001e7-a09900  
C2 1000SX     5      128      Forwarding 0001e7-a09900  
C3 1000SX     5      128      Forwarding 0001e7-a09900  
  
Actions->  Back      Help  
  
Return to previous screen.  
Use up/down arrow keys to scroll to other entries, left/right arrow keys to  
change action selection, and <Enter> to execute action.
```

Figure B-13. Example of STP Port Information

CLI Access to STP Data

This option lists the STP configuration, root data, and per-port data (cost, priority, state, and designated bridge).

Syntax: show spanning-tree

ProCurve> show spanning-tree

Internet Group Management Protocol (IGMP) Status

The switch uses the CLI to display the following IGMP status on a per-VLAN basis:

Show Command	Output
show ip igmp	Global command listing IGMP status for all VLANs configured in the switch: <ul style="list-style-type: none"> • VLAN ID (VID) and name • Active group addresses per VLAN • Number of report and query packets per group • Querier access port per VLAN
show ip igmp <vlan-id>	Per-VLAN command listing above IGMP status for specified VLAN (VID)
show ip igmp group <ip-addr>	Lists the ports currently participating in the specified group, with port type, Access type, Age Timer data and Leave Timer data.

For example, suppose that **show ip igmp** listed an IGMP group address of 224.0.1.22. You could get additional data on that group by executing the following:

```

ProCurve>show ip igmp group 224.0.1.22

IGMP ports for group 224.0.1.22

Port Type      Access      Age Timer  Leave Timer
-----
A3   10/100TX  host        0           0

```

Figure B-14. Example of IGMP Group Data

VLAN Information

The switch uses the CLI to display the following VLAN status:

Syntax: show vlan

Lists:

- *Maximum number of VLANs to support*
- *Existing VLANs*
- *Status (static or dynamic)*
- *Primary VLAN*

Syntax: show vlan < vlan-id >

For the specified VLAN, lists:

- *Name, VID, and status (static/dynamic)*
- *Per-Port mode (tagged, untagged, forbid, no/auto)*
- *“Unknown VLAN” setting (Learn, Block, Disable)*
- *Port status (up/down)*

For example, suppose that your switch has the following VLANs:

Ports	VLAN	VID
1 - 12	DEFAULT_VLAN	1
1, 2	VLAN-33	33
3, 4	VLAN-44	44

The next three figures show how you could list data on the above VLANs.

Listing the VLAN ID (VID) and Status for ALL VLANs in the Switch.

```
ProCurve > show vlan
Status and Counters - VLAN Information
VLAN support : Yes
Maximum VLANs to support : 9
Primary VLAN: DEFAULT_VLAN

802.1Q VLAN ID Name          Status
-----
1          DEFAULT_VLAN  Static
33         VLAN-33      Static
44         VLAN-44      Static
```

Figure B-15. Example of VLAN Listing for the Entire Switch

Listing the VLAN ID (VID) and Status for Specific Ports.

Because ports A1 and A2 are not members of VLAN-44, it does not appear in this listing.

```
ProCurve > show vlan ports A1-A2
Status and Counters - VLAN Information - for ports A1,A2
802.1Q VLAN ID Name          Status
-----
1          DEFAULT_VLAN  Static
33         VLAN-33      Static
```

Figure B-16. Example of VLAN Listing for Specific Ports

Listing Individual VLAN Status.

```
ProCurve > show vlan 1
Status and Counters - VLAN Information - Ports - VLAN 1
802.1Q VLAN ID : 1
Name           : DEFAULT_VLAN
Status        : Static

Port Information Mode      Unknown VLAN Status
-----
A1             Untagged Learn      Up
A2             Tagged   Learn      Up
A3             Untagged Learn      Up
A4             Untagged Learn      Down
A5             Untagged Learn      Down
.              .              .              .
.              .              .              .
.              .              .              .
```

Figure B-17. Example of Port Listing for an Individual VLAN

Web Browser Interface Status Information

The “home” screen for the web browser interface is the Status Overview screen, as shown below. As the title implies, it provides an overview of the status of the switch, including summary graphs indicating the network utilization on each of the switch ports, symbolic port status indicators, and the Alert Log, which informs you of any problems that may have occurred on the switch.

For more information on this screen, see chapter 5, ‘Using the Web Browser Interface’.

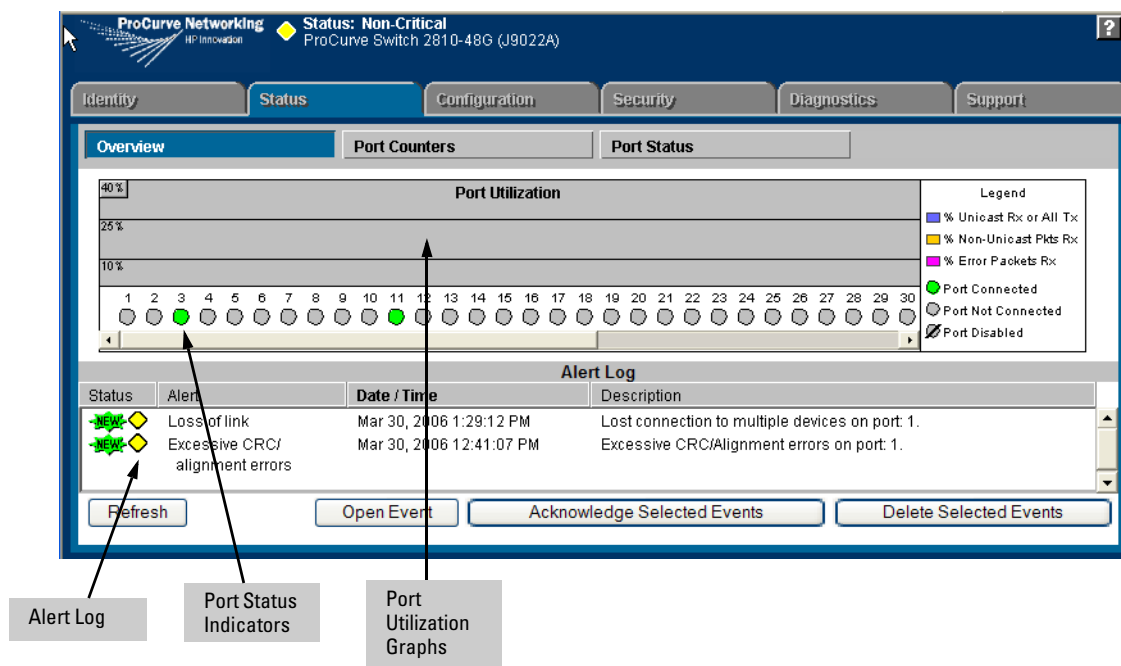

Figure B-18. Example of a Web Browser Interface Status Overview Screen

Port and Static Trunk Monitoring Features

Port Monitoring Features

Feature	Default	Menu	CLI	Web
display monitoring configuration	disabled	page B-24	page B-26	page B-28
configure the monitor port(s)	ports: none	page B-24	page B-26	page B-28
selecting or removing ports	none selected	page B-24	page B-27	page B-28

You can designate a port for monitoring inbound (ingress) and outbound (egress) traffic of other ports and of static trunks on the switch. The switch monitors the network activity by copying all inbound and outbound traffic on the specified interfaces to the designated monitoring port, to which a network analyzer can be attached.

The instructions below apply to all of the switches covered in this manual.

Note

Port trunks cannot be used as a monitoring port.

It is possible, when monitoring multiple interfaces in networks with high traffic levels, to copy more traffic to a monitor port than the link can support. In this case, some packets may not be copied to the monitor port.

Menu: Configuring Port and Static Trunk Monitoring

This procedure describes configuring the switch for monitoring when monitoring is disabled. (If monitoring has already been enabled, the screens will appear differently than shown in this procedure.)

1. From the Console Main Menu, select:

2. Switch Configuration...

3. Network Monitoring Port

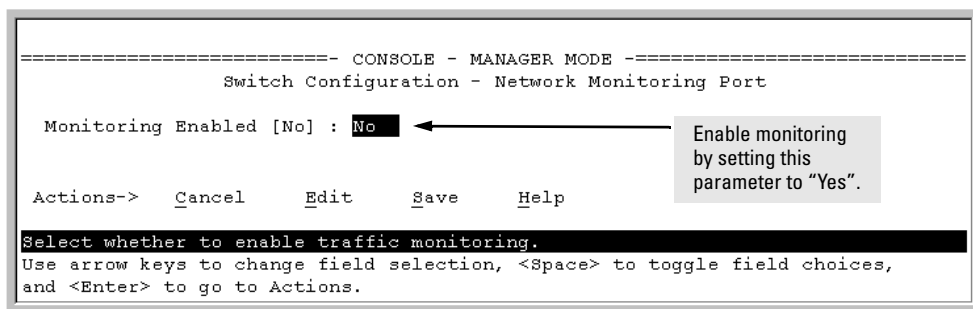

Figure B-19. The Default Network Monitoring Configuration Screen

2. In the Actions menu, press [E] (for **Edit**).
3. If monitoring is currently disabled (the default) then enable it by pressing the Space bar (or [Y]) to select **Yes**.
4. Press the down arrow key to display a screen similar to the following and move the cursor to the **Monitoring Port** parameter.

```

===== CONSOLE - MANAGER MODE =====
Switch Configuration - Network Monitoring Port

Monitoring Enabled [No] : Yes
Monitoring Port : A1
Monitor : Ports

Port      Type      Action      |      Port      Type      Action
-----+-----+-----+-----+-----+-----
A1      10/100TX      |      A10     10/100TX      |
A2      10/100TX      |      A11     10/100TX      |
A3      10/100TX      |      A12     10/100TX      |
A4      10/100TX      |      A13     10/100TX      |
A5      10/100TX      |      A14     10/100TX      |
A6      10/100TX      |      A15     10/100TX      |
A7      10/100TX      |      A20     10/100TX      |
A8      10/100TX      |      Trk1    Trunk          |

Actions->  C a n c e l      E d i t      S a v e      H e l p

Select the port that will act as the Monitoring Port.
Use arrow keys to change field selection, <Space> to toggle field choices,
and <Enter> to go to Actions.

```

Figure B-20. How To Select a Monitoring Port

5. Use the Space bar to select the port to use for monitoring.
6. Use the down arrow key to move the cursor to the **Action** column for the individual ports and position the cursor at a port you want to monitor.
7. Press the Space bar to select **Monitor** for each port and trunk that you want monitored. (Use the down arrow key to move from one interface to the next in the **Action** column.)
8. When you finish selecting ports to monitor, press **[Enter]**, then press **[S]** (for **Save**) to save your changes and exit from the screen.
9. Return to the Main Menu.

CLI: Configuring Port and Static Trunk Monitoring

Port and Static Trunk Monitoring Commands Used in This Section

show monitor	below
mirror-port	page B-26
monitor	page B-27

You must use the following configuration sequence to configure port and static trunk monitoring in the CLI:

1. Assign a monitoring (mirror) port.
2. Designate the port(s) and static trunk(s) to monitor.

Displaying the Monitoring Configuration. This command lists the port assigned to receive monitored traffic and the ports and/or trunks being monitored.

Syntax: show monitor

For example, if you assign port A6 as the monitoring port and configure the switch to monitor ports A1 - A3, **show monitor** displays the following:

```
ProCurve(config)# show monitor

Network Monitoring Port

Mirror Port: A6 ← Port receiving monitored traffic.

Monitoring sources
-----
A1 ← Monitored Ports
A2
A3
```

Figure B-21. Example of Monitored Port Listing

Configuring the Monitor Port. This command assigns or removes a monitoring port, and must be executed from the global configuration level. Removing the monitor port disables port monitoring and resets the monitoring parameters to their factory-default settings.

Syntax: [no] mirror-port [*port-num* >]

For example, to assign port A6 as the monitoring port:

```
ProCurve(config)# mirror-port a6
```

To turn off monitoring:

```
ProCurve(config)# no mirror-port
```

Selecting or Removing Ports and Static Trunks As Monitoring

Sources. After you configure a monitor port you can use either the global configuration level or the interface context level to select ports and static trunks as monitoring sources. You can also use either level to remove monitoring sources.

Syntax: [no] interface ethernet < monitor-list > monitor

where: < monitor-list > includes port numbers and static trunk names such as a4, c7, b5-b8, and trk1.

Elements in the monitor list can include port numbers and static trunk names at the same time.

For example, with a port such as port A6 configured as the monitoring (mirror) port, you would use either of the following commands to select these ports and static trunks for monitoring:

- A1 through A3, and A5
- Trunks 1 and 2

```
ProCurve(config)# int e a1-a3,a5,trk1,trk2 monitor
ProCurve(config)# int e a1-a3,a5,trk1,trk2
ProCurve(eth-A1-A3,A5,Trk1-Trk2)# monitor
```

From the global config level, selects ports and trunks for monitoring sources.

Selects the interface context level, then selects the ports as monitoring sources.

Figure B-22. Examples of Selecting Ports and Static Trunks as Monitoring Sources

```
ProCurve(eth-A1-A3,A5)# no int e a5 monitor
ProCurve(eth-A1-A3,A5)# no monitor
ProCurve(config)# no int e a5 monitor
ProCurve(config)# no int e a1-a3,a5 monitor
```

These two commands show how to disable monitoring at the interface context level for a single port or all ports in an interface context level.

These two commands show how to disable monitoring at the global config level for a single port or a group of ports.

Figure B-23. Examples of Removing Ports as Monitoring Sources

Web: Configuring Port Monitoring

To enable port monitoring:

1. Click on the **Configuration** tab.
2. Click on **Monitor Port**.
3. To monitor one or more ports.
 - a. Click on the radio button for **Monitor Selected Ports**.
 - b. Select the port(s) to monitor.
4. Click on **Apply Changes**.

To remove port monitoring:

1. Click on the **Monitoring Off** radio button.
2. Click on **Apply Changes**.

For web-based Help on how to use the web browser interface screen, click on the [?] button provided on the web browser screen.

Locating a Device

If you are trying to locate a particular switch you can enter the **chassislocate** command. The blue Locator LED will light up on that switch.

Syntax: chassislocate [blink | on | off]

Locate a device by using the blue Locate LED on the front panel.

blink <1-1440>

Blinks the chassis Locate LED for a selected number of minutes (default is 30 minutes).

on <1-1440>

Turns the chassis Locate LED on for a selected number of minutes (default is 30 minutes).

off

Turns the chassis Locate LED off.

```
ProCurve(config)# chassislocate
blink <1-1440>      Blink the chassis locate led (default 30 minutes).
off                Turn the chassis locate led off.
on <1-1440>        Turn the chassis locate led on (default 30 minutes).
ProCurve(config)# chassislocate
```

Figure B-24. The chassislocate command

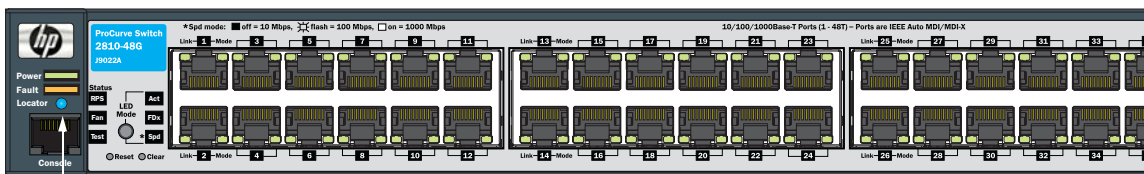

Locator LED

Figure B-25. Location of the Locator LED

Monitoring and Analyzing Switch Operation
Locating a Device

Troubleshooting

Contents

Overview	C-3
Troubleshooting Approaches	C-3
Chassis Over-Temperature Detection	C-5
Browser or Telnet Access Problems	C-7
Unusual Network Activity	C-9
General Problems	C-9
Prioritization Problems	C-10
IGMP-Related Problems	C-10
LACP-Related Problems	C-11
Port-Based Access Control (802.1X)-Related Problems	C-12
Radius-Related Problems	C-15
Spanning-Tree Protocol (STP) and Fast-Uplink Problems	C-16
SSH-Related Problems	C-17
Stacking-Related Problems	C-18
TACACS-Related Problems	C-18
TimeP, SNTP, or Gateway Problems	C-20
VLAN-Related Problems	C-20
Using Logging To Identify Problem Sources	C-23
Event Log Operation	C-23
Menu: Entering and Navigating in the Event Log	C-25
CLI:	C-26
Debug and Syslog Operation	C-27
Diagnostic Tools	C-34
Port Auto-Negotiation	C-34
Ping and Link Tests	C-35
Web: Executing Ping or Link Tests	C-36
CLI: Ping or Link Tests	C-37

**Troubleshooting
Contents**

Displaying the Configuration File	C-39
CLI: Viewing the Configuration File	C-39
Web: Viewing the Configuration File	C-39
Listing Switch Configuration and Operation Details for Help in Troubleshooting	C-40
CLI Administrative and Troubleshooting Commands	C-42
Restoring the Factory-Default Configuration	C-43
Using the CLI	C-43
Using the Clear/Reset Buttons	C-43
Restoring a Flash Image	C-44

Overview

This chapter addresses performance-related network problems that can be caused by topology, switch configuration, and the effects of other devices or their configurations on switch operation. (For switch-specific information on hardware problems indicated by LED behavior, cabling requirements, and other potential hardware-related problems, refer to the installation guide you received with the switch.)

Note

ProCurve periodically places switch software updates on the ProCurve web site. ProCurve recommends that you check this web site for software updates that may have fixed a problem you are experiencing.

For information on support and warranty provisions, see the Support and Warranty booklet shipped with the switch.

Troubleshooting Approaches

Use these approaches to diagnose switch problems:

- **Check the ProCurve web site** – the web site may have software updates or other information to help solve your problem:
<http://www.procurve.com>
- **Check the switch LEDs** – The LEDs on the switch are a fundamental diagnostic tool. They provide indications of proper switch operation and of any hardware faults that may have occurred:

- Each switch port has a Link LED that should light whenever an active network device is connected to the port.
- Problems with the switch hardware and software are indicated by flashing the Fault and other switch LEDs.

See the *Installation Guide* shipped with the switch for a description of the LED behavior and information on using the LEDs for troubleshooting.

- **Check the network topology/installation** – See the *Installation Guide* shipped with the switch for topology information.

- **Check the network cables** – Cabling problems are a frequent cause of network faults. Check the cables for damage, correct type, and proper connections. You should also use a cable tester to check your cables for compliance to the relevant IEEE 802.3 specification. See the *Installation Guide* shipped with the switch for correct cable types and connector pin-outs.
- **Use the software tools:**
 - **Web Browser Interface** – Use the Port Utilization Graph and Alert Log in the web browser interface included in the switch to help isolate problems. See Chapter 5, “Using the Web Browser Interface” for operating information. These tools are available through the web browser interface:
 - Port Utilization Graph
 - Alert Log
 - Port Status and Port Counters screens
 - Diagnostic tools (Link test, Ping test, configuration file browser)
 - **Switch Console** – For help in isolating problems, use the easy-to-access switch console built into the switch or Telnet to the switch console. See chapter 2, “Using the Menu Interface” and chapter 3, “Using the Command Line Interface (CLI)” for console operation information. These tools are available through the switch console:
 - Status and Counters screens
 - Event Log
 - Diagnostics tools (Link test, Ping test, configuration file browser, and advanced user commands)
 - **ProCurve Manager / ProCurve Manager +** – Use ProCurve Manager to help isolate problems and recommend solutions.

Chassis Over-Temperature Detection

- i. If a switch reaches an over-temperature condition, it generates a chassis-module Warning message in the Event Log and in any optionally configured debug destinations (console session and SyslogD servers). If the switch later returns to its acceptable temperature range, it signals this event with a chassis module Information message to the same destinations. These messages include the number of times the switch has detected the events since the last reboot. For example, suppose that you notice the following three messages at the end of the current Event Log message listing:

```
W 08/17/06 11:28:05 chassis: Over-temperature detected. Failures: 1
I 08/17/06 11:33:23 chassis: Temperature back to normal. Failures: 1
W 08/17/06 12:03:18 chassis: Over-temperature detected. Failures: 2
```

Figure C-1. Chassis Over-Temperature Messaging

The above messages indicate that the switch detected the following chassis conditions since the last reboot:

1. 16
2. An over-temperature condition occurred on August 17, 2003 at 11:28:05, meaning the switch was operating above its acceptable, internal temperature range. The Failure value of "1" indicates this is the first over-temperature condition to occur since the last reboot.
3. The switch returned to its acceptable temperature range at 11:33:23 on the same day. (To determine this temperature range, refer to the *Installation and Getting Started Guide* shipped with the switch.)
4. Another over-temperature condition occurred on August 17th at 12:03:18 and the switch is currently operating in this condition. The Failure value of "2" indicates this is the second over-temperature condition to occur since the last reboot.

CAUTION

If an over-temperature condition occurs, continued operation can result in damage to the device.

- Check the event log for fan failure warnings. If the switch has experienced a fan failure, remove power from the switch and contact your ProCurve service and support representative.

Troubleshooting

Chassis Over-Temperature Detection

- If there are no fan failures, ensure that the ambient temperature in the switch's operating area is not causing the over-temperature condition. If the condition persists, remove power from the switch until you can find the cause and apply an effective remedy.
-

Browser or Telnet Access Problems

Cannot access the web browser interface:

- Access may be disabled by the **Web Agent Enabled** parameter in the switch console. Check the setting on this parameter by selecting:

2. Switch Configuration . . .

1. System Information

- The switch may not have the correct IP address, subnet mask or gateway. Verify by connecting a console to the switch's Console port and selecting:

2. Switch Configuration . . .

5. IP Configuration

Note: If DHCP/Bootp is used to configure the switch, the IP addressing can be verified by selecting:

1. Status and Counters . . .

2. Switch Management Address Information

also check the DHCP/Bootp server configuration to verify correct IP addressing.

- If you are using DHCP to acquire the IP address for the switch, the IP address "lease time" may have expired so that the IP address has changed. For more information on how to "reserve" an IP address, refer to the documentation for the DHCP application that you are using.
- If one or more IP-Authorized managers are configured, the switch allows web browser access only to a device having an authorized IP address. For more information on IP Authorized managers, see the *Access Security Guide* for your switch.
- Java™ applets may not be running on the web browser. They are required for the switch web browser interface to operate correctly. See the online Help on your web browser for how to run the Java applets.

Cannot Telnet into the switch console from a station on the network:

- Telnet access may be disabled by the **Inbound Telnet Enabled** parameter in the System Information screen of the menu interface:

2. Switch Configuration

1. System Information

- The switch may not have the correct IP address, subnet mask, or gateway. Verify by connecting a console to the switch's Console port and selecting:

2. Switch Configuration

5. IP Configuration

Note: If DHCP/Bootp is used to configure the switch, see the **Note**, above.

- If you are using DHCP to acquire the IP address for the switch, the IP address "lease time" may have expired so that the IP address has changed. For more information on how to "reserve" an IP address, refer to the documentation for the DHCP application that you are using.
- If one or more IP-Authorized managers are configured, the switch allows inbound telnet access only to a device having an authorized IP address. For more information on IP Authorized managers, see the *Access Security Guide* for your switch.

Unusual Network Activity

Network activity that fails to meet accepted norms may indicate a hardware problem with one or more of the network components, possibly including the switch. Such problems can also be caused by a network loop or simply too much traffic for the network as it is currently designed and implemented. Unusual network activity is usually indicated by the LEDs on the front of the switch or measured with the switch console interface or with a network management tool such as the ProCurve Manager. Refer to the *Installation Guide* you received with the switch for information on using LEDs to identify unusual network activity.

A topology loop can also cause excessive network activity. The event log “FFI” messages can be indicative of this type of problem.

General Problems

The network runs slow; processes fail; users cannot access servers or other devices. Broadcast storms may be occurring in the network. These may be due to redundant links between nodes.

- If you are configuring a port trunk, finish configuring the ports in the trunk before connecting the related cables. Otherwise you may inadvertently create a number of redundant links (i.e. topology loops) that will cause broadcast storms.
- Turn on Spanning Tree Protocol to block redundant links (i.e. topology loops)
- Check for FFI messages in the Event Log.

Duplicate IP Addresses. This is indicated by this Event Log message:

ip: Invalid ARP source: IP address on IP address

where: both instances of IP address are the same address, indicating the switch’s IP address has been duplicated somewhere on the network.

Duplicate IP Addresses in a DHCP Network. If you use a DHCP server to assign IP addresses in your network and you find a device with a valid IP address that does not appear to communicate properly with the server or other devices, a duplicate IP address may have been issued by the server. This can occur if a client has not released a DHCP-assigned IP address after the intended expiration time and the server “leases” the address to another device.

This can also happen, for example, if the server is first configured to issue IP addresses with an unlimited duration, then is subsequently configured to issue IP addresses that will expire after a limited duration. One solution is to configure “reservations” in the DHCP server for specific IP addresses to be assigned to devices having specific MAC addresses. For more information, refer to the documentation for the DHCP server.

One indication of a duplicate IP address in a DHCP network is this Event Log message:

ip: Invalid ARP source: IP address on IP address

where: both instances of IP address are the same address, indicating the IP address that has been duplicated somewhere on the network.

The Switch Has Been Configured for DHCP/Bootp Operation, But Has Not Received a DHCP or Bootp Reply. When the switch is first configured for DHCP/Bootp operation, or if it is rebooted with this configuration, it immediately begins sending request packets on the network. If the switch does not receive a reply to its DHCP/Bootp requests, it continues to periodically send request packets, but with decreasing frequency. Thus, if a DHCP or Bootp server is not available or accessible to the switch when DHCP/Bootp is first configured, the switch may not immediately receive the desired configuration. After verifying that the server has become accessible to the switch, reboot the switch to re-start the process.

Prioritization Problems

Ports configured for non-default prioritization (level 1 - 7) are not performing the specified action. If the ports were placed in a trunk group after being configured for non-default prioritization, the priority setting was automatically reset to zero (the default). Ports in a trunk group operate only at the default priority setting.

IGMP-Related Problems

IP Multicast (IGMP) Traffic That Is Directed By IGMP Does Not Reach IGMP Hosts or a Multicast Router Connected to a Port. IGMP must be enabled on the switch and the affected port must be configured for “Auto” or “Forward” operation.

IP Multicast Traffic Floods Out All Ports; IGMP Does Not Appear To Filter Traffic. The IGMP feature does not operate if the switch or VLAN does not have an IP address configured manually or obtained through DHCP/Bootp. To verify whether an IP address is configured for the switch or VLAN, do either of the following:

- **Try Using the Web Browser Interface:** If you can access the web browser interface, then an IP address is configured.
- **Try To Telnet to the Switch Console:** If you can Telnet to the switch, then an IP address is configured.
- **Using the Switch Console Interface:** From the Main Menu, check the Management Address Information screen by clicking on

1. Status and Counters

2. Switch Management Address Information

LACP-Related Problems

Unable to enable LACP on a port with the **interface [e] < port-number > lacp** command. In this case, the switch displays the following message:

```
Operation is not allowed for a trunked port.
```

You cannot enable LACP on a port while it is configured as a static **Trunk** port. To enable LACP on a static-trunked port: first use the **no trunk [e] < port-number >** command to disable the static trunk assignment, and then execute **interface [e] < port-number > lacp**.

Caution

Removing a port from a trunk without first disabling the port can create a traffic loop that can slow down or halt your network. Before removing a port from a trunk, ProCurve recommends that you either disable the port or disconnect it from the LAN.

Port-Based Access Control (802.1X)-Related Problems

Note

To list the 802.1X port-access Event Log messages stored on the switch, use **show log 802**.

See also “Radius-Related Problems” on page C-15.

The switch does not receive a response to RADIUS authentication requests. In this case, the switch will attempt authentication using the secondary method configured for the type of access you are using (console, Telnet, or SSH).

There can be several reasons for not receiving a response to an authentication request. Do the following:

- Use **ping** to ensure that the switch has access to the configured RADIUS servers.
- Verify that the switch is using the correct encryption key (RADIUS secret key) for each server.
- Verify that the switch has the correct IP address for each RADIUS server.
- Ensure that the **radius-server timeout** period is long enough for network conditions.

The switch does not authenticate a client even though the RADIUS server is properly configured and providing a response to the authentication request. If the RADIUS server configuration for authenticating the client includes a VLAN assignment, ensure that the VLAN exists as a static VLAN on the switch. See “How 802.1X Authentication Affects VLAN Operation” in the *Access Security Guide* for your switch.

During RADIUS-authenticated client sessions, access to a VLAN on the port used for the client sessions is lost. If the affected VLAN is configured as untagged on the port, it may be temporarily blocked on that port during an 802.1X session. This is because the switch has temporarily assigned another VLAN as untagged on the port to support the client access, as specified in the response from the RADIUS server. See “How 802.1X Authentication Affects VLAN Operation” in the *Access Security Guide* for your switch.

The switch appears to be properly configured as a supplicant, but cannot gain access to the intended authenticator port on the switch to which it is connected. If `aaa authentication port-access` is configured for Local, ensure that you have entered the local *login* (operator-level) username and password of the authenticator switch into the **identity** and **secret** parameters of the supplicant configuration. If instead, you enter the enable (manager-level) username and password, access will be denied.

The supplicant statistics listing shows multiple ports with the same authenticator MAC address. The link to the authenticator may have been moved from one port to another without the supplicant statistics having been cleared from the first port. Refer to the “Note on Supplicant Statistics” in the *Access Security Guide* for your switch.

The `show port-access authenticator <port-list>` command shows one or more ports remain open after they have been configured with **control unauthorized**. 802.1X is not active on the switch. After you execute `aaa port-access authenticator active`, all ports configured with **control unauthorized** should be listed as **Closed**.

```
ProCurve(config)# show port-access authenticator e A9
Port Access Authenticator Status
Port-access authenticator activated [No] : No
Access Authenticator Authenticator
Port Status Control State Backend State
-----
A9 Open FU Force Auth Idle

ProCurve(config)# aaa port-access authenticator active

ProCurve(config)# show port-access authenticator e A9
Port Access Authenticator Status
Port-access authenticator activated [No] : Yes
Access Authenticator Authenticator
Port Status Control State Backend State
-----
A9 Closed FU Force Unauth Idle
```

PortA9 shows an “Open” status even though Access Control is set to **Unauthorized** (Force Auth). This is because the port-access authenticator has not yet been activated.

Figure C-2. Example of a Port Remaining Open After Being Configured with “Control Unauthorized”

RADIUS server fails to respond to a request for service, even though the server’s IP address is correctly configured in the switch. Use `show radius` to verify that the encryption key (RADIUS secret key) the switch is using is correct for the server being contacted. If the switch has only a global key configured, then it either must match the server key or you must configure

a server-specific key. If the switch already has a server-specific key assigned to the server's IP address, then it overrides the global key and must match the server key.

```
10.33.18.119(config)# show radius
Status and Counters - General RADIUS Information
Deadtime(min) : 0
Timeout(secs) : 5
Retransmit Attempts : 3
Global Encryption Key : My-Global-Key

Server IP Addr  Auth  Acct  Encryption Key
-----
10.33.18.119   1812  1813  119-only-key
```

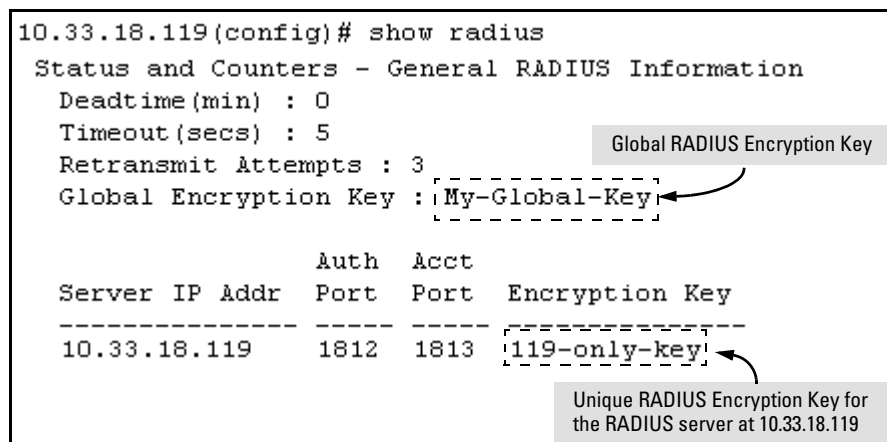

Figure C-3. Example of How To List the Global and Server-Specific Radius Encryption Keys

Also, ensure that the switch port used to access the RADIUS server is not blocked by an 802.1X configuration on that port. For example, **show port-access authenticator <port-list>** gives you the status for the specified ports. Also, ensure that other factors, such as port security or any 802.1X configuration on the RADIUS server are not blocking the link.

The authorized MAC address on a port that is configured for both 802.1X and port security either changes or is re-acquired after execution of `aaa port-access authenticator <port-list> initialize`. If the port is force-authorized with `aaa port-access authenticator <port-list> control authorized` command and port security is enabled on the port, then executing **initialize** causes the port to clear the learned address and learn a new address from the first packet it receives after you execute **initialize**.

A trunked port configured for 802.1X is blocked. If you are using RADIUS authentication and the RADIUS server specifies a VLAN for the port, the switch allows authentication, but blocks the port. To eliminate this problem, either remove the port from the trunk or reconfigure the RADIUS server to avoid specifying a VLAN.

Radius-Related Problems

The switch does not receive a response to RADIUS authentication requests. In this case, the switch will attempt authentication using the secondary method configured for the type of access you are using (console, Telnet, or SSH).

There can be several reasons for not receiving a response to an authentication request. Do the following:

- Use **ping** to ensure that the switch has access to the configured RADIUS server.
- Verify that the switch is using the correct encryption key for the designated server.
- Verify that the switch has the correct IP address for the RADIUS server.
- Ensure that the **radius-server timeout** period is long enough for network conditions.
- Verify that the switch is using the same UDP port number as the server.

RADIUS server fails to respond to a request for service, even though the server's IP address is correctly configured in the switch. Use **show radius** to verify that the encryption key the switch is using is correct for the server being contacted. If the switch has only a global key configured, then it either must match the server key or you must configure a server-specific key. If the switch already has a server-specific key assigned to the server's IP address, then it overrides the global key and must match the server key.

```

10.33.18.119(config)# show radius
Status and Counters - General RADIUS Information
  Deadtime(min) : 0
  Timeout(secs) : 5
  Retransmit Attempts : 3
  Global Encryption Key : My-Global-Key

Server IP Addr      Auth  Acct
                   Port  Port Encryption Key
-----
10.33.18.119      1812 1813 119-only-key
  
```

Figure C-4. Examples of Global and Unique Encryption Keys

Spanning-Tree Protocol (STP) and Fast-Uplink Problems

Caution

If you enable STP, it is recommended that you leave the remainder of the STP parameter settings at their default values until you have had an opportunity to evaluate STP performance in your network. Because incorrect STP settings can adversely affect network performance, you should avoid making changes without having a strong understanding of how STP operates. To learn the details of STP operation, refer to the IEEE 802.1D standard.

Broadcast Storms Appearing in the Network. This can occur when there are physical loops (redundant links) in the topology. Where this exists, you should enable STP on all bridging devices in the topology in order for the loop to be detected.

STP Blocks a Link in a VLAN Even Though There Are No Redundant Links in that VLAN. In 802.1Q-compliant devices such as the switches covered by this guide, STP blocks redundant physical links even if they are in separate VLANs. A solution is to use only one, multiple-VLAN (tagged) link between the devices. Also, if ports are available, you can improve the bandwidth in this situation by using a port trunk. See the chapter on VLANs in the *Advanced Traffic Management Guide*.

Fast-Uplink Troubleshooting. Some of the problems that can result from incorrect usage of Fast-Uplink STP include temporary loops and generation of duplicate packets.

Problem sources can include:

- Fast-Uplink is configured on a switch that is the STP root device.
- Either the **Hello Time** or the **Max Age** setting (or both) is too long on one or more switches. Return the **Hello Time** and Max Age settings to their default values (2 seconds and 20 seconds, respectively, on a switch).
- A “downlink” port is connected to a switch that is further away (in hop count) from the root device than the switch port on which fast-uplink STP is configured.
- Two edge switches are directly linked to each other with a fast-uplink (Mode = **Uplink**) connection.
- Fast uplink is configured on both ends of a link.
- A switch serving as a backup STP root switch has ports configured for fast-uplink STP and has become the root device due to a failure in the original root device.

SSH-Related Problems

Switch access refused to a client. Even though you have placed the client's public key in a text file and copied the file (using the **copy tftp pub-key-file** command) into the switch, the switch refuses to allow the client to have access. If the source SSH client is an SSHv2 application, the public key may be in the PEM format, which the switch (SSHv1) does not interpret. Check the SSH client application for a utility that can convert the PEM-formatted key into an ASCII-formatted key.

Executing ip ssh does not enable SSH on the switch. The switch does not have a host key. Verify by executing `show ip host-public-key`. If you see the message

```
ssh cannot be enabled until a host key is configured
(use 'crypto' command).
```

then you need to generate an SSH key pair for the switch. To do so, execute **crypto key generate**. (Refer to “Generating the Switch's Public and Private Key Pair” in the *Access Security Guide* for your switch.)

Switch does not detect a client's public key that does appear in the switch's public key file (show ip client-public-key). The client's public key entry in the public key file may be preceded by another entry that does not terminate with a new line (CR). In this case, the switch interprets the next sequential key entry as simply a comment attached to the preceding key entry. Where a public key file has more than one entry, ensure that all entries terminate with a new line (CR). While this is optional for the last entry in the file, not adding a new line to the last entry creates an error potential if you either add another key to the file at a later time or change the order of the keys in the file.

An attempt to copy a client public-key file into the switch has failed and the switch lists one of the following messages:

```
Download failed: overlength key in key file.
```

```
Download failed: too many keys in key file.
```

```
Download failed: one or more keys is not a valid RSA
public key.
```

The public key file you are trying to download has one of the following problems:

- A key in the file is too long. The maximum key length is 1024 characters, including spaces. This could also mean that two or more keys are merged together instead of being separated by a <CR><LF>.
- There are more than ten public keys in the key file.
- One or more keys in the file is corrupted or is not a valid rsa public key.

Client ceases to respond (“hangs”) during connection phase. The switch does not support data compression in an SSH session. Clients will often have compression turned on by default, but will disable it during the negotiation phase. A client which does not recognize the compression-request FAILURE response may fail when attempting to connect. Ensure that compression is turned off before attempting a connection to prevent this problem.

Stacking-Related Problems

The Stack Commander Cannot Locate any Candidates. Stacking operates on the primary VLAN, which in the default configuration is the DEFAULT_VLAN. However, if another VLAN has been configured as the primary VLAN, and the Commander is not on the primary VLAN, then the Commander will not detect Candidates on the primary VLAN.

TACACS-Related Problems

Event Log. When troubleshooting TACACS+ operation, check the switch’s Event Log for indications of problem areas.

All Users Are Locked Out of Access to the Switch. If the switch is functioning properly, but no username/password pairs result in console or Telnet access to the switch, the problem may be due to how the TACACS+ server and/or the switch are configured. Use one of the following methods to recover:

- Access the TACACS+ server application and adjust or remove the configuration parameters controlling access to the switch.
- If the above method does not work, try eliminating configuration changes in the switch that have not been saved to flash (boot-up configuration) by causing the switch to reboot from the boot-up configuration (which includes only the configuration changes made prior to the last **write memory** command.) If you did not use **write**

memory to save the authentication configuration to flash, then pressing the Reset button or cycling the power reboots the switch with the boot-up configuration.

- Disconnect the switch from network access to any TACACS+ servers and then log in to the switch using either Telnet or direct console port access. Because the switch cannot access a TACACS+ server, it will default to local authentication. You can then use the switch's local Operator or Manager username/password pair to log on.
- As a last resort, use the Clear/Reset button combination to reset the switch to its factory default boot-up configuration. Taking this step means you will have to reconfigure the switch to return it to operation in your network.

No Communication Between the Switch and the TACACS+ Server Application. If the switch can access the server device (that is, it can **ping** the server), then a configuration error may be the problem. Some possibilities include:

- The server IP address configured with the switch's `tacacs-server host` command may not be correct. (Use the switch's **show tacacs-server** command to list the TACACS+ server IP address.)
- The encryption key configured in the server does not match the encryption key configured in the switch (by using the **tacacs-server key** command). Verify the key in the server and compare it to the key configured in the switch. (Use **show tacacs-server** to list the global key. Use **show config** or **show config running** to list any server-specific keys.)
- The accessible TACACS+ servers are not configured to provide service to the switch.

Access Is Denied Even Though the Username/Password Pair Is Correct. Some reasons for denial include the following parameters controlled by your TACACS+ server application:

- The account has expired.
- The access attempt is through a port that is not allowed for the account.
- The time quota for the account has been exhausted.
- The time credit for the account has expired.

- The access attempt is outside of the time frame allowed for the account.
- The allowed number of concurrent logins for the account has been exceeded

For more help, refer to the documentation provided with your TACACS+ server application.

Unknown Users Allowed to Login to the Switch. Your TACACS+ application may be configured to allow access to unknown users by assigning them the privileges included in a *default user* profile. Refer to the documentation provided with your TACACS+ server application.

System Allows Fewer Login Attempts than Specified in the Switch Configuration. Your TACACS+ server application may be configured to allow fewer login attempts than you have configured in the switch with the **aaa authentication num-attempts** command.

TimeP, SNTP, or Gateway Problems

The Switch Cannot Find the Time Server or the Configured Gateway .

TimeP, SNTP, and Gateway access are through the primary VLAN, which in the default configuration is the DEFAULT_VLAN. If the primary VLAN has been moved to another VLAN, it may be disabled or does not have ports assigned to it.

VLAN-Related Problems

Monitor Port. When using the monitor port in a multiple VLAN environment, the switch handles broadcast, multicast, and unicast traffic output from the monitor port as follows:

- If the monitor port is configured for tagged VLAN operation on the same VLAN as the traffic from monitored ports, the traffic output from the monitor port carries the same VLAN tag.
- If the monitor port is configured for untagged VLAN operation on the same VLAN as the traffic from the monitored ports, the traffic output from the monitor port is untagged.
- If the monitor port is not a member of the same VLAN as the traffic from the monitored ports, traffic from the monitored ports does not go out the monitor port.

None of the devices assigned to one or more VLANs on an 802.1Q-compliant switch are being recognized. If multiple VLANs are being used on ports connecting 802.1Q-compliant devices, inconsistent VLAN IDs may have been assigned to one or more VLANs. For a given VLAN, the same VLAN ID must be used on all connected 802.1Q-compliant devices.

Link Configured for Multiple VLANs Does Not Support Traffic for One or More VLANs. One or more VLANs may not be properly configured as “Tagged” or “Untagged”. A VLAN assigned to a port connecting two 802.1Q-compliant devices must be configured the same on both ports. For example, VLAN_1 and VLAN_2 use the same link between switch “X” and switch “Y”.

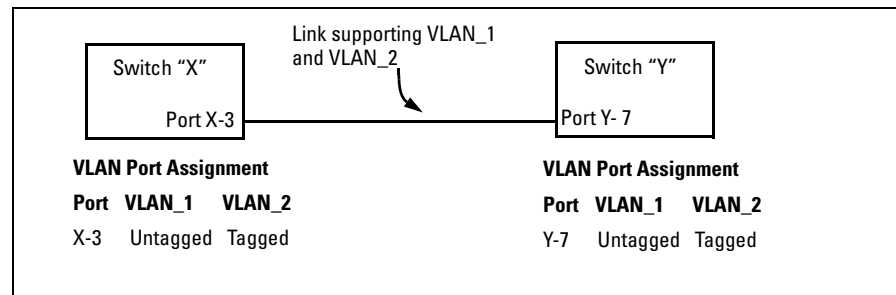

Figure C-5. Example of Correct VLAN Port Assignments on a Link

1. If VLAN_1 (VID=1) is configured as “Untagged” on port 3 on switch “X”, then it must also be configured as “Untagged” on port 7 on switch “Y”. Make sure that the VLAN ID (VID) is the same on both switches.
2. Similarly, if VLAN_2 (VID=2) is configured as “Tagged on the link port on switch “A”, then it must also be configured as “Tagged” on the link port on switch “B”. Make sure that the VLAN ID (VID) is the same on both switches.

Duplicate MAC Addresses Across VLANs. The switch operates with multiple forwarding databases. Thus, duplicate MAC addresses occurring on different VLANs can appear where a device having one MAC address is a member of more than one 802.1Q VLAN, and the switch port to which the device is linked is using VLANs (instead of STP or trunking) to establish redundant links to another switch. If the other device sends traffic over multiple VLANs, its MAC address will consistently appear in multiple VLANs on the switch port to which it is linked.

Note that attempting to create redundant paths through the use of VLANs will cause problems with some switches. One symptom is that a duplicate MAC address appears in the Port Address Table of one port, and then later appears on another port. While the switch has multiple forwarding databases, and thus does not have this problem, some switches with a single forwarding database for all VLANs may produce the impression that a connected device is moving among ports because packets with the same MAC address but different VLANs are received on different ports. You can avoid this problem by creating redundant paths using port trunks or spanning tree.

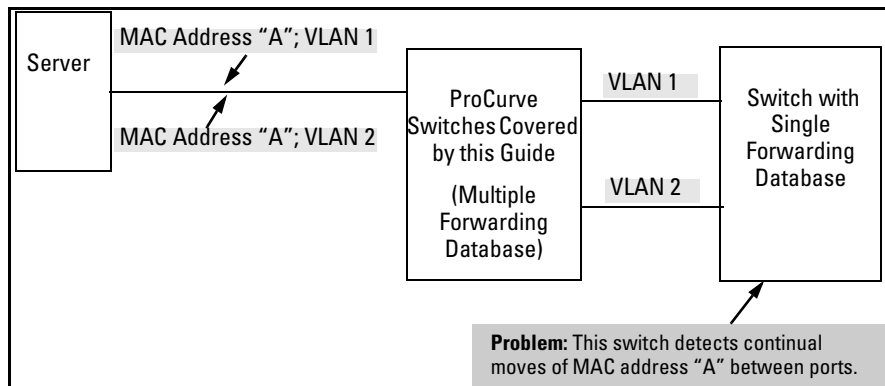

Figure C-6. Example of Duplicate MAC Address

Using Logging To Identify Problem Sources

Event Log Operation

The Event Log records operating events as single-line entries listed in chronological order, and serves as a tool for isolating problems. Each Event Log entry is composed of five fields:

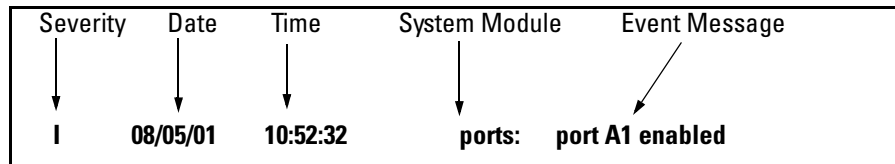

Figure C-7. Anatomy of an Event Log Message

Severity is one of the following codes:

- I** (information) indicates routine events.
- W** (warning) indicates that a service has behaved unexpectedly.
- C** (critical) indicates that a severe switch error has occurred.
- D** (debug) reserved for internal diagnostic information.

Date is the date in *mm/dd/yy* format that the entry was placed in the log.

Time is the time in *hh:mm:ss* format that the entry was placed in the log.

System Module is the internal module (such as “ports” for port manager) that generated the log entry. If VLANs are configured, then a VLAN name also appears for an event that is specific to an individual VLAN. Table C-1 on page C-24 lists the individual modules.

Event Message is a brief description of the operating event.

The event log holds up to 1000 lines in chronological order, from the oldest to the newest. Each line consists of one complete event message. Once the log has received 1000 entries, it discards the current oldest line each time a new line is received. The event log window contains 14 log entry lines and can be positioned to any location in the log.

The event log will be *erased* if power to the switch is interrupted.

(The event log is *not* erased by using the **Reboot Switch** command in the Main Menu.)

Table C-1.Event Log System Modules

Module	Event Description	Module	Event Description
addrMgr	Address table	mgr	Console management
chassis	switch hardware	ports	Change in port status; static trunks
bootp	bootp addressing	snmp	SNMP communications
console	Console interface	stack	Stacking
dhcp	DHCP addressing	stp	Spanning Tree
download	file transfer	sys, system	Switch management
FFI	Find, Fix, and Inform -- available in the console event log and web browser interface alert log	telnet	Telnet activity
garp	GARP/GVRP	tcp	Transmission control
igmp	IP Multicast	tftp	File transfer for new OS or config.
ip	IP-related	timep	Time protocol
ipx	Novell Netware	vlan	VLAN operations
lacp	Dynamic LACP trunks	Xmodem	Xmodem file transfer

Menu: Entering and Navigating in the Event Log

From the Main Menu, select **Event Log**.

```

Terminal - SWITCH.TRM
File Edit Settings Phone Transfers Help
-----
                DEFAULT_CONFIG
-----
=====  CONSOLE - MANAGER MODE  =====
I 05/01/02 11:45:22 chassis: Power Supply OK: Supply: RPS, Failures: 0 __
I 05/01/02 11:45:22 stp: Spanning Tree Protocol enabled
I 05/01/02 11:45:22 ip: entity enabled
I 05/01/02 11:45:22 tftp: entity enabled
I 05/01/02 11:45:22 bootp: entity enabled
I 05/01/02 11:45:22 tcp: configuration complete
I 05/01/02 11:45:22 tcp: entity enabled
I 05/01/02 11:45:23 telnet: Inbound telnet enabled
I 05/01/02 11:45:23 telnet: Outbound telnet enabled
I 05/01/02 11:45:23 system: System Booted.
I 05/01/02 11:45:24 console: connection established
I 05/01/02 11:45:26 mgr: SME CONSOLE Session - MANAGER Mode established
-----
--- Log events stored in memory 171-270. Log events on screen 258-270.
-----
Actions->  Back   Next page   Prev page   End   Help
-----
Return to previous screen.
Use up/down arrow scroll log one line, left/right arrow keys to
change action selection, and <Enter> to execute action.

```

Figure C-8. Example of an Event Log Display

The *log status line* at the bottom of the display identifies where in the sequence of event messages the display is currently positioned.

To display various portions of the Event Log, either preceding or following the currently visible portion, use either the actions listed at the bottom of the display (**Next page**, **Prev page**, or **End**), or the keys described in the following table:

Table C-2. Event Log Control Keys

Key	Action
[N]	Advance the display by one page (next page).
[P]	Roll back the display by one page (previous page).
↓	Advance display by one event (down one line).
↑	Roll back display by one event (up one line).
[E]	Advance to the end of the log.
[H]	Display Help for the event log.

CLI:

Using the CLI, you can list

- Events recorded since the last boot of the switch
- All events recorded
- Event entries containing a specific keyword, either since the last boot or all events recorded

Syntax: show logging [-a] [<search-text>]

```
ProCurve> show logging
           Lists recorded log messages since last reboot.
```

```
ProCurve> show logging -a
           Lists all recorded log messages, including those before the
           last reboot.
```

```
ProCurve> show logging -a system
           Lists log messages with "system" in the text or module
           name.
```

```
ProCurve> show logging system
           Lists all log messages since the last reboot that have
           "system" in the text or module name.
```

Debug and Syslog Operation

You can direct switch debug (Event log) messages to these destinations:

- Up to six SyslogD servers
- One management-access session through:
 - A direct-connect RS-232 console CLI session
 - A Telnet session
 - An SSH session

```
ProCurve(Config)# debug destination session
ProCurve(Config)# EVNT I 01/01/06 05:03:45 ports: port 17 is now off-line
EVNT I 01/01/06 05:03:45 vlan: VLAN_20 virtual LAN disabled
EVNT I 01/01/06 05:03:45 ip: VLAN_20: network disabled on 10.255.120.1
EVNT I 01/01/06 05:03:47 ports: port 18 is now Blocked by LACP
EVNT I 01/01/06 05:03:49 ports: port 18 is now on-line
ENVNT I 01/01/06 05:03:49 vlan: VLAN_20 virtual LAN enabled
EVNT I 01/01/06 05:03:50 ip: VLAN_20: network enabled on 10.255.120.1 1
```

Figure C-9. Example of Debug Output to a Console CLI Session

Debug logging requires a logging destination (SyslogD server and/or a session type), and involves the **logging** and **debug destination** commands. Actions you can perform with Debug and Syslog operation include:

- Configure the switch to send Event Log messages to one or more SyslogD servers. Included is the option to send the messages to the **user** log facility (default) on the configured servers, or to another log facility.

Note

As of April, 2006, the **logging facility < facility-name >** option (described on page C-29) is available on the switches covered in this guide.

For the latest feature information on ProCurve switches, visit the ProCurve web site and check the latest release notes for the switch products you use.

- Configure the switch to send Event Log messages to the current management-access session (serial-connect CLI, Telnet CLI, or SSH).
- Disable all Syslog debug logging while retaining the Syslog addresses from the switch configuration. This allows you to configure Syslog messaging and then disable and re-enable it as needed.
- Display the current debug configuration. If Syslog logging is currently active, this includes the Syslog server list.
- Display the current Syslog server list when Syslog logging is disabled.

Debug Types. This section describes the types of debug messages the switch can send to configured debug destinations.

Syntax: [no] debug < debug-type >

all

Configures the switch to send all debug types to the configured debug destination(s). (Default: Disabled)

event

*Configures the switch to send Event Log messages to the configured debug destination(s). **Note:** This has no effect on event notification messages the switch routinely sends to the Event Log itself. Also, this debug type is automatically enabled in these cases:*

- *If there is currently no Syslog server address configured and you use **logging < ip-addr >** to configure an address.*
- *If there is currently at least one Syslog server address configured and the switch is rebooted or reset.*

(Default: Disabled)

port-access-auth

If 802.1X authentication is configured, this option shows the various communication messages sent between the switch, client, and RADIUS server.

(Default: Disabled)

Configuring the Switch To Send Debug Messages to One or More SyslogD Servers. Use the logging command to configure the switch to send Syslog messages to a SyslogD server, or to remove a SyslogD server from the switch configuration.

Syntax: [no] logging < syslog-ip-address | facility < facility-name >>
< syslog-ip-address >

*If there are no SyslogD servers configured, **logging** enters a SyslogD server IP address **and** automatically enables Syslog logging to the server. If at least one SyslogD server is already configured and Syslog logging has been disabled, you can still use **logging** < syslog-ip-addr > to add another SyslogD server, but Syslog logging remains disabled until you re-enable it with the **debug destination logging** command. While Syslog logging is enabled, the switch attempts to send Syslog messages to all configured SyslogD server addresses, and operates regardless of whether session logging is also enabled. To configure multiple SyslogD servers, repeat the command once for each server IP address. (**Default:** none; **Range:** Up to six IP addresses)*

facility < facility-name >

Specifies the destination subsystem the SyslogD server(s) must use. (All SyslogD servers must use the same subsystem.) ProCurve recommends the default (user) subsystem unless your application specifically requires another subsystem. Options include:

- user** (the default) - Various user-level messages
- kern** - Kernel messages
- mail** - Mail system
- daemon** - system daemons
- auth** - security/authorization messages
- syslog** - messages generated internally by Syslog
- lpr** - line printer subsystem
- news** - netnews subsystem
- uucp** - uucp subsystem
- cron** - cron/at subsystem
- sys9** - cron/at subsystem
- sys10 through sys14** - Reserved for system use
- local0 through local7** - Reserved for system use

*(Some switches covered by this manual do not offer the facility option. Refer to the **Note** on page C-27.)*

Troubleshooting

Using Logging To Identify Problem Sources

For example, on a switch where there are no SyslogD servers configured, you would do the following to configure SyslogD servers 18.120.38.155 and 18.120.43.125 and automatically enable Syslog logging (with **user** as the default logging facility):

logging <syslog-ip-addr>
configures the Syslog server(s) to use and enables Syslog debug logging. (In this case, Syslog is automatically enabled because debug destination logging has not been previously disabled with other Syslog servers already configured in the switch. (Refer to the Syntax box under "Configuring the Switch To Send Debug Messages to One or More SyslogD Servers" on page C-29.)

```
ProCurve(config)# logging 18.120.38.155
ProCurve(config)# logging 18.120.43.125
ProCurve(config)# write mem
ProCurve(config)# show config
```

Startup configuration:

```
; J9022A Configuration Editor; Created on release #N.10.XX
hostname "ProCurve switch"

cdp run
module 1 type J4862A
ip default-gateway 18.38.224.1
ip routing
logging 18.120.38.155
logging 18.120.43.125
snmp-server community "public" Unrestricted
vlan 1
  name "DEFAULT_VLAN"
  :
ProCurve(config)# show debug
Debug Logging
Destination:
Logging --
 18.120.38.155
 18.120.43.125
Facility = user
Enabled debug types:
event
```

The configured Syslog server IP addresses appear in the switch's configuration file.

This command shows that Syslog logging is enabled for the listed IP addresses.

Default Logging Facility

Figure C-10. Example of Configuring and Enabling Syslog Logging

To use a non-default logging facility, such as **lpr**, in the same operation as in figure C-10, you would use this command set:

```
ProCurve(config)# logging 18.120.38.155
ProCurve(config)# logging 18.120.43.125
ProCurve(config)# logging facility lpr
```

Enabling or Disabling Logging to Management Sessions and SyslogD Servers. Use this command when you want to do any of the following:

- Disable Syslog logging on all currently configured SyslogD servers without removing the servers from the switch configuration.
- Re-enable Syslog logging if it is disabled and there is at least one SyslogD server currently configured in the switch.
- Enable or disable logging output to the current management-access session.

Syntax: [no] debug destination < logging | session >

logging

*The **no** form of the command disables Syslog logging, but retains the currently configured SyslogD server addresses in the switch configuration. When Syslog logging is currently disabled with one or more SyslogD servers configured, this command enables Syslog logging on the switch. The **show config** command output includes the SyslogD server IP addresses currently configured in the startup-config file.*

session

*Enables and disables debug logging to the current session. The “current session” is the session that most recently executed **debug destination session** on the switch (since the last reboot). This makes it easy to move session logging from one session to another.*

For example, figure C-11 shows the process for checking the current Syslog status and then disabling Syslog logging.

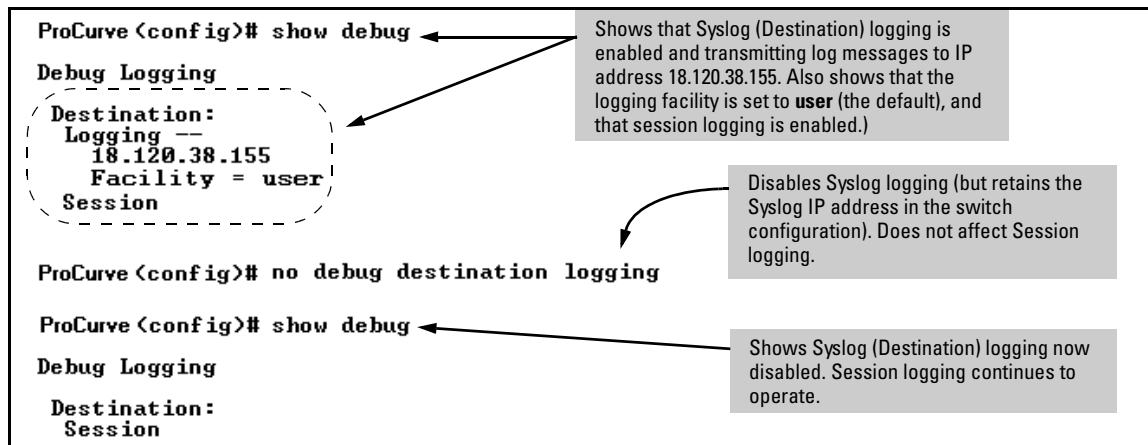

Figure C-11. Example of Disabling Syslog Operation

Viewing Debug (Syslog and Session) Status. Use these commands to determine the current debug configuration and status:

Syntax: show < config | running >

Lists the current startup-config or running-config file, with any currently configured IP addresses for SyslogD servers.

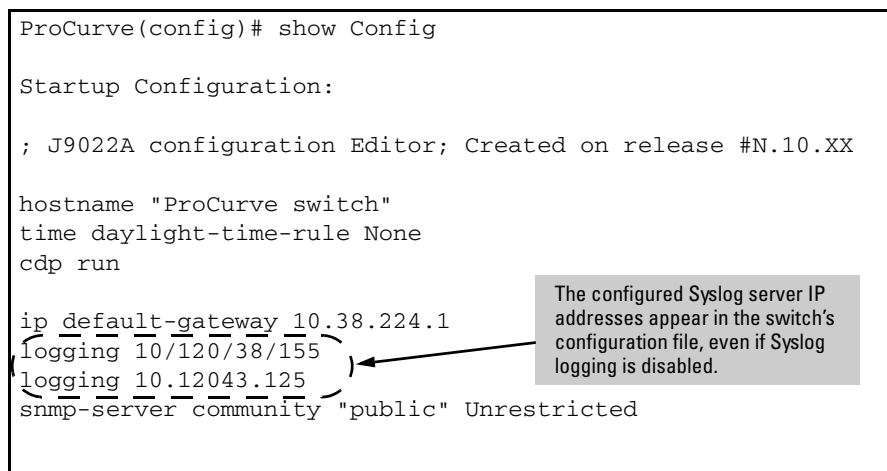

Figure C-12. Example of Show Config Output with SyslogD Servers Configured

Syntax: show debug

List the current debug status for both Syslog logging and Session logging.

```

ProCurve <config># show debug
Debug Logging
Destination:
Logging --
 18.120.38.155
Facility = user
Session -- Not Current One
    
```

Shows that Syslog logging is enabled and sending event messages to the **user** facility on the SyslogD server at IP address 18.120.38.155.

Shows that session logging is operating through another session. (You can take control of session logging by executing **debug destination session** in the session you are currently using.)

Figure C-13. Example of Show Debug Status

- **Rebooting the Switch or pressing the Reset button resets the Debug Configuration.**

Debug Option	Effect of a Reboot or Reset
logging (destination)	If any SyslogD server IP addresses are in the startup-config file, they are saved across a reboot and the logging destination option remains enabled. Otherwise, the logging destination is disabled.
Session (destination)	Disabled
All (event type)	Disabled
Event (event type)	If a Syslog server is configured in the startup-config file, resets to enabled, regardless of prior setting. Disabled if no Syslog server is configured.
port-access-auth (event type)	Disabled

- **Debug commands do not affect message output to the Event Log.** As a separate option, invoking debug with the **event** option causes the switch to send Event Log messages to whatever debug destination(s) you configure (session and/or logging), as well as to the Event Log.

- **Ensure that your Syslog server(s) will accept Debug messages.** All Syslog messages the switch generates carry the configured facility. All Syslog messages resulting from debug operation carry a “debug” severity. If you configure the switch to transmit debug messages to a SyslogD server, ensure that the server’s Syslog application is configured to accept the “debug” severity level. (The default configuration for some Syslog applications ignores the “debug” severity level.)
- **A reboot temporarily suspends Syslog logging.** After a reboot, the switch suspends configured Syslog logging for 30 seconds.

Diagnostic Tools

Diagnostic Features

Feature	Default	Menu	CLI	Web
Port Autonegotiation	n/a	n/a	n/a	n/a
Ping Test	n/a	—	page C-37	page C-36
Link Test	n/a	—	page C-37	page C-36
Display Config File	n/a	—	page C-39	page C-39
Admin. and Troubleshooting Commands	n/a	—	page C-42	—
Factory-Default Config	page C-43 (Buttons)	—	page C-43	—
Port Status	n/a	pages B-9 and B-10	pages B-9 and B-10	pages B-9 and B-10

Port Auto-Negotiation

When a link LED does not light (indicating loss of link between two devices), the most common reason is a failure of port auto-negotiation between the connecting ports. If a link LED fails to light when you connect the switch to a port on another device, do the following:

1. Ensure that the switch port and the port on the attached end-node are both set to **Auto** mode.

2. If the attached end-node does not have an **Auto** mode setting, then you must manually configure the switch port to the same setting as the end-node port. See Chapter 10, “Port Status and Basic Configuration”.

Ping and Link Tests

The Ping test and the Link test are point-to-point tests between your switch and another IEEE 802.3-compliant device on your network. These tests can tell you whether the switch is communicating properly with another device.

Note

To respond to a Ping test or a Link test, the device you are trying to reach must be IEEE 802.3-compliant.

Ping Test. This is a test of the path between the switch and another device on the same or another IP network that can respond to IP packets (ICMP Echo Requests).

Link Test. This is a test of the connection between the switch and a designated network device on the same LAN (or VLAN, if configured). During the link test, IEEE 802.2 test packets are sent to the designated network device in the same VLAN or broadcast domain. The remote device must be able to respond with an 802.2 Test Response Packet.

Web: Executing Ping or Link Tests

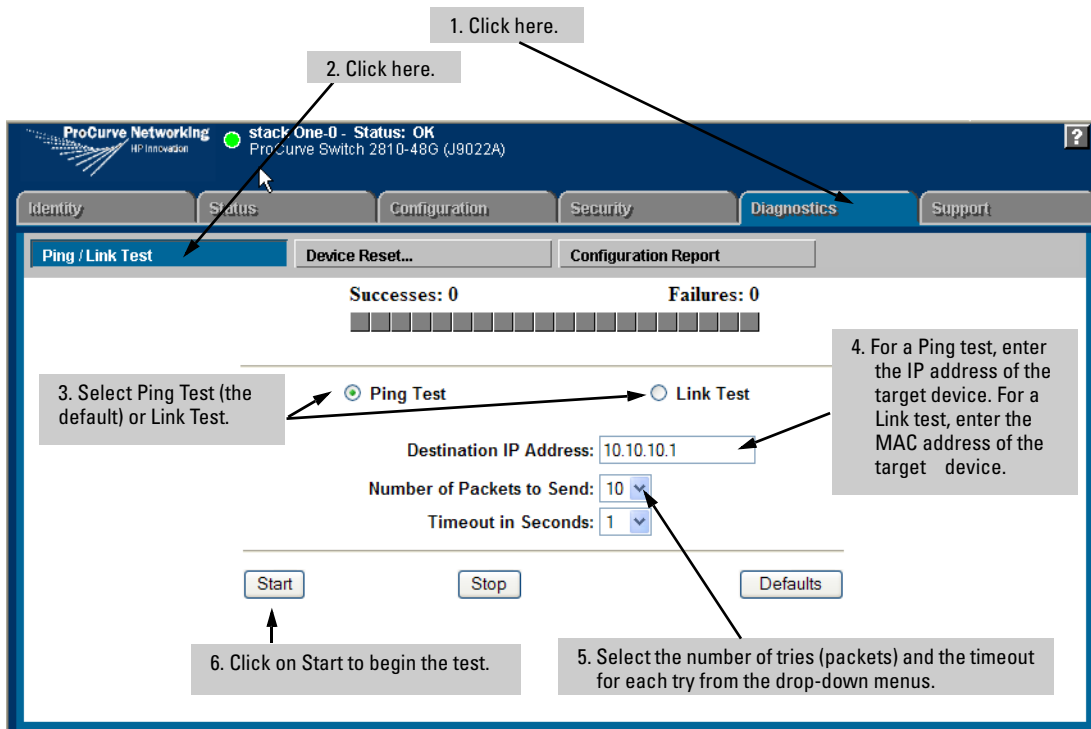

Figure C-14. Link and Ping Test Screen on the Web Browser Interface

Successes indicates the number of Ping or Link packets that successfully completed the most recent test.

Failures indicates the number of Ping or Link packets that were unsuccessful in the last test. Failures indicate connectivity or network performance problems (such as overloaded links or devices).

Destination IP/MAC Address is the network address of the target, or destination, device to which you want to test a connection with the switch. An IP address is in the X.X.X.X format where X is a decimal number between 0 and 255. A MAC address is made up of 12 hexadecimal digits, for example, 0060b0-080400.

Number of Packets to Send is the number of times you want the switch to attempt to test a connection.

Timeout in Seconds is the number of seconds to allow per attempt to test a connection before determining that the current attempt has failed.

To halt a Link or Ping test before it concludes, click on the Stop button.
To reset the screen to its default settings, click on the Defaults button.

CLI: Ping or Link Tests

Ping Tests. You can issue single or multiple ping tests with varying repetitions and timeout periods. The defaults and ranges are:

- Repetitions: 1 (1 - 999)
- Timeout: 5 seconds (1 - 256 seconds)

Syntax: ping < ip-address > [repetitions < 1 - 999 >] [timeout < 1 - 256 >]

Basic Ping Operation	→	ProCurve>ping 10.28.227.103 10.28.227.103 is alive, time = 15 ms
Ping with Repetitions	→	ProCurve>ping 10.28.227.103 repetitions 3 10.28.227.103 is alive, iteration 1, time = 15 ms 10.28.227.103 is alive, iteration 2, time = 15 ms 10.28.227.103 is alive, iteration 3, time = 15 ms
Ping with Repetitions and Timeout	→	ProCurve>ping 10.28.227.103 repetitions 3 timeout 2 10.28.227.103 is alive, iteration 1, time = 15 ms 10.28.227.103 is alive, iteration 2, time = 10 ms 10.28.227.103 is alive, iteration 3, time = 15 ms
Ping Failure	↘	ProCurve> ping 10.28.227.105 Target did not respond.

Figure C-15. Examples of Ping Tests

To halt a ping test before it concludes, press **[Ctrl] [C]**.

Link Tests. You can issue single or multiple link tests with varying repetitions and timeout periods. The defaults are:

- Repetitions: 1 (1 - 999)
- Timeout: 5 seconds (1 - 256 seconds)

Syntax: link < mac-address > [repetitions < 1 - 999 >] [timeout < 1 - 256 >]
[vlan < vlan-id >]

Basic Link Test	ProCurve#link 0030c1-7fcc40 Link-test passed.
Link Test with Repetitions	ProCurve#link 0030c1-7fcc40 repetitions 3 802.2 TEST packets sent: 3, responses received: 3
Link Test with Repetitions and Timeout	ProCurve#link 0030c1-7fcc40 repetitions 3 timeout 1 802.2 TEST packets sent: 3, responses received: 3
Link Test Over a Specific VLAN	ProCurve#link 0030c1-7fcc40 repetitions 3 timeout 1 vlan 1 802.2 TEST packets sent: 3, responses received: 3
Link Test Over a Specific VLAN; Test Fail	ProCurve#link 0030c1-7fcc40 repetitions 3 timeout 1 vlan 222 802.2 TEST packets sent: 3, responses received: 0

Figure C-16. Example of Link Tests

Displaying the Configuration File

The complete switch configuration is contained in a file that you can browse from either the web browser interface or the CLI. It may be useful in some troubleshooting scenarios to view the switch configuration.

CLI: Viewing the Configuration File

Using the CLI, you can display either the running configuration or the startup configuration. (For more on these topics, see appendix C, “Switch Memory and Configuration”.)

Syntax: write terminal
 Displays the running-config file.

 show running-config
 Displays the running-config file.

 show config
 Displays the startup-config file.

Web: Viewing the Configuration File

To display the running configuration, through the web browser interface:

1. Click on the **Diagnostics** tab.
2. Click on **Configuration Report**
3. Use the right-side scroll bar to scroll through the configuration listing.

Listing Switch Configuration and Operation Details for Help in Troubleshooting

The **show tech** command outputs, in a single listing, switch operating and running configuration details from several internal switch sources, including:

- Image stamp (software version data)
- Running configuration
- Event Log listing
- Boot History
- Port settings
- Status and counters — port status
- IP routes
- Status and counters — VLAN information
- GVRP support
- Load balancing (trunk and LACP)
- Stacking status — this switch
- Stacking status — all

Syntax: show tech

Executing **show tech** outputs a data listing to your terminal emulator. However, using your terminal emulator's text capture features, you can also save **show tech** data to a text file for viewing, printing, or sending to an associate. For example, if your terminal emulator is the Hyperterminal application available with Microsoft® Windows® software, you can copy the show tech output to a file and then use either Microsoft Word or Notepad to display the data. (In this case, Microsoft Word provides the data in an easier-to-read format.)

To Copy show tech output to a Text File. This example uses the Microsoft Windows terminal emulator. To use another terminal emulator application, refer to the documentation provided with that application.

1. In Hyperterminal, click on **Transfer | Capture Text...**

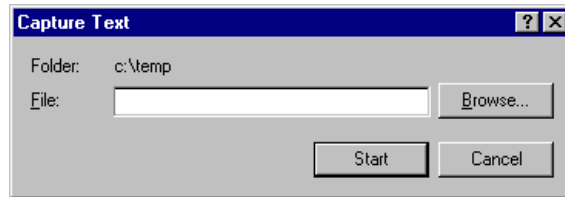

Figure C-17. The Capture Text window of the Hypertext Application Used with Microsoft Windows Software

2. In the **File** field, enter the path and file name under which you want to store the **show tech** output.

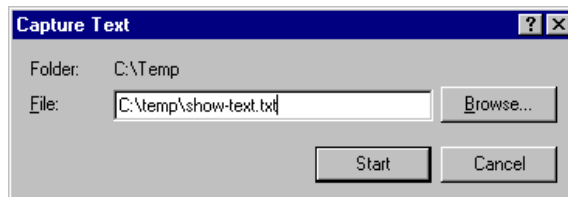

Figure C-18. Example of a Path and Filename for Creating a Text File from show tech Output

3. Click **[Start]** to create and open the text file.
4. Execute **show tech**:

```
ProCurve# show tech
```

 - a. Each time the resulting listing halts and displays -- MORE --, press the Space bar to resume the listing.
 - b. When the CLI prompt appears, the show tech listing is complete. At this point, click on **Transfer | Capture Text | Stop** in HyperTerminal to stop copying data into the text file created in the preceding steps.

Note

Remember to do the above step to stop HyperTerminal from copying into the text file. Otherwise, the text file remains open to receiving additional data from the HyperTerminal screen.

5. To access the file, open it in Microsoft Word, Notepad, or a similar text editor.

CLI Administrative and Troubleshooting Commands

These commands provide information or perform actions that you may find helpful in troubleshooting operating problems with the switch.

Note

For more on the CLI, refer to “Using the Command Line Interface (CLI)” on page 4-1.

- Syntax:** show version
Shows the software version currently running on the switch and the flash image from which the switch booted (primary or secondary).
- show boot-history
Displays the switch shutdown history.
- show history
Displays the current command history.
- [no] page
Toggles the paging mode for display commands between continuous listing and per-page listing.
- setup
Displays the Switch Setup screen from the menu interface.
- repeat
Repeatedly executes the previous command until a key is pressed.
- kill
Terminates all other active sessions.

Restoring the Factory-Default Configuration

As part of your troubleshooting process, it may become necessary to return the switch configuration to the factory default settings. This process momentarily interrupts the switch operation, clears any passwords, clears the console event log, resets the network counters to zero, performs a complete self test, and reboots the switch into its factory default configuration including deleting an IP address. There are two methods for resetting to the factory-default configuration:

- CLI
- Clear/Reset button combination

Note

ProCurve recommends that you save your configuration to a TFTP server before resetting the switch to its factory-default configuration. You can also save your configuration via Xmodem, to a directly connected PC.

Using the CLI

This command operates at any level *except* the Operator level.

Syntax: `erase startup-configuration`
Deletes the startup-config file in flash so that the switch will reboot with its factory-default configuration.

Note

The **erase startup-config** command does not clear passwords.

Using the Clear/Reset Buttons

To execute the factory default reset, perform these steps:

1. Using pointed objects, simultaneously press both the Reset and Clear buttons on the front of the switch.
2. Continue to press the Clear button while releasing the Reset button.
3. When the Self Test LED begins to flash, release the Clear button.

The switch will then complete its self test and begin operating with the configuration restored to the factory default settings.

Restoring a Flash Image

The switch can lose its operating system if either the primary or secondary flash image location is empty or contains a corrupted OS file and an operator uses the **erase flash** command to erase a good OS image file from the opposite flash location.

To Recover from an Empty or Corrupted Flash State. Use the switch's console serial port to connect to a workstation or laptop computer that has the following:

- A terminal emulator program with Xmodem capability, such as the HyperTerminal program included in Windows PC software.
- A copy of a good OS image file for the switch.

Note

The following procedure requires the use of Xmodem, and copies an OS image into primary flash only.

This procedure assumes you are using HyperTerminal as your terminal emulator. If you use a different terminal emulator, you may need to adapt this procedure to the operation of your particular emulator.

1. Start the terminal emulator program.
2. Ensure that the terminal program is configured as follows:
 - Baud rate: 9600
 - 1 stop bit
 - No parity
 - No flow control
 - 8 Bits
3. Use the Reset button to reset the switch. The following prompt should then appear in the terminal emulator:

```
Enter h or ? for help.
```

```
=>
```

4. Since the OS file is large, you can increase the speed of the download by changing the switch console and terminal emulator baud rates to a high speed. For example:

- a. Change the switch baud rate to 115,200 Bps.

```
=> sp 115200
```

- b. Change the terminal emulator baud rate to match the switch speed:
 - i. In HyperTerminal, select **Call | Disconnect**.
 - ii. Select **File | Properties**.
 - iii. Click on **Configure . . .**
 - iv. Change the baud rate to **115200**.
 - v. Click on **[OK]**. In the next window, click on **[OK]** again.
 - vi. Select **Call | Connect**
 - vii. Press **[Enter]** one or more times to display the => prompt.

5. Start the Console Download utility by typing **do** at the => prompt and pressing **[Enter]**:

```
=> do
```

6. You will then see this prompt:

```
You have invoked the console download utility.  
Do you wish to continue? (Y/N)>_
```

7. At the above prompt:
 - a. Type **y** (for Yes)
 - b. Select **Transfer | File** in HyperTerminal.
 - c. Enter the appropriate filename and path for the OS image.
 - d. Select the **Xmodem** protocol (and not the 1k Xmodem protocol).
 - e. Click on **[Send]**.

If you are using HyperTerminal, you will see a screen similar to the following to indicate that the download is in progress:

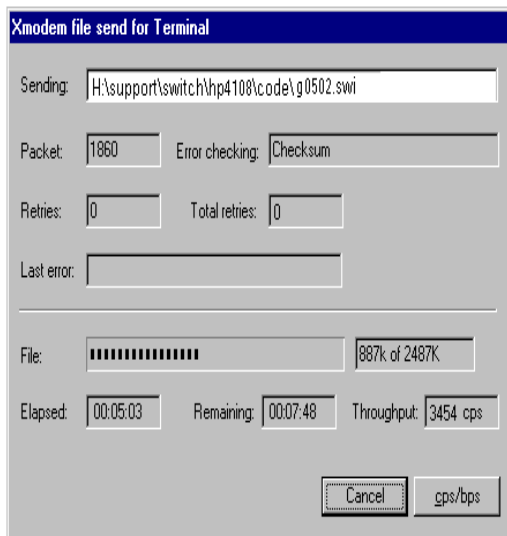

Figure C-19. Example of Xmodem Download in Progress

8. When the download completes, the switch reboots from primary flash using the OS image you downloaded in the preceding steps, plus the most recent startup-config file.

MAC Address Management

Contents

Overview	D-2
Determining MAC Addresses in the Switch	D-2
Menu: Viewing the Switch's MAC Addresses	D-3
CLI: Viewing the Port and VLAN MAC Addresses	D-4
Viewing the MAC Addresses of Connected Devices	D-6

Overview

The switch assigns MAC addresses in these areas:

- For management functions:
 - One Base MAC address assigned to the default VLAN (VID = 1)
 - Additional MAC address(es) corresponding to additional VLANs you configure in the switch
- For internal switch operations: One MAC address per port (See “CLI: Viewing the Port and VLAN MAC Addresses” on page D-4.)

MAC addresses are assigned at the factory. The switch automatically implements these addresses for VLANs and ports as they are added to the switch.

Note

The switch’s base MAC address is also printed on a label affixed to the back of the switch.

Determining MAC Addresses in the Switch

MAC Address Viewing Methods

Feature	Default	Menu	CLI	Web
view switch’s base (default vlan) MAC address and the addressing for any added VLANs	n/a	D-3	D-4	—
view port MAC addresses(hexadecimal format)	n/a	—	D-4	—

- **Use the menu interface** to view the switch’s base MAC address and the MAC address assigned to any non-default VLAN you have configured on the switch.

Note

The switch’s base MAC address is used for the default VLAN (VID = 1) that is always available on the switch.

- Use the **CLI** to view the switch's port MAC addresses in hexadecimal format.

Menu: Viewing the Switch's MAC Addresses

The Management Address Information screen lists the MAC addresses for:

- Base switch (default VLAN; VID = 1)
- Any additional VLANs configured on the switch.

Also, the Base MAC address appears on a label on the back of the switch.

Note

The Base MAC address is used by the first (default) VLAN in the switch. This is usually the VLAN named "DEFAULT_VLAN" unless the name has been changed (by using the VLAN Names screen). On the switches covered by this guide, the VID (VLAN identification number) for the default VLAN is always "1", *and cannot be changed*.

To View the MAC Address (and IP Address) assignments for VLANs Configured on the Switch:

1. From the Main Menu, Select

1. Status and Counters

2. Switch Management Address Information

If the switch has only the default VLAN, the following screen appears. If the switch has multiple static VLANs, each is listed with its address data.

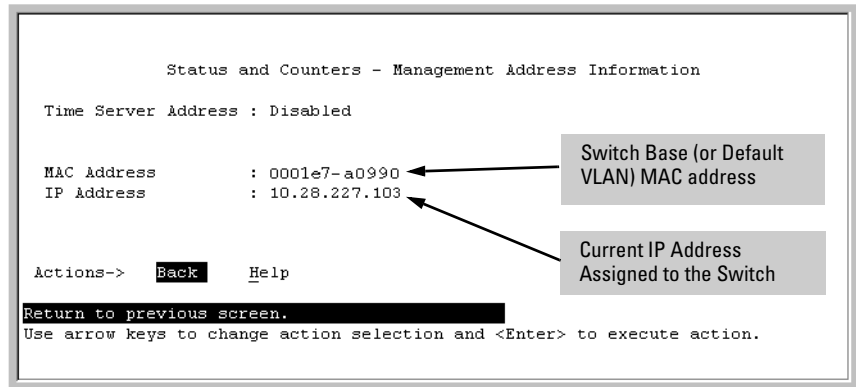

Figure D-1. Example of the Management Address Information Screen

CLI: Viewing the Port and VLAN MAC Addresses

The MAC address assigned to each switch port is used internally by such features as Flow Control and the Spanning Tree Protocol. Using the **walkmib** command to determine the MAC address assignments for individual ports can sometimes be useful when diagnosing switch operation.

The switch allots 24 MAC addresses per slot. For a given slot, if a three-port module is installed, then the switch uses the first three MAC addresses in the allotment for slot 1, and the remaining 21 MAC addresses are unused. If a six-port module is installed, the switch uses the first six MAC addresses in the allotment, and so-on. The switch's base MAC address is assigned to VLAN (VID) 1 and appears in the **walkmib** listing after the MAC addresses for the ports. If multiple VLANs are configured, the MAC addresses assigned to these VLANs appear after the base MAC address.

To display the switch's MAC addresses, use the **walkmib** command at the command prompt:

Note

This procedure displays the MAC addresses for all ports and existing VLANs in the switch, regardless of which VLAN you select.

1. If the switch is at the CLI Operator level, use the **enable** command to enter the Manager level of the CLI.
2. Type the following command to display the MAC address for each port on the switch:

```
ProCurve# walkmib ifPhysAddress
```

(The above command is not case-sensitive.)

For example, with a six-port module in slot 1, a three-port module in slot 3, and three VLANs present:

ProCurve# walkmib ifPhysAddress	
ifPhysAddress.1 = 00 01 e7 a0 99 ff	ifPhysAddress.1 - 6: Ports A1 - A6 in Slot 1 (Addresses 7 - 24 in slot 1 and 25 - 48 in slot 2 are unused.)
ifPhysAddress.2 = 00 01 e7 a0 99 fe	
ifPhysAddress.3 = 00 01 e7 a0 99 fd	
ifPhysAddress.4 = 00 01 e7 a0 99 fc	
ifPhysAddress.5 = 00 01 e7 a0 99 fb	
ifPhysAddress.6 = 00 01 e7 a0 99 fa	
ifPhysAddress.49 = 00 01 e7 a0 99 cf	ifPhysAddress.49 - 51: Ports C1 - C3 in Slot 3 (Addresses 52 - 72 in slot 3 are unused.)
ifPhysAddress.50 = 00 01 e7 a0 99 ce	
ifPhysAddress.51 = 00 01 e7 a0 99 cd	ifPhysAddress.205 Base MAC Address (MAC Address for default VLAN; VID = 1)
ifPhysAddress.205 = 00 01 e7 a0 99 00	
ifPhysAddress.226 = 00 01 e7 a0 99 01	ifPhysAddress.226 & 237 MAC Addresses for non-default VLANs.
ifPhysAddress.237 = 00 01 e7 a0 99 02	

Figure D-2. Example of Port MAC Address Assignments

Viewing the MAC Addresses of Connected Devices

Syntax: show mac-address [*mac-addr*]

Lists the MAC addresses of the devices the switch has detected, along with the number of the specific port on which each MAC address was detected.

[*port-list*]

Lists the MAC addresses of the devices the switch has detected, on the specified port(s).

[*mac-addr*]

Lists the port on which the switch detects the specified MAC address. Returns the following message if the specified MAC address is not detected on any port in the switch:

MAC address <*mac-addr*> not found.

[vlan < *vid* >]

Lists the MAC addresses of the devices the switch has detected on ports belonging to the specified VLAN, along with the number of the specific port on which each MAC address was detected.

To list the MAC addresses of devices the switch has detected, use the **show mac-address** command. For example,

```
ProCurve(config)# show mac-address

Status and Counters - Port Address Table

MAC Address      Located on Port
-----
001e6-09620c     1
0001e7-61d4c0    2
0001e7-6025c0    3
```

Figure D-3. Displaying MAC Addresses Detected by a Switch

MAC Address Management

Viewing the MAC Addresses of Connected Devices

Daylight Savings Time on ProCurve Switches

Configuring Daylight Savings Time

This information applies to the following ProCurve switches:

- 2510
- 2512
- 2524
- 2626
- 2650
- 2626-PWR
- 2650-PWR
- 2810
- 2824
- 2848
- 3400cl
- 4108gl
- 4104gl
- 6108
- 5304xl
- 5308xl
- 1600M
- 2400M
- 2424M
- 4000M
- 8000M
- 212M
- 224M
- ProCurve AdvanceStack Switches
- ProCurve AdvanceStack Routers

ProCurve switches provide a way to automatically adjust the system clock for Daylight Savings Time (DST) changes. To use this feature you define the month and date to begin and to end the change from standard time. In addition to the value "none" (no time changes), there are five pre-defined settings, named:

- Alaska
- Canada and Continental US
- Middle Europe and Portugal
- Southern Hemisphere
- Western Europe

The pre-defined settings follow these rules:

Alaska:

- Begin DST at 2am on the second Sunday in March.
- End DST at 2am on the first Sunday in November.

Daylight Savings Time on ProCurve Switches
Configuring Daylight Savings Time

Canada and Continental US:

- Begin DST at 2am on the second Sunday in March.
- End DST at 2am on the first Sunday in November.

Middle Europe and Portugal:

- Begin DST at 2am the first Sunday on or after March 25th.
- End DST at 2am the first Sunday on or after September 24th.

Southern Hemisphere:

- Begin DST at 2am the first Sunday on or after October 25th.
- End DST at 2am the first Sunday on or after March 1st.

Western Europe:

- Begin DST at 2am the first Sunday on or after March 23rd.
- End DST at 2am the first Sunday on or after October 23rd.

A sixth option named "User defined" allows you to customize the DST configuration by entering the beginning month and date plus the ending month and date for the time change. The menu interface screen looks like this (all month/date entries are at their default values):

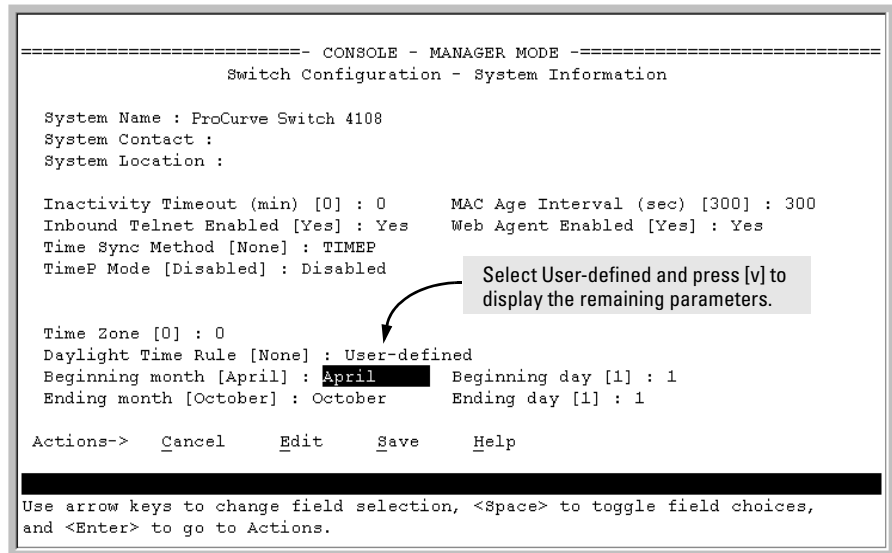

Figure E-1. Menu Interface with "User-Defined" Daylight Time Rule Option

Before configuring a "User defined" Daylight Time Rule, it is important to understand how the switch treats the entries. The switch knows which dates are Sundays, and uses an algorithm to determine on which date to change the system clock, given the configured "Beginning day" and "Ending day":

- If the configured day is a Sunday, the time changes at 2am on that day.
- If the configured day is not a Sunday, the time changes at 2am on the first Sunday after the configured day.

This is true for both the "Beginning day" and the "Ending day".

With that algorithm, one should use the value "1" to represent "first Sunday of the month", and a value equal to "number of days in the month minus 6" to represent "last Sunday of the month". This allows a single configuration for every year, no matter what date is the appropriate Sunday to change the clock.

Daylight Savings Time on ProCurve Switches
Configuring Daylight Savings Time

Index

Symbols

=> prompt ... C-44

Numerics

802.1X

LLDP blocked ... 12-32

802.1X effect, LLDP ... 12-50

A

access

manager ... 12-13

operator ... 12-13

Actions line ... 3-9, 3-10, 3-11

location on screen ... 3-9

address table, port ... B-13

address, network manager ... 12-4, 12-5

alert log ... 5-20

alert types ... 5-21

disabling ... 5-25

setting the sensitivity level ... 5-24

sorting the entries ... 5-20

applicable products ... 1-ii

asterisk ... 3-10, 3-13

authentication trap ... 12-20, 12-23

See also SNMP.

authentication trap, configuring ... 12-23

authorized IP managers

SNMP, blocking ... 12-3

auto MDI/MDI-X configuration, display ... 10-14

auto MDI/MDI-X operation ... 10-14

auto MDI/MDI-X port mode, display ... 10-14

auto negotiation ... 10-4

Auto-10 ... 11-3, 11-7

auto-discovery ... 12-5

B

bandwidth

displaying utilization ... 5-17

boot

effect on configuration ... 3-13

See also reboot.

boot ROM console ... A-3

boot ROM mode ... C-44

Bootp

Bootp table file ... 8-14

Bootptab file ... 8-14

effect of no reply ... C-9

operation ... 8-13

using with Unix systems ... 8-13

Bootp/DHCP, LLDP ... 12-40

broadcast limit ... 10-5, 10-12

broadcast storm ... C-16

browser interface

See web browser interface.

C

CDP

configuration, viewing ... 12-53

data collection ... 12-52

default CDP operation ... 12-52

disabled ... 12-52

general operation ... 12-53

mappings to LLDP data fields ... 12-51

neighbor devices ... 12-52

neighbors table ... 12-54

on individual ports ... 12-55

read-only operation ... 12-51, 12-52

chassis over-temperature

See temperature

Class of Service

priority settings mapped to downstream

devices ... 10-29

Clear button ... 5-11

restoring factory default configuration ... C-43

CLI

context level ... 10-11

command line interface

See CLI.

communities, SNMP ... 12-14

viewing and configuring with the CLI ... 12-16

viewing and configuring with the menu ... 12-14

configuration ... 3-7

Bootp ... 8-14

comparing startup to running ... 6-5

- console ... 7-3
- copying ... A-18
- download ... A-3
- factory default ... 6-8, 8-2
- IP ... 8-3
- network monitoring ... B-23
- permanent ... 6-6
- permanent change defined ... 6-4
- port ... 10-1, 11-1
- port trunk groups ... 10-1, 11-1
- quick ... 3-8
- reboot to activate ... 3-13
- restoring factory defaults ... C-43
- saving from menu interface ... 3-10
- serial link ... 7-3
- SNMP ... 12-4, 12-5, 12-12
- SNMP communities ... 12-14, 12-16
- startup ... 3-10
- system ... 7-11
- Telnet access configuration ... 7-3
- transferring ... A-18
- trap receivers ... 12-20
- viewing ... 6-5
- web browser access ... 7-3
- configuration file
 - browsing for troubleshooting ... C-39
- console ... C-9
 - configuring ... 7-3
 - ending a session ... 3-5
 - features ... 2-3
 - Main menu ... 3-7
 - navigation ... 3-9, 3-10
 - operation ... 3-10
 - starting a session ... 3-4
 - status and counters access ... 3-7
 - troubleshooting access problems ... C-7
- context level
 - global config ... 8-11
- copyright ... 1-ii
- CPU utilization ... B-6

D

- date format ... C-23
- date, configure ... 7-15
- debug command
 - "debug" severity and Syslog servers ... C-34
 - event ... C-28

- event log ... C-33
- syntax ... C-28
- debug logging
 - configuration, viewing ... C-32
 - general operation ... C-27
 - session, not current ... C-33
 - status, viewing ... C-32
 - Syslog configuration ... C-29
 - Syslog logging disabled ... C-29
 - Syslog server, view configuration ... C-32
 - Syslog, number of servers ... C-27
 - Telnet session ... C-27
- debug logging, LLDP ... 12-30
- default gateway ... 8-3
- default trunk type ... 11-10
- Device Passwords Window ... 5-8
- DHCP
 - address problems ... C-9
 - effect of no reply ... C-9
- DHCP/Bootp
 - operation ... 8-12
 - process ... 8-12
- DHCP/Bootp, LLDP ... 12-40
- diagnostics tools ... C-34
 - browsing the configuration file ... C-39
 - ping and link tests ... C-35
- disclaimer ... 1-ii
- DNS name ... 5-4
- Domain Name Server ... 5-4
- download
 - switch-to-switch ... A-14
 - troubleshooting ... A-17
 - Xmodem ... A-11
- download OS ... A-14
- download, TFTP ... A-3, A-4
- downstream device (QoS)
 - effect of priority settings ... 10-29
- duplicate MAC address
 - See MAC address
- Dyn1
 - See LACP.

E

- Emergency Location Identification Number ... 12-26
- ending a console session ... 3-5
- event log ... 3-7, C-23
 - navigation ... C-25

See also debug logging.
severity level ... C-23
temperature messages ... C-5
use during troubleshooting ... C-23
with debug ... C-33
excessive packets ... 10-24

F

factory default configuration
restoring ... 6-8, C-43
failure, OS download ... A-17
fan failure ... C-5
fault detection ... 5-8
policy ... 5-8
setting the policy ... 5-23
window ... 5-23
fault detection policy ... 5-23
fault-tolerance ... 11-4
filter, source-port ... 10-23
firmware version ... B-6
flash memory ... 3-10, 6-2
flow control ... 10-5
jumbo packets ... 10-18, 10-22
flow control, status ... B-10
flow control, terminal ... 7-3
format, date ... C-23
format, time ... C-23
friendly port names
See port names, friendly.

G

gateway ... 8-3, 8-5
gateway (IP) address ... 8-4, 8-6
giant packets ... 10-24
global config level, CLI ... 8-11

H

Help ... 3-11, 5-13
Help line
location on menu screen ... 3-9
help, online inoperable ... 5-13

I

IEEE 802.1d ... C-16

IEEE 802.3ab ... 10-4
IEEE P802.1AB/D9 ... 12-31
IGMP
host not receiving ... C-10
not working ... C-10
statistics ... B-19
inactivity timeout ... 7-4
Inbound Telnet Enabled parameter ... C-8
Inconsistent value ... 12-37
invalid input ... 4-13
IP
CLI access ... 8-7
configuration ... 8-3
DHCP/Bootp ... 8-3
duplicate address ... C-9
duplicate address, DHCP network ... C-9
effect when address not used ... 8-11
gateway ... 8-3
gateway (IP) address ... 8-4
menu access ... 8-5
multinetting ... 8-9
multiple addresses in VLAN ... 8-9
stacking ... 8-5
subnet ... 8-9
subnet mask ... 8-3, 8-6
subnetting ... 8-9
using for web browser interface ... 5-4
web access ... 8-11

IP address
for SNMP management ... 12-3
multiple in a VLAN ... 8-9
removing or replacing ... 8-10

IP preserve
DHCP server ... 8-16
overview ... 8-16
rules, operating ... 8-16
summary of effect ... 8-19

IPX
network number ... B-7

J

Java ... 5-4
Java applets ... 5-5
jumbo packets
configuration ... 10-18
excessive inbound ... 10-22
flow control ... 10-18, 10-22

- GVRP operation ... 10-18
- management VLAN ... 10-22
- maximum size ... 10-17
- MTU ... 10-17
- port adds and moves ... 10-18
- port speed ... 10-18
- security concerns ... 10-23
- standard MTU ... 10-17
- through non-jumbo ports ... 10-23
- traffic sources ... 10-18
- troubleshooting ... 10-24
- VLAN tag ... 10-17
- voice VLAN ... 10-22

K

- kill command ... 7-10

L

LACP

- 802.1x, not allowed ... 11-22
- active ... 11-15, 11-19
- CLI access ... 11-11
- default port operation ... 11-20
- described ... 11-6, 11-17
- Dyn1 ... 11-7
- dynamic ... 11-19
- enabling dynamic trunk ... 11-15
- full-duplex required ... 10-5, 11-3, 11-17
- IGMP ... 11-23
- no half-duplex ... 11-24
- operation not allowed ... C-11
- outbound traffic distribution ... 11-25
- overview ... 11-4
- passive ... 11-15, 11-19
- removing port from active trunk ... 11-16
- restrictions ... 11-22
- standby link ... 11-19
- status, terms ... 11-21
- STP ... 11-23
- VLANs ... 11-23
- with 802.1x ... 11-22
- with port security ... 11-22
- learning bridge ... 8-2
- limit, broadcast ... 10-12
- link speed, port trunk ... 11-3
- link test

- description ... C-35
- for troubleshooting ... C-35

- link, serial ... 7-3

LLDP

- 802.1D-compliant switch ... 12-50
- 802.1X blocking ... 12-32
- 802.1X effect ... 12-50
- active port ... 12-26
- adjacent device ... 12-26
- advertisement ... 12-26
- advertisement content ... 12-40
- advertisement data ... 12-42
- advertisement, mandatory data ... 12-40
- advertisement, optional data ... 12-41
- advertisements, delay interval ... 12-36
- CDP neighbor data

CDP

- LLDP neighbor data ... 12-51

- chassis ID ... 12-40
- chassis type ... 12-40
- clear statistics counters ... 12-47
- comparison with CDP data fields ... 12-51
- configuration options ... 12-28
- configuring optional data ... 12-41
- data options ... 12-29
- data read options ... 12-30
- data unit ... 12-26
- debug logging ... 12-30
- default ... 12-52
- default configuration ... 12-32
- DHCP/Bootp operation ... 12-31
- disable, per-port ... 12-39
- display neighbor data ... 12-44
- ELIN ... 12-26
- enable/disable, global ... 12-35
- features ... 12-25
- general operation ... 12-27
- global counters ... 12-47
- holdtime multiplier ... 12-36
- hub, packet-forwarding ... 12-28
- IEEE P802.1AB/D9 ... 12-31
- Inconsistent value ... 12-37
- information options ... 12-29
- invalid frames ... 12-48
- IP address advertisement ... 12-31
- IP address subelement ... 12-40
- IP address, advertisement ... 12-50
- IP address, DHCP/Bootp ... 12-40

- IP address, options ... 12-40
- IP address, version advertised ... 12-40
- LLDP-aware ... 12-26
- LLDPDU ... 12-26
- MIB ... 12-27, 12-31
- neighbor ... 12-26
- neighbor data remaining ... 12-50
- neighbor data, displaying ... 12-44
- neighbor statistics ... 12-47
- neighbor, maximum ... 12-50
- operating rules ... 12-31
- operation ... 12-27
- optional data, configuring ... 12-41
- outbound packet options ... 12-29
- packet boundaries ... 12-27
- packet dropped ... 12-28
- packet time-to-live ... 12-30
- packet-forwarding ... 12-27
- packets not forwarded ... 12-26
- per-port counters ... 12-48
- port description ... 12-41
- port ID ... 12-40
- port trunks ... 12-31
- port type ... 12-40
- refresh interval ... 12-35
- reinitialization delay ... 12-37
- remote management address ... 12-30
- remote manager address ... 12-40
- reset counters ... 12-47
- rxonly ... 12-39
- setmib, delay interval ... 12-36
- setmib, reinit delay ... 12-38
- show advertisement data ... 12-42
- show commands ... 12-32, 12-34
- show outbound advertisement ... 12-43
- SNMP notification ... 12-29
- SNMP traps ... 12-29
- spanning-tree blocking ... 12-32
- standards compatibility ... 12-31
- statistics, displaying ... 12-47
- system capabilities ... 12-41
- system description ... 12-41
- system name ... 12-41
- terminology ... 12-26
- time-to-live ... 12-28, 12-36
- TLV ... 12-27
- transmission frequency ... 12-28
- transmission interval, change ... 12-35
- transmit and receive ... 12-28
- transmit/receive modes ... 12-28
- transmit/receive modes, per-port ... 12-39
- trap notice interval ... 12-39
- trap notification ... 12-38
- trap receiver, data change notice ... 12-38
- TTL ... 12-28, 12-30
- txonly ... 12-39
- VLAN, untagged ... 12-50
- walkmib ... 12-30
- LLDPDU ... 12-26
- load balancing
 - See* port trunk.
- logical port ... 11-8
- lost password ... 5-11

M

- MAC address ... 8-13, B-6, D-2
 - duplicate ... C-16, C-21
 - learned ... B-13
 - listing connected devices ... D-6
 - port ... D-2, D-3
 - switch ... D-2
 - VLAN ... D-2
- management
 - server URL ... 5-12, 5-13
 - server URL default ... 5-13
- management VLAN
 - See* VLAN.
- manager access ... 12-13
- manager password ... 5-8, 5-10
- MDI/MDI-X configuration, display ... 10-14
- MDI/MDI-X port mode, display ... 10-14
- media type, port trunk ... 11-3
- memory
 - flash ... 3-10, 6-2
 - startup configuration ... 3-10
- menu interface
 - configuration changes, saving ... 3-10
- MIB ... 12-4
- MIB file, location on web site ... 12-4
- MIB listing ... 12-4
- MIB, HP proprietary ... 12-4
- MIB, standard ... 12-4
- mirroring
 - See* port monitoring.
- MLTS ... 12-26

- monitoring traffic ... B-23
- Multiline Telephone system ... 12-26
- multinetting ... 8-9
- multinetting, limit ... 8-9
- multiple VLAN ... 12-3
- multi-port bridge ... 8-2

N

- NANP ... 12-27
- navigation, console interface ... 3-9, 3-10
- navigation, event log ... C-25
- network management functions ... 12-5
- network manager address ... 12-4, 12-5
- network monitoring
 - traffic overload ... B-23
- Network Monitoring Port screen ... B-23
- network slow ... C-9
- North American Numbering Plan ... 12-27
- Not Current One, debug session ... C-33
- notices ... 1-ii

O

- online help ... 5-13
- online help location ... 5-13
- operation not allowed, LACP ... C-11
- operator access ... 12-13
- operator password ... 5-8, 5-10
- OS
 - version ... A-5, A-12, A-15
- OS download
 - failure indication ... A-17
 - switch-to-switch download ... A-14
 - troubleshooting ... A-17
 - using TFTP ... A-3
- out-of-band ... 2-3
- over-temperature
 - See* temperature

P

- password ... 5-8, 5-10
 - creating ... 5-8
 - delete ... 3-7, 5-11
 - if you lose the password ... 5-11
 - lost ... 5-11
 - manager ... 5-8

- operator ... 5-8
 - set ... 3-7
 - setting ... 5-9
 - using to access browser and console ... 5-10
- PD ... 12-27
- ping test
 - description ... C-35
 - for troubleshooting ... C-35
- port
 - address table ... B-13
 - auto negotiation ... 10-4
 - broadcast limit ... 10-12
 - CLI access ... 10-7
 - context level ... 10-11
 - control configuration ... 10-1, 11-1
 - counters ... B-10
 - counters, reset ... B-10
 - fiber-optic ... 10-4
 - full-duplex, LACP ... 10-5
 - MAC address ... D-3, D-4
 - menu access ... 10-5
 - queues
 - See* port-based priority.
 - traffic patterns ... B-10
 - transceiver status ... 10-9
 - trunk
 - See* port trunk.
 - utilization ... 5-17
 - web browser interface ... 5-17
 - web browser access ... 10-16
- port names, friendly
 - configuring ... 10-34
 - displaying ... 10-35
 - summary ... 10-33
- port security
 - trunk restriction ... 11-8
- port trunk ... 11-2
 - caution ... 11-9, 11-16
 - CLI access ... 11-11
 - default trunk type ... 11-10
 - enabling dynamic LACP ... 11-15
 - IGMP ... 11-8
 - LACP ... 10-5
 - LACP, full duplex required ... 11-3
 - link requirements ... 11-3
 - logical port ... 11-8
 - media requirements ... 11-7
 - media type ... 11-3

- menu access to static trunk ... 11-9
- monitor port restrictions ... 11-8
- nonconsecutive ports ... 11-2
- number of trunks ... 11-3
- port security restriction ... 11-8
- removing port from static trunk ... 11-15
- requirements ... 11-7
- SA/DA ... 11-25
- See also* LACP.
- spanning tree protocol ... 11-8
- static trunk ... 11-7
- static trunk, overview ... 11-4
- STP ... 11-8
- STP operation ... 11-7
- traffic distribution ... 11-7
- Trk1 ... 11-7
- trunk (non-protocol) option ... 11-6
- trunk option described ... 11-24
- types ... 11-6
- VLAN ... 11-8
- VLAN operation ... 11-7
- web browser access ... 11-17
- port trunk group
 - interface access ... 10-1, 11-1
- port, active ... 12-26
- port-based access control
 - event log ... C-12
 - LACP not allowed ... 11-22
 - troubleshooting ... C-12
- port-based priority
 - 802.1q VLAN tagging ... 10-28
 - configuring ... 10-31
 - messages ... 10-32
 - outbound port queues ... 10-29
 - overview ... 10-28
 - priority/queue table ... 10-29
 - requirement for continuity ... 10-30
 - rules of operation ... 10-30
 - troubleshooting ... 10-32
 - viewing configuration ... 10-31
- power interruption, effect on event log ... C-23
- ProCurve Networking
 - support URL ... 5-13
- prompt, => ... C-44
- PSAP ... 12-27
- Public Safety Answering Point ... 12-27
- public SNMP community ... 12-5
- publication data ... 1-ii

Q

- quick configuration ... 3-8
- quick start ... 1-6, 8-4

R

- reboot ... 3-8, 3-10, 3-12
 - scheduling remotely ... 6-20
- reboot, actions causing ... 6-3
- reboot, effect on configuration ... 3-13
- reconfigure ... 3-10
- reload ... 6-17, 6-19
 - at/after ... 6-20, 6-21
 - scheduled ... 6-20, 6-21
- remote session, terminate ... 7-10
- reset ... 3-12, 6-10
- Reset button
 - restoring factory default configuration ... C-43
- reset port counters ... B-10
- resetting the switch
 - factory default reset ... C-43
- restricted access ... 12-14
- restricted write access ... 12-13
- RFC
 - See* MIB.
 - RFC 1493 ... 12-4
 - RFC 1515 ... 12-4
 - RFC 2922 ... 12-31
 - RFC2737 ... 12-31
 - RFC2863 ... 12-31
 - RMON ... 12-4
- router
 - gateway ... 8-6
- RS-232 ... 2-3
- running-config, viewing ... 6-5
 - See also* configuration.

S

- scheduled reboot ... 6-20
- SCP/SFTP
 - session limit ... A-10
- secure copy
 - See* SCP/SFTP.
- secure FTP
 - See* SCP/SFTP.
- security ... 5-11, 7-3
- Self Test LED

- behavior during factory default reset ... C-43
- serial number ... B-6
- serial port connection ... 4-2
- session
 - See* debug logging.
- setmib, delay interval ... 12-36
- setmib, reinit delay ... 12-38
- setting fault detection policy ... 5-23
- setup screen ... 1-6, 8-4
- severity code, event log ... C-23
- show tech ... C-40
- slow network ... C-9
- SNMP ... 12-3
 - CLI commands ... 12-13
 - communities ... 12-4, 12-5, 12-12, 12-13, 12-14
 - configure ... 12-4, 12-5
 - IP ... 12-3
 - notification, LLDP
 - SNMP notification ... 12-29
 - public community ... 12-5, 12-14
 - restricted access ... 12-14
 - thresholds ... 12-20
 - traps ... 12-4, 12-20
 - traps, well-known ... 12-20
- SNMP communities
 - configuring with the CLI ... 12-16
 - configuring with the menu ... 12-14
- SNMP trap, LLDP ... 12-38
- SNMPv3
 - "public" community access caution ... 12-6
 - access ... 12-5
 - assigning users to groups ... 12-8
 - communities ... 12-12
 - enable command ... 12-7
 - enabling ... 12-6
 - group access levels ... 12-11, 12-12
 - groups ... 12-10
 - network management problems with snmpv3
 - only ... 12-6
 - notification ... 12-18
 - restricted-access option ... 12-6
 - set up ... 12-5
 - traps ... 12-18
 - users ... 12-5
- SNTP ... 9-3
 - broadcast mode ... 9-2, 9-9
 - broadcast mode, requirement ... 9-3
 - configuration ... 9-4
 - disabling ... 9-11
 - enabling and disabling ... 9-9
 - event log messages ... 9-24
 - menu interface operation ... 9-23
 - operating modes ... 9-2
 - poll interval ... 9-12
 - See also* TimeP.
 - selecting ... 9-3
 - unicast mode ... 9-3, 9-10
 - unicast time polling ... 9-21
 - unicast, address priority ... 9-21
 - unicast, deleting addresses ... 9-23
 - unicast, replacing servers ... 9-22
 - viewing ... 9-4, 9-8
- software version ... B-6
- sorting alert log entries ... 5-20
- source-port filter ... 10-23
- spanning tree
 - configuration ... 10-11
 - fast-uplink
 - troubleshooting ... C-16
 - global information ... B-17
 - information screen ... B-17
 - problems related to ... C-16
 - show tech, copy output ... C-40
 - statistics ... B-17
 - using with port trunking ... 11-8
 - viewing port operating statistics ... 10-11
- SSH
 - debug logging ... C-27
 - TACACS exclusion ... A-10
 - troubleshooting ... C-17
- standard MIB ... 12-4
- starting a console session ... 3-4
- startup-config, viewing ... 6-5
 - See also* configuration.
- statistics ... 3-7, B-4
- statistics, clear counters ... 3-12, 6-10
- status and counters
 - access from console ... 3-7
- status and counters menu ... B-5
- status overview screen ... 5-6
- subnet ... 8-9
- subnet mask ... 8-5, 8-6
 - See also* IP.
- subnetting ... 8-9
- support
 - changing default URL ... 5-13

- URL ... 5-12
- URL Window ... 5-12
- switch console
 - See* console.
- switch setup menu ... 3-8
- switch software
 - See* OS.
- switch-to-switch download ... A-14
- Syslog
 - facility, user ... C-34
 - See* debug logging.
 - severity, "debug" ... C-34
- system configuration screen ... 7-11
- System Name parameter ... 7-12

T

TACACS

- SSH exclusion ... A-10

tech transceivers

- show ... 10-9

Telnet ... 3-4

- terminate session, kill command ... 7-10

Telnet, enable/disable ... 7-4

Telnet, outbound ... 7-6

Telnet, problem ... C-8

temperature

- fan failure ... C-5

- messages ... C-5

terminal access, lose connectivity ... 7-7

terminal mode, changing dynamically ... 7-8

terminal type ... 7-3

terminate remote session ... 7-10

TFTP

- download ... A-4

- OS download ... A-3

threshold setting ... 12-5

thresholds, SNMP ... 12-20

time format ... C-23

time protocol

- selecting ... 9-3

time server ... 8-3

time, configure ... 7-15

TimeP ... 8-4, 8-5

- assignment methods ... 9-2

- disabling ... 9-20

- enabling and disabling ... 9-18

- poll interval ... 9-20

- selecting ... 9-3

- viewing and configuring, menu ... 9-15

- viewing, CLI ... 9-17

timesync, disabling ... 9-20

Time-To-Live ... 8-4, 8-5

time-to-live, LLDP ... 12-28

TLV ... 12-27

traffic monitoring ... 12-5, B-23

traffic, port ... B-10

transceiver

- error messages ... 10-10

- view status ... 10-9

transceiver, fiber-optic ... 10-4

trap ... 5-25

- authentication ... 12-20

- authentication trap ... 12-23

- CLI access ... 12-20

- event levels ... 12-22

- limit ... 12-20

- receiver ... 12-20

- SNMP ... 12-20

trap notification ... 12-38

trap receiver ... 12-4, 12-5

- configuring ... 12-20, 12-22

troubleshooting

- approaches ... C-3

- browsing the configuration file ... C-39

- console access problems ... C-7

- diagnosing unusual network activity ... C-9

- diagnostics tools ... C-34

- fast-uplink ... C-16

- OS download ... A-17

- ping and link tests ... C-35

- restoring factory default configuration ... C-43

- spanning tree ... C-16

- SSH ... C-17

- switch won't reboot, shows => prompt ... C-44

- unusual network activity ... C-9

- using the event log ... C-23

- web browser access problems ... C-7

trunk

- See* port trunk.

TTL ... 8-4, 8-5

TTL, LLDP ... 12-28

Type-Length-Value ... 12-27

types of alert log entries ... 5-21

U

unauthorized access ... 12-23

undersize packets ... 10-24

Universal Resource Locator

See URL.

Unix, Bootp ... 8-13

unrestricted write access ... 12-13

unusual network activity ... C-9

up time ... B-6

URL

browser interface online help location ... 5-13

management ... 5-13

management server ... 5-12, 5-13

ProCurve Networking ... 5-13

support ... 5-12, 5-13

user name, using for browser or console

access ... 5-8, 5-10

users, SNMPv3

See SNMPv3.

using the passwords ... 5-10

utilization, port ... 5-17

V

version, OS ... A-5, A-12, A-15

view

transceiver status ... 10-9

VLAN ... 8-4, C-22, D-2

address ... 12-3

Bootp ... 8-14

configuring Bootp ... 8-14

device not seen ... C-21

event log entries ... C-23

link blocked ... C-16

management and jumbo packets ... 10-22

management VLAN, SNMP block ... 12-3

monitoring ... B-3

multinetting ... 8-9

multiple ... 12-3

multiple IP addresses ... 8-9

OS download ... A-3

port configuration ... C-21

primary ... 8-4

reboot required ... 3-8

subnet ... 8-9

support enable/disable ... 3-8

tagging broadcast, multicast, and unicast

traffic ... C-20

VLAN ID ... 4-15

See also VLAN.

VT-100 terminal ... 7-3

W

walkmib ... 12-30

warranty ... 1-ii

web agent

advantages ... 2-5

enabled ... 5-2

web browser access configuration ... 7-3

web browser enable/disable ... 7-4

web browser interface

access parameters ... 5-8

alert log ... 5-6, 5-20

alert log details ... 5-21

bandwidth adjustment ... 5-18

bar graph adjustment ... 5-18

disable access ... 5-2

enabling ... 5-4

error packets ... 5-17

fault detection policy ... 5-8, 5-23

fault detection window ... 5-23

features ... 2-5

first-time install ... 5-7

first-time tasks ... 5-7

main screen ... 5-16

online help ... 5-13

online help location specifying ... 5-13

online help, inoperable ... 5-13

overview ... 5-16

Overview window ... 5-16

password lost ... 5-11

password, setting ... 5-9

port status ... 5-19

port utilization ... 5-17

port utilization and status displays ... 5-17

screen elements ... 5-16

security ... 5-2, 5-8

standalone ... 5-4

status bar ... 5-22

status indicators ... 5-23

status overview screen ... 5-6

system requirements ... 5-4

troubleshooting access problems ... C-7

URL default ... 5-13

URL, management server ... 5-14

URL, support ... 5-14
write access ... 12-13
write memory, effect on menu interface ... 3-13

X

Xmodem OS download ... A-11

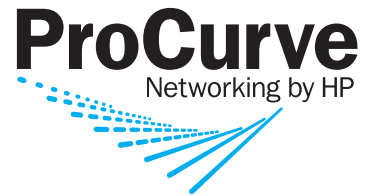

Technical information in this document
is subject to change without notice.

© Copyright 2007 Hewlett-Packard
Development Company, L.P.

Reproduction, adaptation, or translation
without prior written permission is prohibited
except as allowed under the copyright laws.

July 2007

Manual Part Number
5991-4732